



ITALJET

DRAGSTER



DRAGSTER 300

IT - Manuale Uso e Manutenzione

EN - Use and Maintenance Manual (Translation from the Original Instructions)

FR - Manuel d'utilisation et d'entretien (traduction des instructions d'origine)

ES - Manual de uso y mantenimiento (traducción de las instrucciones originales)

DE - Gebrauchs- und Wartungshandbuch (Übersetzung aus der Originalanleitung)







IT

ITALIANO

Italjet declina qualsiasi responsabilità per eventuali errori in cui può essere incorsa nella compilazione del presente manuale e si riserva il diritto di apportare qualsiasi modifica richiesta dallo sviluppo evolutivo dei propri prodotti. Le illustrazioni riportate sono indicative e potrebbero non corrispondere esattamente al particolare trattato. È vietata la riproduzione anche parziale della presente pubblicazione senza autorizzazione scritta.





DRAGSTER

A large, stylized red letter 'D' with a white outline, positioned below the word 'DRAGSTER'. The 'D' has a thick, rounded body and a white cutout in the middle.



INDICE

1.1 PRESENTAZIONE.....IT - 5	2.6 COMANDI.....IT - 19	2.14.b Vano sottosella portaoggettiIT - 27
1.2 AVVERTENZE IMPORTANTI.....IT - 5	2.6.a Bloccetto chiaveIT - 19	2.14.c Cavalletto lateraleIT - 28
1.3 SIMBOLOGIE PRESENTI NEL MANUALEIT - 6	2.6.b Bloccasterzo "lock"IT - 20	2.14.d Cavalletto centraleIT - 29
1.4 GUIDA SICURA E SICUREZZA DEL MOTOCICLO.....IT - 7	2.7 BLOCCHETTO COMANDI SINISTROIT - 21	3.1 CONTROLLI PRIMA DELL'UTILIZZO.....IT - 30
1.5 SISTEMA FRENANTE ANTIBLOCCAGGIO - ABSIT - 8	2.8 BLOCCHETTO COMANDI DESTROIT - 22	3.2 ISTRUZIONI PER L'USO DEL MOTOCICLOIT - 32
1.6 RISCHI LEGATI AL MONOSSIDO DI CARBONIO.....IT - 8	2.8.a Interruttore di EMERGENZA arresto motoreIT - 22	3.2.a Istruzioni per il rodaggio ..IT - 32
1.7 INFORMAZIONI DI SICUREZZA ..IT - 9	2.8.b Pulsante avviamento motoreIT - 22	3.2.b Individuazione degli inconvenienti di funzionamentoIT - 32
1.7.a Accessori.....IT - 9	2.9 COMANDO ACCELERATORE ...IT - 22	3.3 SALITA/DISCESA PILOTA E PASSEGGERO.....IT - 33
1.7.b Trasporto dello scooter.....IT - 9	2.10 COMANDO FRENO ANTERIORE.....IT - 23	3.3.a Norme generaliIT - 33
1.7.c Chiave ripiegabile.....IT - 9	2.11 COMANDO FRENO POSTERIOREIT - 23	3.3.b Salita del pilotaIT - 33
2.1 COMPONENTI DELLO SCOOTERIT - 10	2.12 SERBATOIO CARBURANTEIT - 24	3.3.c Salita del passeggero.....IT - 34
2.2 COMANDI E STRUMENTAZIONEIT - 13	2.12.a Rifornimento di carburanteIT - 24	3.3.d Discesa della motoIT - 35
2.3 DATI PER L'IDENTIFICAZIONEIT - 14	2.13 CARBURANTE.....IT - 25	3.4 REGOLAZIONE SPECCHIETTI RETROVISORIIT - 35
2.4 STRUMENTAZIONE.....IT - 15	2.13.a Diversi tipi di benzinaIT - 25	4.1 AVVIAMENTO DEL MOTOCICLOIT - 36
2.4.a Spie di segnalazione e avvertimento.....IT - 15	2.13.b Convertitore cataliticoIT - 26	4.1.a Uso dell'acceleratore.....IT - 37
2.4.b Strumento digitaleIT - 17	2.14 PARTI ACCESSORI E PRESA USBIT - 26	4.1.b Uso dei freniIT - 37
2.5 REGOLAZIONE E IMPOSTAZIONE DISPLAY.....IT - 18	2.14.a Per utilizzare la presa USBIT - 26	4.1.c Arresto del motociclo e del motoreIT - 38





4.1.d	Arresto del motore in emergenza	IT - 38
4.1.e	Parcheggio del motociclo	IT - 38
5.1	MANUTENZIONE E CONTROLLI PERIODICI.....	IT - 39
5.1.a	Manutenzione periodica ..	IT - 39
5.1.b	Controllo livello olio	IT - 43
5.1.c	Sostituzione olio motore e filtro	IT - 43
5.1.d	Controllo livello liquido di raffreddamento	IT - 46
5.1.e	Pulizia filtro aria motore...	IT - 46
5.1.f	Pulizia filtro aria trasmissione	IT - 48
5.1.g	Controllo candela	IT - 49
5.1.h	Controllo pneumatici e relativa pressione	IT - 49
5.1.i	Controllo pneumatici	IT - 50
5.1.l	Controllo usura pastiglie freno	IT - 51
5.1.m	Controllo livello fluido freno anteriore/posteriore	IT - 53
5.1.n	Cambio del liquido freni...	IT - 54
5.1.o	Controllo della cinghia trapezoidale.....	IT - 54

5.1.p	Controllo e lubrificazione del cavalletto centrale e del cavalletto laterale	IT - 55
5.1.q	Registrazione precarico molle ammortizzatori	IT - 55
5.1.r	Regolazione frenatura ammortizzatore anteriore	IT - 56
5.1.s	Controllo piantone anteriore sterzo	IT - 56
5.1.t	Controllo e ricarica della batteria.....	IT - 57
5.1.u	Controllo/sostituzione dei fusibili	IT - 59
5.1.v	Controllo luci	IT - 61
6.1	CURA E RIMESSAGGIO DEL MOTOCICLO.....	IT - 62
6.1.a	Cura	IT - 62
6.1.b	Lavaggio.....	IT - 63
6.1.c	Rimessaggio	IT - 64
6.1.d	Rimessaggio prolungato ..	IT - 65
7.1	DATI TECNICI	IT - 66
8.1	TABELLA PRODOTTI RACCOMANDATI	IT - 69

9.1	LIBRETTO DI GARANZIA E DI SERVIZIO.....	IT - 71
9.1.a	Il contenuto della garanzia	IT - 72
9.1.b	L'attivazione della batteria	IT - 72
9.1.c	Cosa fare in caso di richiesta di intervento in garanzia.....	IT - 72
9.1.d	Condizioni di garanzia.....	IT - 72



1.1 PRESENTAZIONE

Benvenuti nella famiglia motociclistica **Italjet!**

Il vostro scooter **Italjet** è stato progettato e costruito per essere il migliore della sua categoria. Le istruzioni di questo manuale sono state preparate per fornire una guida semplice e chiara all'uso e alla manutenzione del motociclo. Per ottenere da esso le migliori prestazioni, si raccomanda di seguire attentamente quanto riportato su questo manuale. In esso sono racchiuse le istruzioni per effettuare le necessarie operazioni di manutenzione. Le riparazioni o le manutenzioni più specifiche o di maggiore entità richiedono il lavoro di meccanici esperti e l'uso di apposite attrezzature. Si consiglia di rivolgersi alla Rete Ufficiale **Italjet** che dispone di tutti gli strumenti per offrire il miglior servizio al Cliente.

ATTENZIONE

Ricordare infine che il “Manuale di uso e manutenzione” deve considerarsi parte integrante del motociclo e come tale rimanere allegato allo stesso anche in caso di rivendita.

Questo motociclo utilizza componenti progettati e realizzati grazie a sistemi e tecnologie d'avanguardia.

Per il corretto funzionamento del motociclo è necessario attenersi alla tabella di controllo e manutenzione riportata nel presente manuale.



1.2 AVVERTENZE IMPORTANTI

I modelli **DRAGSTER** sono motocicli per impiego STRADALE, coperti da garanzia contrattuale, a condizione che **VENGA MANTENUTA LA CONFIGURAZIONE DI SERIE** e rispettati gli interventi di manutenzione.



1.3 SIMBOLOGIE PRESENTI NEL MANUALE

Le informazioni particolarmente importanti sono evidenziate dalle seguenti simbologie.

 PERICOLO	PERICOLO viene utilizzato per richiamare l'attenzione sui rischi potenziali di infortuni. Osservare tutti i messaggi di sicurezza che seguono questo simbolo per evitare infortuni o il decesso.
 AVVERTENZA	AVVERTENZA indica una situazione pericolosa che, se non evitata, potrebbe provocare il decesso o infortuni gravi.
ATTENZIONE	ATTENZIONE indica speciali precauzioni da prendersi per evitare di danneggiare il veicolo.
NOTA	<i>NOTA</i> contiene informazioni importanti sull'argomento trattato.



1.4 GUIDA SICURA E SICUREZZA DEL MOTOCICLO

Di seguito elenchiamo alcuni principi di base per una guida sicura del vostro scooter.

- Ricordatevi che la Vostra sicurezza e la sicurezza del passeggero vengono prima di tutto. Arrivare sani e salvi alla fine del viaggio deve essere l'obiettivo principale.
- Il pilota e il passeggero devono indossare adeguati indumenti di protezione quali tute, guanti, scarpe, casco omologati per un uso motociclistico.
- La posizione del pilota sulla moto deve essere tale da avere la più ampia visuale possibile della strada che si sta percorrendo.
- Guidare la moto con prudenza, impostare la velocità in funzione al traffico e al tipo di conformazione della strada. Una guida fluida permette di valutare i pericoli e di impostare le traiettorie in curva in modo più preciso.
- Prestare sempre attenzione ai cartelli segnaletici e modulate la velocità in funzione alle indicazioni riportate.
- Rispettate sempre i limiti di velocità.
- Valutate sempre le condizioni del fondo stradale e modulate la velocità

in funzione dello stesso.

- Limitare la velocità in caso di pioggia e soprattutto in caso di presenza di pozzanghere sull'asfalto.
- Quando si procede su superfici bagnate o su superfici con scarsa aderenza (neve, ghiaccio, fango, ecc..) mantenere una velocità moderata evitando frenate brusche e manovre improvvise.
- Mantenere le distanze di sicurezza dai veicoli che Vi precedono.
- Prima di effettuare un sorpasso verificare che non vi siano ostacoli davanti al veicolo che dovete sorpassare e controllate sempre tramite gli specchietti retrovisori che non vi siano altri veicoli che sopraggiungono da dietro.
- Frenare utilizzando contemporaneamente sia il freno anteriore che quello posteriore: ciò contribuisce a mantenere la stabilità del veicolo.
- Se avvertite stanchezza o sonnolenza fermatevi a riposare. L'utilizzo continuo dei freni in discesa potrebbe provocare il surriscaldamento delle pastiglie dei freni limitando l'azione frenante;
- Non spegnere il motore quando si procede in discesa.
- Quando viaggiate con il passeggero aumentate le distanze di sicurezza dai veicoli che Vi precedono e tenete

conto del suo peso quando frenate e quando dovete effettuare una curva od un sorpasso.

- La posizione del conducente e del passeggero sono importanti per il controllo del mezzo.
- Durante la marcia, per mantenere il controllo del motociclo il conducente deve tenere entrambe le mani sul manubrio ed entrambi i piedi sui poggiatesta.
- Il passeggero deve tenersi sempre con entrambe le mani al conducente o alla maniglia, e tenere entrambi i piedi sui relativi poggiatesta. Non trasportare mai un passeggero se non è in grado di posizionare fermamente entrambi i piedi sui relativi poggiatesta.
- Non guidare mai sotto l'influsso di alcool o droghe.
- Questo scooter è progettato esclusivamente per l'utilizzo su strada. Non è adatto per l'utilizzo in fuoristrada.
- Non utilizzate lacci corde ecc... per fissare il bagaglio, utilizzate solo borse omologate adatte per il tipo di moto che utilizzate.
- Il carico massimo trasportabile (pilota, passeggero e bagaglio) non deve superare i 155 kg (342 lb.). In nessun caso il peso del bagaglio deve superare i 5 kg (11 lb.).





1.5 SISTEMA FRENANTE ANTIBLOCCAGGIO - ABS

L'ABS è un sistema elettro-meccanico di ausilio alla frenata:

impedisce il bloccaggio delle ruote in fase di frenata, contribuendo a mantenere la stabilità del veicolo, in presenza di fondo stradale sdruciolevole, bagnato, o sporco.

In condizioni di scarsa aderenza, il sistema può intervenire allungando lo spazio di frenata (ad es. presenza di pietrisco o fondo sdruciolevole), ma garantisce in ogni caso lo spazio minimo per quel particolare fondo stradale.

- Il sistema ABS non entra in funzione a velocità inferiori a 10 km/h. Quando, durante la frenata, entra in funzione il sistema, si avvertono delle pulsazioni sulla leva del freno: questa sensazione non deve indurre ad allentare la pressione sulla leva, in quanto si annullerebbe l'azione del sistema. Peraltro, la presenza del sistema ABS non deve indurre a comportamenti o a condotte di guida che eccedono le consuete norme di prudenza.
- Utilizzare sempre pastiglie e pneumatici consigliati per garantire il corretto funzionamento del sistema ABS.

1.6 RISCHI LEGATI AL MONOSSIDO DI CARBONIO

I gas di scarico contengono monossido di carbonio, un gas incolore ed inodore. Respirare il monossido di carbonio può causare la perdita dei sensi ed il decesso.

Se il motore viene avviato in ambienti completamente o solo in parte chiusi, l'aria che si respira può contenere una pericolosa quantità di monossido di carbonio. Non avviare mai la motocicletta in un garage od in altri luoghi chiusi.

 **PERICOLO**

Il monossido di carbonio è un gas tossico. Respirarlo può causare la perdita dei sensi ed il decesso. Evitare tutte le zone o le attività che possano esporre al monossido di carbonio.



1.7 INFORMAZIONI DI SICUREZZA

1.7.a Accessori

La scelta degli accessori per il vostro veicolo è una decisione importante. Utilizzare solo accessori originali, disponibili presso i concessionari **Italjet** testati ed approvati per l'utilizzo sul vostro veicolo.

L'aggiunta di accessori elettrici va effettuata con cautela. Se gli accessori elettrici superano la capacità dell'impianto elettrico dello scooter, si potrebbe verificare un guasto all'impianto elettrico.

1.7.b Trasporto dello scooter

Prima di trasportare lo scooter su un altro veicolo, attenersi alle seguenti istruzioni.

- Rimuovere dallo scooter tutti gli oggetti non ancorati.
- Orientare la ruota anteriore in posizione di marcia in linea retta sul rimorchio o sul pianale dell'autocarro e bloccarla opportunamente per impedirne lo spostamento.
- Fissare lo scooter con apposite funi o cinghie di ancoraggio in corrispondenza di componenti solidi dello scooter stesso, quali ad esempio il telaio (e non ad esempio agli indicatori di direzione o ad altri componenti che potrebbero rompersi). Scegliere attentamente la posizione di fissaggio delle cinghie per evitare che queste ultime sfreghino contro le parti verniciate durante il trasporto.
- La sospensione, se possibile, deve essere parzialmente compressa, il modo che lo scooter non sobbalzi eccessivamente durante il trasporto.

1.7.c Chiave ripiegabile

La chiave (1) del Dragster è ripiegabile.

Onde evitarne la rottura, si raccomanda di piegare il manico della chiave (1) in maniera perpendicolare alla chiave stessa durante la marcia del veicolo.





2.1 COMPONENTI DELLO SCOOTER

Vista laterale destra

1. Pedane poggipiedi pilota
2. Sella pilota
3. Sella passeggero
4. Maniglie passeggero
5. Pedane poggipiedi passeggero
6. Ammortizzatore posteriore
7. Silenziatore di scarico
8. Vano portaoggetti

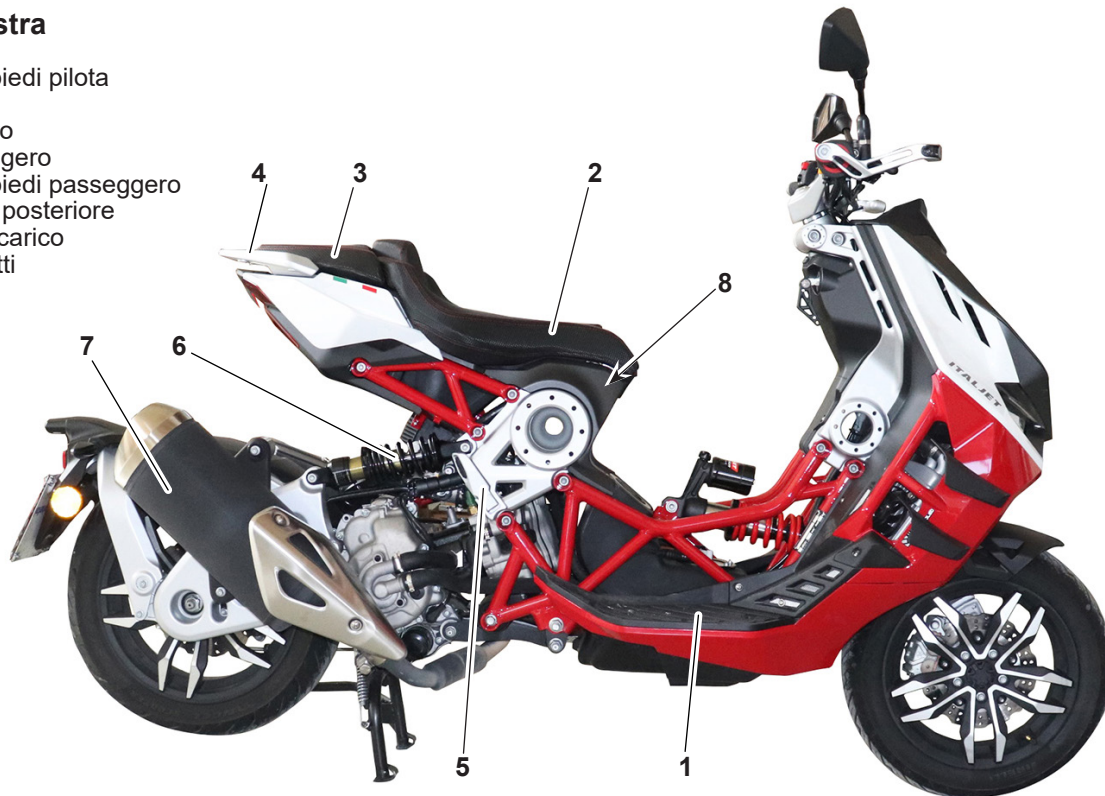



Vista laterale sinistra

1. Ruota anteriore
2. Disco freno anteriore
3. Pinza freno anteriore
4. Monobraccio anteriore
5. Ammortizzatore monobraccio
6. Serratura accesso vano sottosella
7. Regolatore di tensione
8. Motore
9. Filtro aria
10. Cavalletto centrale
11. Filtro aria trasmissione
12. Disco e pinza freno posteriore
13. Ruota posteriore
14. Tappo serbatoio carburante
15. Serbatoio carburante
16. Cavalletto laterale





Vista frontale e posteriore

1. Specchietto retrovisore destro
2. Specchietto retrovisore sinistro
3. Indicatore di direzione destro
4. Indicatore di direzione sinistro
5. Fanale anteriore
6. Radiatore destro
7. Radiatore sinistro
8. Luce posteriore
9. Freccia posteriore sinistra
10. Freccia posteriore destra
11. Luce targa
12. Portatarga

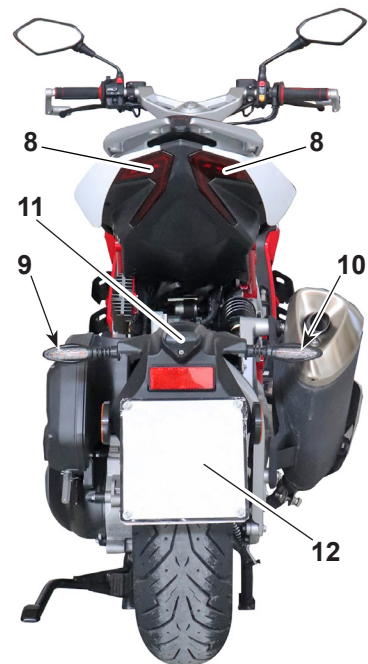



2.2 COMANDI E STRUMENTAZIONE

1. Manopola sinistra
2. Blocchetto comandi sinistro
3. Leva freno posteriore
4. Comando acceleratore
5. Blocchetto comandi destro
6. Leva freno anteriore
7. Blocchetto accensione
8. Presa USB
9. Strumento digitale





2.3 DATI PER L'IDENTIFICAZIONE

Il numero di identificazione del motore è stampigliato sulla parte posteriore/superiore del carter motore, mentre il numero di matricola è stampigliato sul telaio sotto la sella. Riferite sempre, annotandolo anche sul presente libretto, **il numero stampigliato sul telaio** quando ordinate i ricambi o chiedete informazioni sul vostro motociclo.

MATRICOLA MOTORE

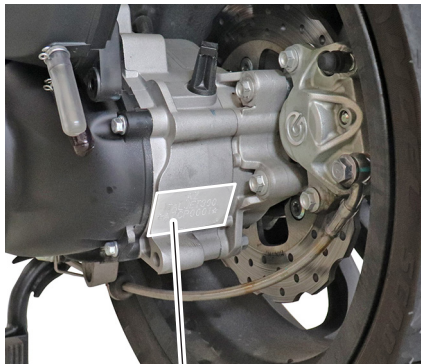

2

MATRICOLA MOTOCICLO



1





2.4 STRUMENTAZIONE

2.4.a Spie di segnalazione e avvertimento

- 1) Spia indicatore di direzione sinistro.
- 2) Spia indicatore di direzione destro.
- 3) Spia insufficiente pressione olio motore.
- 4) Spia luce abbagliante.
- 5) Spia allarme temperatura elevata liquido di raffreddamento.
- 6) Spia riserva carburante.
- 7) Spia ABS.
- 8) Spia anomalia motore.

Spia indicatore di direzione sinistro "←"

La spia lampeggia quando si inserisce l'indicatore di direzione sinistro tramite l'apposita levetta di comando posta sul blocchetto comandi sinistro.

Spia indicatore di direzione destro "→".

La spia lampeggia quando si inserisce l'indicatore di direzione destro tramite l'apposita levetta di comando posta sul blocchetto comandi sinistro.

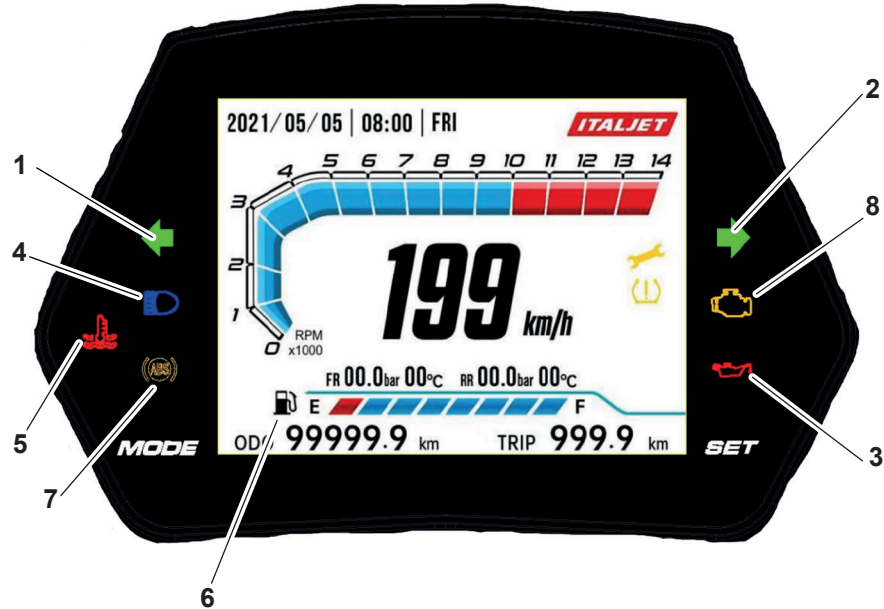

Spia insufficiente pressione olio motore "🛢️".

Si illumina con chiave di avviamento in posizione "ON" e si deve spegnere quando il motore è avviato. Se rimane accesa o si illumina a motore

avviato, arrestare il motore e verificare il livello dell'olio come descritto nel relativo paragrafo o rivolgersi al vostro concessionario di fiducia per il controllo dell'anomalia.





ATTENZIONE

Non utilizzare il motociclo con una insufficiente pressione di olio; possibile rottura del motore.

Spia luce abbagliante “”.

La spia si illumina quando si inserisce la luce abbagliante tramite l'apposito comando posizionato sul blocchetto comandi sinistro.

Spia allarme temperatura elevata liquido di raffreddamento “”.

Si illumina quando la temperatura del liquido di raffreddamento ha raggiunto il valore massimo consentito.

ATTENZIONE

Arrestare il motociclo e spegnere il motore. Non utilizzare il motociclo con la temperatura del liquido di raffreddamento elevata; possibile rottura del motore.

- Attendere che il liquido di raffreddamento si sia raffreddato quindi verificare il livello come descritto nel relativo paragrafo o rivolgersi al vostro concessionario di fiducia per il controllo dell'anomalia.

Spia riserva carburante “”

Se la spia si illumina durante l'uso del motociclo indica che il livello di carburante ha raggiunto il livello di riserva (2 litri), indicando una autonomia limitata di percorrenza; effettuare il rifornimento di carburante il più presto possibile.

Spia ABS “”

Ruotando la chiave, la centralina ABS esegue un'autodiagnosi, la spia si illumina per qualche secondo e poi si spegne indicando assenza di anomalie.

Se invece, la spia si illumina durante il funzionamento del motociclo, indica che vi è un'anomalia al sistema frenante ABS:

- Fermarsi e spegnere il motore ;

- Attendere qualche minuto e riavviare il motore. Se la spia si illumina di nuovo, rivolgersi al più vicino Concessionario **Italjet** per effettuare un controllo sul sistema ABS.

Spia anomalia motore “”

Ruotando la chiave di avviamento la centralina motore esegue un'autodiagnosi, la spia si illumina per qualche secondo e poi si spegne indicando assenza di anomalie.

Se la spia si illumina durante il funzionamento del motore indica che vi è una anomalia al motore o al sistema di iniezione;

- Fermarsi e spegnere il motore ;
- Attendere qualche minuto e riavviare il motore. Se la spia si illumina rivolgersi al più vicino Concessionario **Italjet** per effettuare un controllo sul sistema di autodiagnosi.





2.4.b Strumento digitale

- 1) Indicatore di velocità (Tachimetro) km/h - mi/h.
- 2) Data / ora / giorno.
- 3) Indicatore livello di carburante.
- 4) Indicatore km/mi totali percorsi.
- 5) Indicatore km/mi parziali percorsi.
- 6) Spia manutenzione programmata scaduta.
- 7) Pulsante "MODE".
- 8) Pulsante "SET".

Indicatore velocità (1)

Indica la velocità del motociclo; la velocità può essere indicata in km/h o mi/h in funzione a come è stata impostata l'unità di misura.

Data/Ora/Giorno della settimana (2)

2a) Indica la data; può essere visualizzata con "anno/mese/giorno" oppure con "giorno/mese/anno"

2b) Indica l'ora; può essere impostato con una scala di 24 ore oppure di 12 ore.

2c) Indica il giorno della settimana.

Indicatore livello di carburante (3)

Indica il livello di carburante all'interno del serbatoio; scala (3a) completamente visibile indica il livello massimo, scala (3a) non visibile indica il

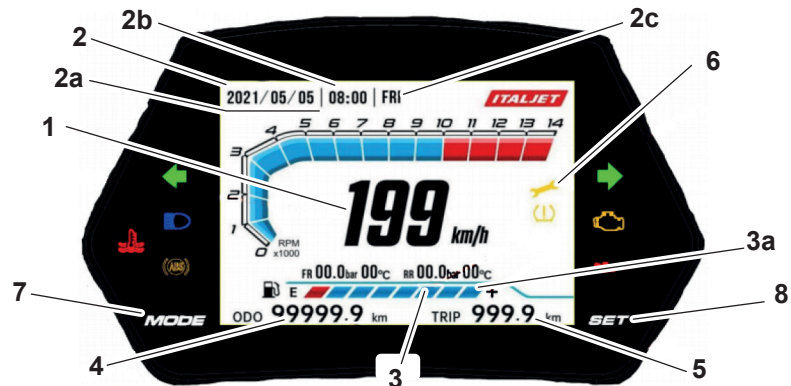

livello minimo, la spia "🛢️" si illumina.

Indicatore km/mi totali percorsi (4)

In questa parte del display è possibile visualizzare i km/mi totali percorsi.

Indicatore Km/mi percorsi parziali (TRIP) (5)

In questa parte del display è possibile visualizzare i km/mi parziali percorsi dall'ultimo azzeramento.

Spia manutenzione programmata scaduta (6)

La spia lampeggia quando mancano 100km / 62mi alla manutenzione.

La spia rimane fissa quando i km/mi dell'intervallo di manutenzione è stato superato e rimane illuminata fissa fino al ripristino.

Dopo aver eseguito la manutenzione, visualizzare TOTAL ODO, quindi premere il pulsante "mode" (7) per più di 10 secondi; la spia manutenzione si spegne.

Pulsante MODE (7)

Il pulsante "mode" permette di scorrere all'interno del software.

Pulsante SET (8)

Il pulsante "set" permette di impostare l'unità di misura e di cancellare i contatori parziali.



2.5 REGOLAZIONE E IMPOSTAZIONE DISPLAY

PERICOLO

Tutte le regolazioni devono essere effettuate con il motociclo fermo.



Impostazione km/mi e orologio 24 ore / 12 ore

- Premere il tasto “**mode**” fino a visualizzare i km/mi totali.
- Premere e mantenere premuto per almeno dieci secondi il tasto “**set**” si passa dall’unità di misura km + orologio 24 ore a mi (miglia) + orologio 12 ore e viceversa; i contatori parziali si azzerano.

Impostazione orario

- Premere contemporaneamente per più di due secondi i tasti “**mode**” e “**set**”, le ore e i minuti iniziano a lampeggiare.
- Premere il tasto “**mode**” per incrementare le ore e il tasto “**Set**” per incrementare i minuti.
- Premere contemporaneamente per più di due secondi i tasti “**mode**” e “**set**” per confermare l’impostazione dell’orario.

Impostazione km/mi e ore parziali “Trip A o Trip B”

- Premere il pulsante “**mode**” fino a visualizzare “Trip A” o “Trip B”, premendo velocemente il tasto “**set**” si passa da visualizzare i km/mi parziali percorsi alle ore parziali per il percorso fatto.
- Per azzerare i km/mi parziali percorsi e il tempo parziale premere per più di due secondi il tasto “**set**”, i valori si azzerano e riparte un nuovo conteggio.



2.6 COMANDI

2.6.a Blocchetto chiave

Il blocchetto chiave consta di tre posizioni:

- ↻ posizione avviamento motociclo (chiave non estraibile);
- ⊗ posizione estrazione chiave;
- “lock” posizione bloccaggio sterzo (chiave estraibile).

- Posizione estrazione chiave “⊗”

Ruotando la chiave in posizione “⊗” il motore e le luci si spengono ed è possibile estrarre la chiave dal blocchetto.

- Posizione avviamento “↻”

Dalla posizione “⊗” (estrazione chiave) ruotare la chiave (1) in senso orario in posizione “↻”; si illumineranno le luci, il display e si potrà avviare il motociclo.





2.6.b Bloccasterzo “lock”

Per bloccare lo sterzo operare nel modo seguente:

- Girare il manubrio completamente a sinistra
- Inserire la chiave (1) sul blocchetto (2) in posizione .
- Premere la chiave (1) e ruotarla in senso antiorario in posizione “**lock**”.
- Estrarre la chiave (2).







Per sbloccare lo sterzo, operare inversamente.





2.7 BLOCCHETTO COMANDI SINISTRO

Il blocchetto sinistro ha i seguenti comandi:

1.  Lampeggio abbagliante.
2.  / 
Commutatore luce anabbagliante/abbagliante.
3.  Interruttore luci di Emergenza.
4.  Avvisatore acustico.
5.  Interruttore indicatori di direzione.

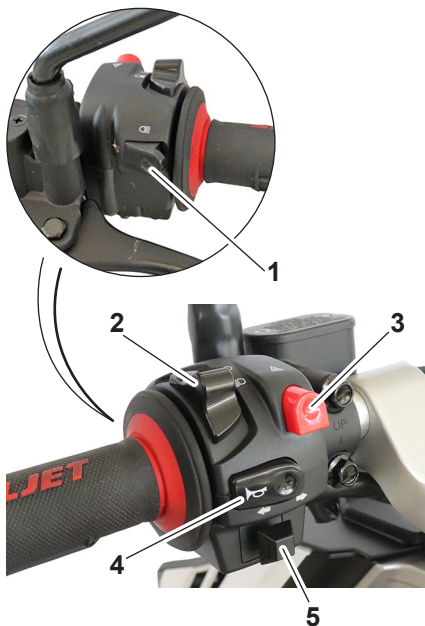

Lampeggio abbagliante “”

Premere il pulsante (1) quando sono inserite le luci anabbaglianti.





Commutatore anabbaglianti/ abbaglianti “ / ”

A seconda del posizionamento del commutatore (2) si illuminano le luci anabbaglianti o le luci abbaglianti:

-  Luci anabbaglianti illuminate.
-  Luci abbaglianti illuminate.

Interruttore luci di Emergenza “”



Premendo l'interruttore (3) lampeggiano contemporaneamente tutti gli indicatori di direzione e sul cruscotto lampeggiano le spie “” e “”.

NOTA: Utilizzare le luci di Emergenza solo in caso di necessità per avvisare gli altri veicoli che il vostro motociclo è fermo. Utilizzando le luci di Emergenza con il motore spento si potrebbe scaricare la batteria.

Avvisatore acustico “”

Premere il pulsante (4) per azionare l'avvisatore acustico.

Interruttore indicatori di direzione “”



Spostando l'interruttore (5) verso “” si inserisce l'indicatore di direzione sinistro, spostando l'interruttore (5) verso “” si inserisce l'indicatore di direzione destro: Una volta rilasciato l'interruttore ritorna in posizione centrale. Per spegnere l'indicatore di direzione inserito premere l'interruttore una volta che è in posizione centrale.





2.8 BLOCCHETTO COMANDI DESTRO

Il blocchetto destro ha i seguenti comandi:

1.  Interruttore Emergenza arresto motore.
2.  Pulsante avviamento motore.



2.8.a Interruttore di EMERGENZA arresto motore



ATTENZIONE

Premere l'interruttore (1) per spegnere il motore solo in caso di reale Emergenza.

Premuto in posizione “” disabilita l'avviamento e il funzionamento del motore.

Premuto in posizione “” abilita il funzionamento del motore e il suo avviamento.

2.8.b Pulsante avviamento motore

Premendo il pulsante (2) con chiave in posizione “” e interruttore (1) in posizione “” premere una leva freno e il motore si avvia.

2.9 COMANDO ACCELERATORE

La manopola (1) dell'acceleratore è situata sul lato destro del manubrio.





2.10 COMANDO FRENO ANTERIORE

La leva (1) del freno è situata sul lato destro del manubrio. Un interruttore di stop, all'atto della frenata, provoca l'accensione della lampada del fanale posteriore. Per azionare il freno tirare la leva verso la manopola acceleratore. La posizione del comando sul manubrio può essere regolata allentando le due viti di fissaggio (2).

⚠ AVVERTENZA

Non dimenticare di stringere le viti (2) dopo la regolazione.

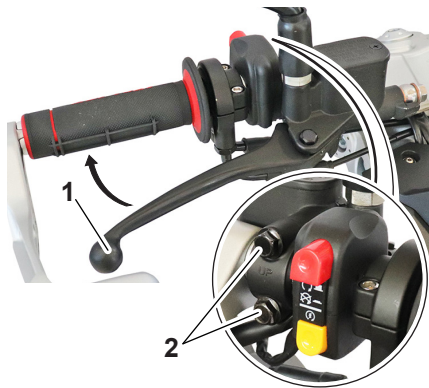

2.11 COMANDO FRENO POSTERIORE

La leva (1) del freno è situata sul lato sinistro del manubrio. Un interruttore di stop, all'atto della frenata, provoca l'accensione della lampada del fanale posteriore. Per azionare il freno tirare la leva verso la manopola. La posizione del comando sul manubrio può essere regolata allentando le due viti di fissaggio (2).

⚠ AVVERTENZA

Non dimenticare di stringere le viti (2) dopo la regolazione.





2.12 SERBATOIO CARBURANTE

PERICOLO

La benzina è estremamente infiammabile e può diventare esplosiva in particolari condizioni. Spegnerne sempre il motore, non fumare o avvicinare fiamme o scintille nell'area dove si effettua il rifornimento o si conserva il carburante.

2.12.a Rifornimento di carburante

- Spegnerne il motore.
- Sollevare il coperchio (1) della serratura.
- Inserire la chiave (2) e ruotarla di 1/4 di giro nel senso della freccia "A" per rimuovere il tappo (3).
- Introdurre il carburante nel serbatoio.

AVVERTENZA

Non riempire il serbatoio oltre il limite inferiore del bocchettone di carico, se il carburante trabocca pulire subito con uno straccio il carburante in quanto oltre ad essere estremamente infiammabile può deteriorare le superfici verniciate o di plastica.

- Rimontare il tappo (3) procedendo inversamente alle operazioni di rimozione, ruotando la chiave nel senso della freccia "B" quindi togliere la chiave (2) e abbassare il coperchio (1) di protezione serratura.

NOTA: Non è possibile rimontare il tappo carburante (3) senza che la chiave sia inserita nella serratura; è possibile rimuovere la chiave (2) dal tappo (3) solo se quest'ultimo è chiuso correttamente.

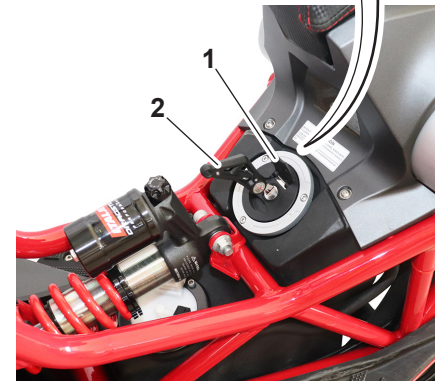
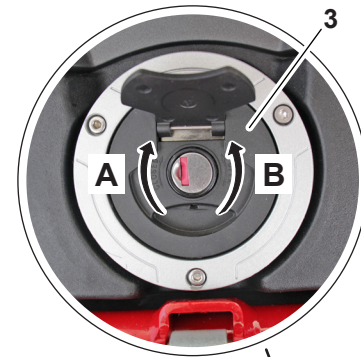



AVVERTENZA

Verificare che il tappo serbatoio carburante sia chiuso correttamente dopo il rifornimento di carburante. Le perdite di carburante costituiscono un rischio d'incendio.

2.13 CARBURANTE

AVVERTENZA

La benzina è velenosa e può provocare infortuni o il decesso. Maneggiare con cautela la benzina. Non aspirare mai la benzina con la bocca. In caso di ingestione di benzina o di inspirazione di grandi quantità di vapori di benzina, o se la benzina viene a contatto con gli occhi, contattare immediatamente un medico.

Se si versa benzina sulla pelle, lavare con acqua e sapone. Se si versa benzina sugli abiti cambiarli.

Il motore è stato progettato per l'utilizzo di benzina senza piombo con un numero di ottano controllato di 95 o più.

Se il motore batte in testa, usare benzina di una marca diversa o con numero di ottano più alto.

Carburante consigliato:

Benzina senza piombo (E10 accettabile)

Numero di ottano (RON):

95

E5

E10

NOTA:

- Questo riferimento identifica il carburante consigliato per questo veicolo come specificato dal regolamento europeo (EN228).
- Verificare che l'ugello della pompa di benzina presenti lo stesso riferimento identificativo carburante.

2.13.a Diversi tipi di benzina

Esistono diversi tipi di benzina contenenti etanolo. Si può utilizzare benzina contenente etanolo se il contenuto di etanolo non supera il 10% (E10). **Italjet** sconsiglia la benzina contenente metanolo in quanto può provocare danneggiamenti all'impianto di alimentazione, oppure problemi alle prestazioni del veicolo.

ATTENZIONE

Usare soltanto benzina senza piombo. L'utilizzo di benzina con piombo provocherebbe danneggiamenti gravi sia alle parti interne del motore, come le valvole ed i segmenti, sia all'impianto di scarico.



2.13.b Convertitore catalitico

L'impianto di scarico comprende convertitori catalitici per ridurre le emissioni di scarico nocive.

AVVERTENZA

L'impianto di scarico raggiunge elevate temperature dopo il funzionamento del motociclo. Per prevenire il rischio di incendi o scottature:

- Non parcheggiare il veicolo vicino a materiali che possono comportare rischi di incendio, come erba o altri materiali facilmente combustibili.
- Parcheggiare il veicolo in un punto in cui non ci sia pericolo che pedoni o bambini tocchino l'impianto di scarico bollente.

- Verificare che l'impianto di scarico si sia raffreddato prima di eseguire lavori di manutenzione su di esso.
- Non fare girare il motore al minimo anche se per pochi minuti. Un minimo prolungato che può provocare accumuli di calore.

2.14 PARTI ACCESSORI E PRESA USB

ATTENZIONE

L'accessorio collegato alla presa USB non dovrebbe venire utilizzato con il motore spento, ed il carico non deve mai superare i 12W (1A), altrimenti il fusibile potrebbe bruciarsi e la batteria scaricarsi.

2.14.a Per utilizzare la presa USB

- Sollevare la protezione (1).
- Collegare l'accessorio alla presa (2).
- Quando la presa non viene utilizzata riposizionare correttamente la protezione.

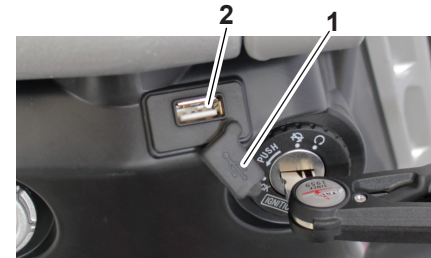



2.14.b Vano sottosella portaoggetti

- Posizionare il motociclo sul cavalletto laterale o sul cavalletto centrale.
 - Inserire la chiave (1) nella serratura (2) e ruotarla fino a sganciare la serratura della sella.
- Sollevare la sella (3) per accedere al vano (4).
 - Per chiudere la sella abbassarla e spingere verso il basso in modo che si agganci alla serratura.

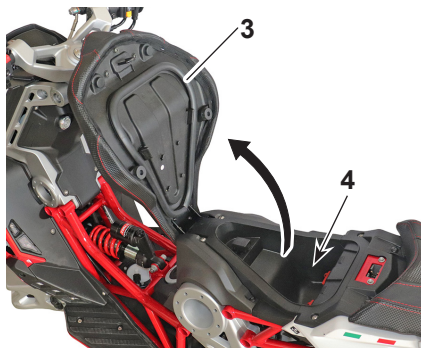
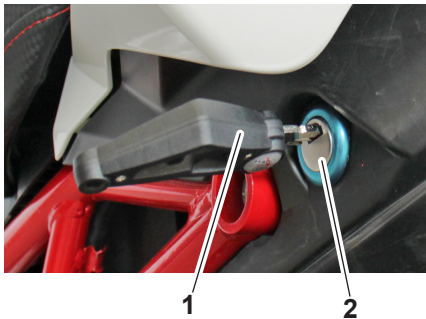

NOTA: Dopo l'apertura del vano sottosella è possibile rimuovere la chiave dalla serratura.





2.14.c Cavalletto laterale

ATTENZIONE

Il cavalletto è progettato per supportare il **SOLO PESO DEL MOTOCICLO**. Non sedersi sul veicolo utilizzando il cavalletto come supporto; potrebbero verificarsi delle rotture con conseguenti gravi lesioni personali.

ATTENZIONE

Il motociclo **DEVE** essere posto sul cavalletto laterale **SOLO DOPO** che il pilota è sceso dal veicolo.

ATTENZIONE

Sul motociclo è posizionato un sensore di sicurezza che non permette l'avviamento della moto, con cavalletto abbassato. Abbassando il cavalletto con motociclo acceso il motore si spegne.

Il cavalletto laterale si trova sul lato sinistro del telaio. Alzare o abbassare il cavalletto (1) con il piede mentre si tiene il veicolo in posizione dritta.

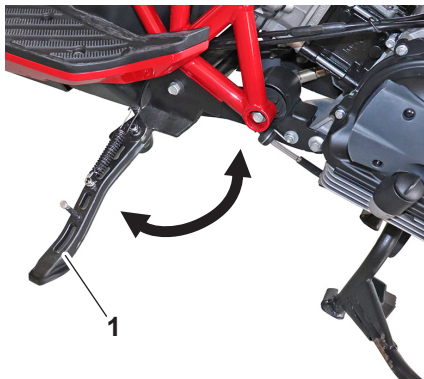

! PERICOLO

Non utilizzare il motociclo con il cavalletto laterale abbassato.

Se il cavalletto laterale non rimane alzato è necessario rivolgersi al concessionario *Italjet* più vicino per la riparazione.

Controllare periodicamente il corretto funzionamento del cavalletto laterale e il corretto funzionamento del sensore di sicurezza che blocca l'avviamento del motociclo con cavalletto abbassato.



2.14.d Cavalletto centrale

- Afferrare la manopola sinistra (1) del manubrio e la maniglia sinistra (2) del passeggero.
- Premere con il piede destro la leva (3) del cavalletto centrale (4) e contemporaneamente sollevare il motociclo verso l'alto ed all'indietro fino ad eseguirne il completo sollevamento sul cavalletto centrale.

ATTENZIONE

Quando il veicolo è in sosta sul cavalletto centrale, è pericoloso sedere a bordo gravando perciò col proprio peso sul supporto di stazionamento.

Per effettuare la discesa del motociclo dal cavalletto centrale, operare come di seguito descritto.

- Afferrare la manopola sinistra (1) e la maniglia sinistra (2) del passeggero.
- Posizionare il piede davanti al cavalletto e spingere il motociclo verso la parte anteriore fino a farlo scendere dal cavalletto; il cavalletto si solleverà automaticamente.





3.1 CONTROLLI PRIMA DELL'UTILIZZO

Ispezionare il veicolo ogni volta che lo si usa per accertarsi che sia in condizione di funzionare in sicurezza. Osservare sempre le procedure e gli intervalli di controllo e manutenzione descritti nel libretto uso e manutenzione.

AVVERTENZA

La mancata esecuzione di un controllo o manutenzione corretta del veicolo aumenta la possibilità di incidenti o di danneggiamenti del mezzo. Non utilizzare il veicolo se si riscontrano problemi. Se non si riesce ad eliminare il malfunzionamento con le indicazioni fornite in questo manuale, fare ispezionare il veicolo da un concessionario *Italjet*.

Prima di utilizzare questo veicolo, controlla i seguenti punti:

ELEMENTO	CONTROLLI
Carburante	<ul style="list-style-type: none">- Controllare il livello carburante nel serbatoio carburante.- Fare rifornimento se necessario.- Controllare l'assenza di perdite nel circuito del carburante.
Olio motore	<ul style="list-style-type: none">- Controllare il livello dell'olio nel motore.- Se necessario, aggiungere olio del tipo consigliato fino al livello.- Controllare l'assenza di perdite di olio dal motore.
Olio della trasmissione finale	<ul style="list-style-type: none">- Controllare l'assenza di perdite di olio dalla trasmissione.
Liquido refrigerante	<ul style="list-style-type: none">- Controllare il livello del liquido refrigerante nel serbatoio di espansione.- Se necessario, rabboccare il liquido refrigerante.- Verificare che non ci siano perdite nel sistema di raffreddamento.
Ruote e pneumatici	<ul style="list-style-type: none">- Controllare l'assenza di danneggiamenti.- Controllare la condizione dei pneumatici e la profondità del battistrada.- Controllare la pressione dell'aria.



ELEMENTO	CONTROLLI
<i>Freni</i>	<ul style="list-style-type: none">- Controllare il funzionamento dei freni.- Se si ha una sensazione di morbidezza e cedevolezza, fare controllare l'impianto di sicurezza a un concessionario Italjet.- Controllare l'usura pastiglie freni.- Sostituirle se necessario, (per la sostituzione rivolgersi a un concessionario Italjet).- Controllare il livello del liquido nel serbatoio, se necessario rabboccare (per il rabbocco rivolgersi a un concessionario Italjet).- Verificare che non ci siano perdite nell'impianto idraulico.
<i>Cavalletto laterale, cavalletto centrale</i>	<ul style="list-style-type: none">- Accertarsi che il movimento sia agevole.- Lubrificare i punti di rotazione se necessario.
<i>Strumenti, luci, segnali e interruttori</i>	<ul style="list-style-type: none">- Controllare il funzionamento delle luci, degli indicatori di direzione.
<i>Interruttore cavalletto laterale</i>	<ul style="list-style-type: none">- Controllare il funzionamento del sistema d'interruzione circuito accensione.- Se il sistema non funziona correttamente, fare controllare il veicolo da un concessionario Italjet.





3.2 ISTRUZIONI PER L'USO DEL MOTOCICLO

NOTA: Se non avete confidenza col funzionamento del motociclo, prima di guidarlo, leggete attentamente le istruzioni contenute nel paragrafo "COMANDI".

3.2.a Istruzioni per il rodaggio

Durante i primi 1000 km, dovranno essere **SCRUPolosAMENTE** osservate le seguenti norme la cui **INOSSERVANZA POTRÀ PREGIUDICARE LA DURATA E LE PRESTAZIONI DEL MOTOCICLO:**

- Prima di usare il veicolo riscaldare il motore ad un basso numero di giri;
- Evitare le partenze veloci e non far girare il motore ad alti regimi;
- Guidare a velocità moderata sino a quando il motore si sarà riscaldato;
- Usare ripetutamente entrambi i freni per rodare le pastiglie ed i dischi;
- Evitare di mantenere a lungo la stessa velocità;
- Evitare di percorrere lunghi tragitti senza effettuare soste.

3.2.b Individuazione degli inconvenienti di funzionamento

Il seguente elenco di eventuali inconvenienti di funzionamento serve, in linea generale, per individuarne l'origine ed attuarne il rimedio.

Il motore non si avvia

- Inadeguata tecnica d'avviamento: attenersi a quanto riportato al paragrafo "Avviamento del motore";
- Cavalletto laterale abbassato.

Il motore stenta ad avviarsi

- Candela sporca o in cattive condizioni: sostituire

Il motore parte ma il funzionamento è irregolare

- Candela sporca o in cattive condizioni: sostituire;

La candela si sporca facilmente

- Candela non adeguata, sostituire

Il motore è carente di potenza

- Filtro aria sporco: pulire;

I freni non funzionano adeguatamente

- Pastiglie consumate: sostituire presso riparatore specializzato.

ATTENZIONE

Per tutti gli altri inconvenienti rivolgersi a un concessionario *Italjet*.



3.3 SALITA/DISCESA PILOTA E PASSEG- GERO

3.3.a Norme generali

Leggere attentamente le indicazioni di seguito in quanto forniscono informazioni importanti al fine della sicurezza del pilota e del passeggero per evitare danni a persone o al motociclo.

La salita e la discesa dal motociclo deve essere effettuata sempre dalla parte sinistra del motociclo, con le mani libere, senza impedimenti e con cavalletto centrale sollevato.

Se è presente il cavalletto laterale la salita del pilota può essere effettuata con il cavalletto abbassato.

Il pilota deve essere il primo a salire e l'ultimo a scendere dal motociclo e deve governare stabilità del motociclo durante la salita e la discesa del passeggero.

Non scendere dal veicolo saltando o allungando la gamba, scendete sempre eseguendo le operazioni descritte nel relativo paragrafo.

3.3.b Salita del pilota

Sollevare il cavalletto centrale.
Se presente il cavalletto laterale lasciarlo in posizione abbassata.

- Dalla parte sinistra impugnare correttamente con entrambe le mani il manubrio quindi sollevare la gamba destra e oltrepassare la sella.
- Sedersi sulla moto e appoggiare entrambi i piedi a terra raddrizzando il veicolo senza caricare il proprio peso sul cavalletto laterale (se presente).

AVVERTENZA

Nel caso non si riesca ad appoggiare entrambi i piedi a terra, appoggiare il piede destro tenendo il sinistro pronto all'appoggio.

- Con il piede sinistro fare rientrare completamente il cavalletto laterale (se presente);
- Avviare la moto come descritto nel relativo paragrafo.

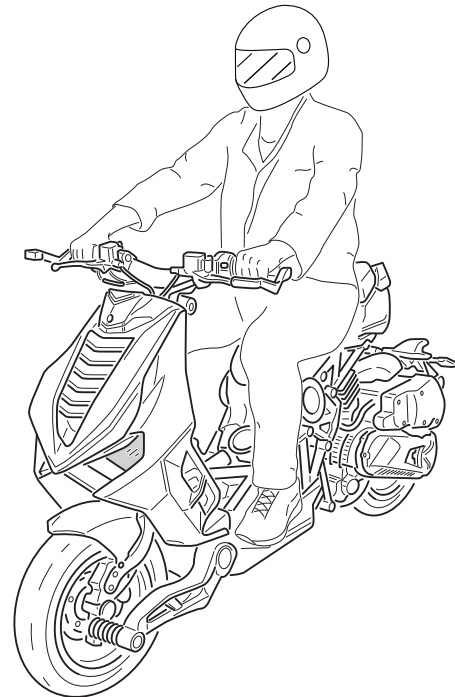



3.3.c Salita del passeggero

- Il pilota deve salire sulla motocicletta come descritto nel relativo paragrafo, senza avviare la motocicletta.
- Il passeggero deve estrarre le pedane poggiapiedi (1).

AVVERTENZA

Il pilota nella posizione di guida non deve assolutamente estrarre o tentare di estrarre i poggiapiedi posteriori del passeggero, potrebbe compromettere l'equilibrio del veicolo.

- Salire sulla moto sollevando la gamba destra muovendosi con cautela per non sbilanciare il veicolo e il pilota.

- Con le mani tenersi alle apposite maniglie (2).
- Con il piede sinistro fare rientrare completamente il cavalletto laterale (se presente).
- Avviare la moto come descritto nel relativo paragrafo.

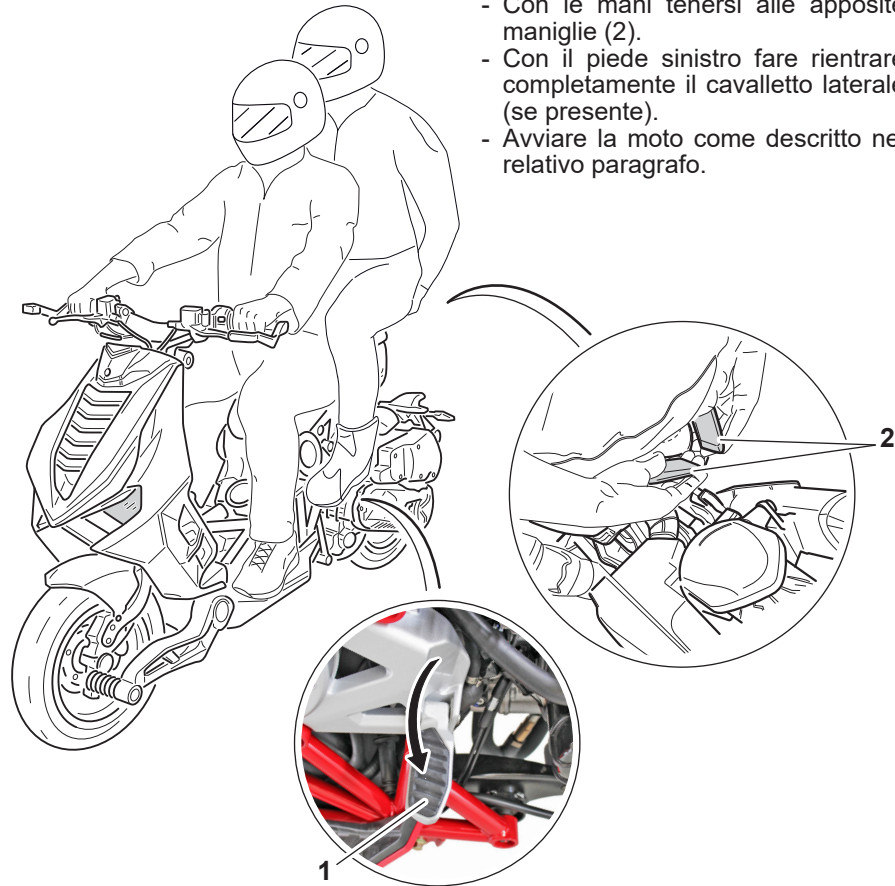



3.3.d Discesa della moto

- Arrestare il veicolo e spegnere il motore.

AVVERTENZA

Accertarsi che la zona dove si deve parcheggiare il veicolo sia stabile e in piano.

- Appoggiare entrambe i piedi a terra.
- Spegnerla la moto come descritto nel relativo paragrafo.
- Con il piede sinistro estrarre completamente il cavalletto laterale (se presente).
- Il passeggero deve scendere per primo dalla parte sinistra del veicolo sollevando la gamba destra.
- Inclinare la moto verso sinistra fino ad appoggiarla sul cavalletto laterale, se presente.
- Con le mani ben salde sul manubrio scendere dalla moto dalla parte sinistra sollevando la gamba destra.

3.4 REGOLAZIONE SPECCHIETTI RETROVISORI

Sedersi sulla moto come descritto nel relativo paragrafo.

Regolare entrambi gli specchietti (1) muovendo direttamente gli stessi in modo che dalla posizione seduta il pilota veda correttamente la parte posteriore della strada.









4.1 AVVIAMENTO DEL MOTOCICLO

Dopo essere saliti sul motociclo, come indicato nel relativo paragrafo, per avviare il motore agire come segue:

NOTA: Il motociclo non si avvia se il cavalletto laterale è abbassato.

- Porre la chiave (1) dell'interruttore accensione in posizione "  ".



- La spia "  ", si illumina per qualche secondo e poi si spegne mentre le spie "  ", "  " rimangono illuminate fino all'avviamento del motociclo.

- Accertarsi che la manopola dell'acceleratore (2) sia completamente rilasciata e che il cavalletto laterale sia in posizione di marcia.
- Tirare una delle due leve del freno.
- Premere il pulsante (3) di avviamento motore e rilasciarlo appena il motore si è avviato.

NOTA: La spia "ABS" rimane accesa fino a che il motoveicolo raggiunge la velocità di 10 km/h (6mi/h) poi si spegne.

NOTA: Non far funzionare il motore freddo ad un elevato numero di giri onde permettere il riscaldamento dell'olio e la sua circolazione in tutti i punti che necessitano di lubrificazione.





4.1.a Uso dell'acceleratore

- Rilasciare la leva del freno tirata e contemporaneamente ruotare la manopola (1) dell'acceleratore; la velocità è direttamente proporzionata con la rotazione della manopola acceleratore, ruotando la manopola verso "A" il motociclo accelera, ruotando la manopola verso "D" il motociclo decelera.

4.1.b Uso dei freni

Per avere un'azione frenante più incisiva si consiglia di azionare contemporaneamente entrambe i freni.

- Rilasciare la manopola acceleratore (1) e tirare entrambe le leve (2) dei freni aumentando gradualmente la pressione in funzione al grado di frenatura desiderato.

AVVERTENZA

Evitare di effettuare frenate brusche, fare molta attenzione a frenare con il motociclo inclinato pericolo di caduta. In alcune condizioni può essere utile l'uso indipendente del freno anteriore o di quello posteriore. Usare il freno anteriore con prudenza, specialmente su terreni sdruciolevoli. L'uso scorretto dei freni può causare gravi incidenti.





4.1.c Arresto del motociclo e del motore

- Rilasciare completamente la manopola (1) dell'acceleratore in modo da far decelerare il motociclo.
- Frenare sia anteriormente che posteriormente.
- Una volta arrestato il motociclo ruotare la chiave di avviamento (2) in posizione "⊗" (posizione di estrazione chiave), il motore si spegne.



4.1.d Arresto del motore in emergenza

- Per arrestare il motore in caso di Emergenza premere l'interruttore rosso (1) su "⊗"; dopo aver fermato il motociclo riportare l'interruttore (1) nuovamente nella posizione "↻".

AVVERTENZA

In caso di bloccaggio dell'acceleratore in posizione aperta o di altro malfunzionamento che facesse girare il motore in modo incontrollabile, premere **IMMEDIATAMENTE** il pulsante (1) arresto motore. Mantenere il controllo del motociclo con il normale uso dei freni e dello sterzo mentre si preme il pulsante di arresto.



4.1.e Parcheggio del motociclo

Posizionare il motociclo sul cavalletto laterale o sul cavalletto centrale come descritto nei relativi paragrafi.

AVVERTENZA

- Dopo lo spegnimento del motociclo, il motore e l'impianto di scarico possono diventare molto caldi, cercare di parcheggiare in modo che i pedoni non tocchino accidentalmente su tali parti.
- Non parcheggiare accanto a erba secca o altri materiali infiammabili che possano prendere fuoco.
- Non parcheggiare su pendenze o su terreno morbido; il motociclo potrebbe ribaltarsi con possibili perdite di benzina e pericolo di incendio.



5.1 MANUTENZIONE E CONTROLLI PERIODICI

5.1.a Manutenzione periodica

Le ispezioni, le regolazioni e le lubrificazioni periodiche conservano il motociclo nelle migliori condizioni possibili di sicurezza e di efficienza. I punti più importanti relativi ai controlli, alle regolazioni ed alla lubrificazione del motociclo sono illustrati nelle pagine seguenti.

Gli intervalli di manutenzione indicati nella tabella vanno considerati solo come una guida generale in condizioni di marcia normali. Tuttavia, potrebbe essere necessario ridurre gli intervalli di manutenzione in funzione delle condizioni climatiche, del terreno, della posizione geografica e dell'impiego individuale.

AVVERTENZA

La mancanza di manutenzione o una manutenzione non corretta del motociclo può aumentare il rischio di infortuni o decessi durante l'uso del veicolo. Far eseguire la manutenzione presso un concessionario *Italjet* o riparatore professionale.

AVVERTENZA

Prima di effettuare qualsiasi operazione di manutenzione verificare di essere in possesso dei necessari strumenti componenti e capacità tecniche.

- Spegnerne il motore e parcheggiare la moto su una superficie piana e solida.
- Attendere che il motore, il silenziatore e i dischi freno si raffreddino.

AVVERTENZA

Se si utilizza il veicolo su strade polverose, fangose o molto bagnate è necessario pulire/sostituire il filtro dell'aria con un intervallo di manutenzione più corto. Recarsi presso il Concessionario *Italjet* per il corretto intervallo di manutenzione.



Intervallo di manutenzione	<i>Tempo o chilometraggio</i>											
	Tempo (Mesi)	6	12	18	24	30	36	42	48	54	60	66
Voci	Chilometraggio (km x 1000)	1	6	12	18	24	30	36	42	48	54	60
Motore												
Rullo puleggia guidata			L		L		L		L		L	
Boccola di plastica copertura variatore			R		R		R		R		R	
Campana frizione		C	C	C	C	C	C	C	C	C	C	C
Cinghia di azionamento			R		R		R		R		R	
Filtro aria trasmissione			I		I		I		I		I	
Pre-filtro a rete olio motore	C	C	C	C	C	C	C	C	C	C	C	C
Filtro olio motore	R	R	R	R	R	R	R	R	R	R	R	R
Gioco valvole			A		A		A		A		A	
Olio mozzo	R		R		R		R		R		R	
Olio motore (*)	R	R	R	R	R	R	R	R	R	R	R	R
Rulli CVT			R		R		R		R		R	
Sempuleggia mobile frontale variatore			I		I		I		I		I	
Trasmissione			L		L		L		L		L	
Candela			R		R		R		R		R	
Filtro aria		C	C	C	C	C	C	C	C	C	C	C



Intervallo di manutenzione	<i>Tempo o chilometraggio</i>											
	Tempo (Mesi)	6	12	18	24	30	36	42	48	54	60	66
Voci	Chilometraggio (km x 1000)	1	6	12	18	24	30	36	42	48	54	60
Sistema di vaporizzazione												
Contenitore e tubi	I		I		I		I		I		I	
Sistema di raffreddamento												
Livello del refrigerante (**)	I	I	I	I	I	I	I	I	I	I	I	I
Radiatore			C		C		C		C		C	
Impianto di alimentazione												
Filtro del carburante			R		R		R		R		R	
Tubi del carburante (***)	I		I		I		I		I		I	
Impianto elettrico												
Tensione batteria	I		I		I		I		I		I	
Regolazione fari			A		A		A		A		A	
Prova su strada del veicolo												
Prova su strada del veicolo	I		I		I		I		I		I	



Intervallo di manutenzione	<i>Tempo o chilometraggio</i>											
	Tempo (Mesi)	6	12	18	24	30	36	42	48	54	60	66
Voci	Chilometraggio (km x 1000)	1	6	12	18	24	30	36	42	48	54	60
Telaio												
Fissaggi di sicurezza		I		I		I		I		I		I
Freni		I	I	I	I	I	I	I	I	I	I	I
Fluidi freni (**)		I		I		I		I		I		I
Sospensioni				I		I		I		I		I
Ruote / pneumatici		I	I	I	I	I	I	I	I	I	I	I
Sterzo		I		I		I		I		I		I
Impianto di scarico				I		I		I		I		I
Controllo acceleratore		A		A		A		A		A		A

I: Controllare e pulire, regolare, lubrificare o sostituire se necessario

C: Pulire

R: Sostituire

A: Regolare

L: Lubrificare

(*) Controllare il livello ogni 3000 km

(**) Sostituire ogni 2 anni

(***) Sostituire ogni 4 anni





5.1.b Controllo livello olio

NOTA: Il controllo deve essere effettuato con motore appena spento e ancora caldo.

⚠ AVVERTENZA

La marmitta del motociclo raggiunge temperature elevate fare attenzione a non scottarsi.

- Posizionare il motociclo in piano, in posizione verticale sollevato sul cavalletto centrale.
- Attendere qualche minuto per consentire all'olio di depositarsi.
- Svitare l'astina di livello (1) e rimuoverla, pulire l'astina con uno straccio e reinserirla nel foro (2) di riempimento senza avvitare, quindi rimuoverla e controllare che il livello dell'olio sia tra i riferimenti del livello minimo "MIN" e massimo "MAX".
- In caso di rabbocco inserire olio tramite il foro (2) fino al livello MAX e non oltre.
- Rimontare l'astina (1) di livello avvitandola.

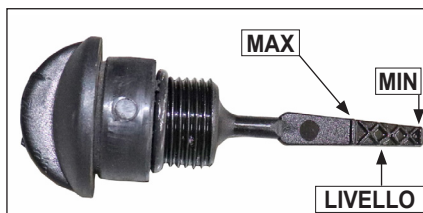

5.1.c Sostituzione olio motore e filtro

NOTA: La sostituzione dell'olio deve essere effettuata con motore appena spento e ancora caldo.

⚠ AVVERTENZA

Fare attenzione a non scottarsi con l'olio caldo.

- Posizionare il motociclo in piano, in posizione verticale sollevato sul cavalletto centrale.
- Rimuovere l'astina di livello olio (1).

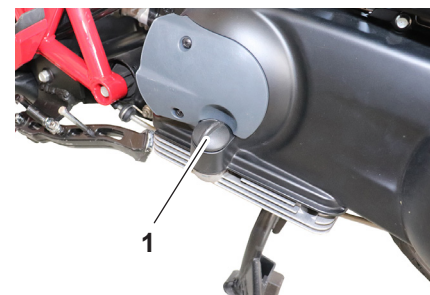



- Porre una bacinella in corrispondenza del tappo di scarico (2).
- Svitare il tappo di scarico (2) e lasciare scaricare tutto l'olio.

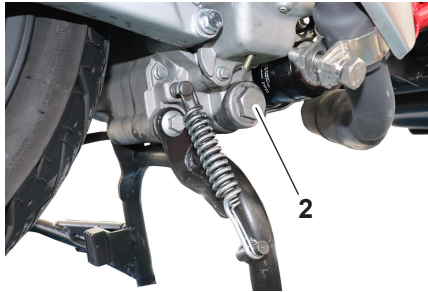

- Tramite l'apposito attrezzo (4) svitare il filtro olio (5).

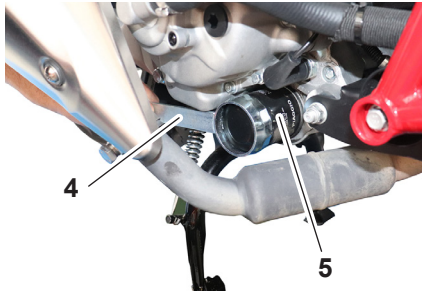

- Pulire il filtro (3), se rovinato sostituire, quindi rimontarlo.

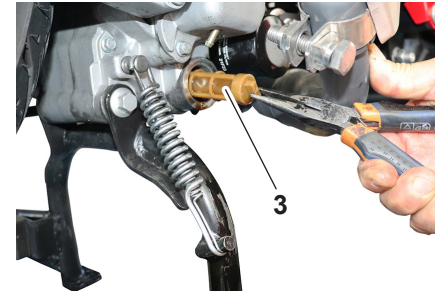

- Tramite una pinza rimuovere il filtro (3) lavabile.

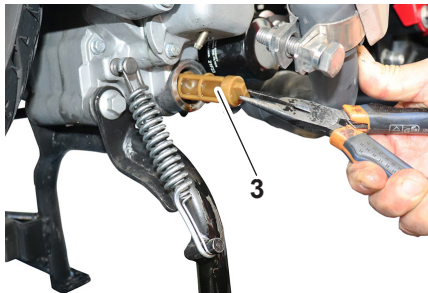

- Rimuovere il filtro (5).

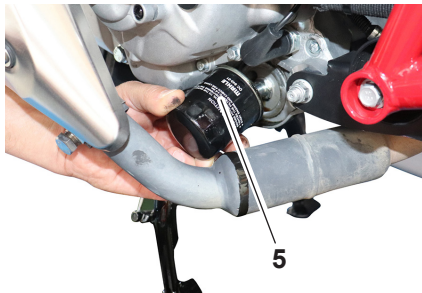

- Verificare lo stato della guarnizione (6) del tappo (2), se rovinata sostituire.

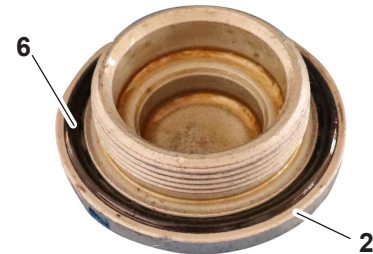



- Rimontare il tappo (2) avvitandolo con una coppia di 25 Nm / 18,44 ft/lb.

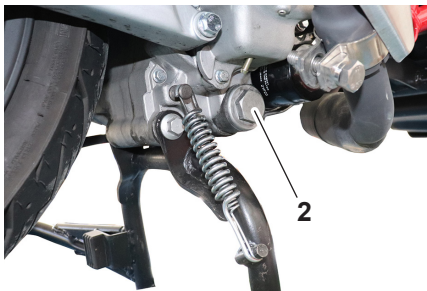

- Montare il filtro (5) avvitandolo con l'apposito attrezzo (4) con una coppia di serraggio di 12 Nm / 8,85 ft/lb.

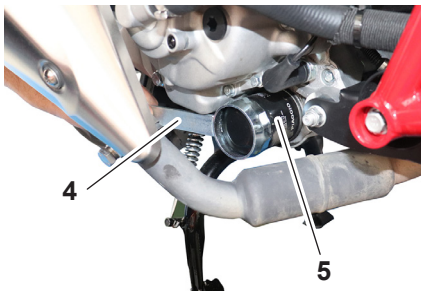

- Rimontare l'astina (1) di livello avvitandola.



NOTA: Per il tipo di olio da utilizzare vedi paragrafo "Rifornimenti".

NOTA: Pulire con uno straccio l'olio eventualmente versato sulle parti dopo che il motore e l'impianto di scarico si sono raffreddati.

- Lubrificare con olio la guarnizione (7).



- Versare circa 1250 cm³ di olio nel serbatoio olio tramite il foro (8).

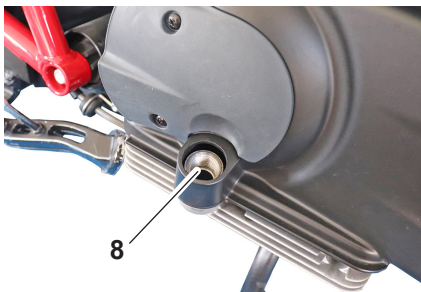

- Accendere il motore e lasciarlo girare al minimo per diversi minuti verificando che non ci siano perdite di olio. In caso di perdite di olio, spegnere immediatamente il motore e cercarne le cause.
- Spegner il motore, controllare il livello dell'olio e correggerlo, se necessario.
- Azzerare l'intervallo di manutenzione come descritto nel paragrafo "Strumento digitale".



5.1.d Controllo livello liquido di raffreddamento

NOTA: Controllare il livello del liquido di raffreddamento con motore freddo.

- Posizionare il motociciclo in piano, in posizione verticale sollevato sul cavalletto centrale.
- Rimuovere il coperchietto (1) del serbatoio (2) di espansione.



- Verificare che il livello del liquido sia compreso tra il livello minimo "MIN" e il livello massimo "MAX" del serbatoio.

- Nel caso sia necessario rabboccare, rimuovere il tappo serbatoio (3) svitandolo e introdurre il liquido di raffreddamento dal foro (4) verificando il livello sul serbatoio (2).
- Ripristinato il livello, rimontare il tappo (3) e il coperchietto (1).

NOTA: Il liquido di raffreddamento è corrosivo, se durante il rabbocco ne viene versato un po', pulire accuratamente le parti che sono state a contatto con acqua.

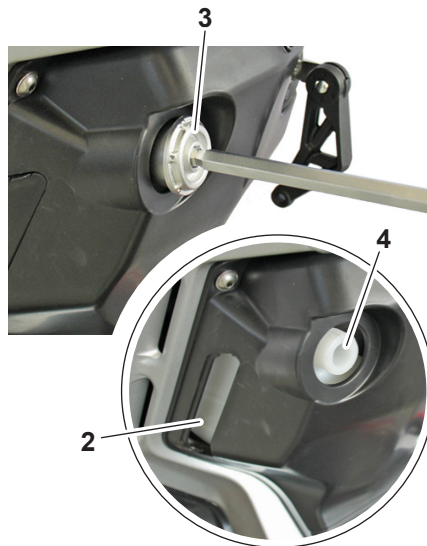

5.1.e Pulizia filtro aria motore

- Svitare le viti (1) e rimuovere il coperchio (2).

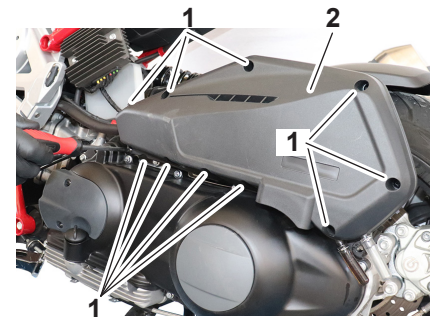

- Rimuovere il filtro (3) dal coperchio filtro (2).

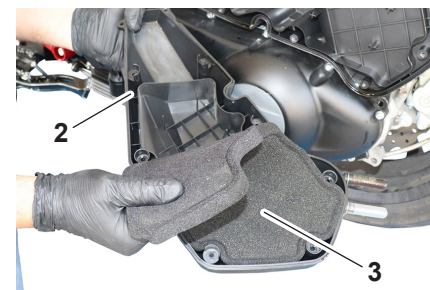



- Pulire il filtro (3) con apposito detergente per filtri e lasciarlo asciugare completamente.

⚠ AVVERTENZA

Per la pulizia del filtro non utilizzare benzina o altri solventi infiammabili.

- Verificare che il filtro non sia usurato o danneggiato, se necessario sostituirlo.
- Applicare olio specifico per filtri su tutta la superficie del filtro (3) quindi strizzarlo per eliminare l'olio in eccesso.
- Rimontare il filtro (3) sul coperchio (2).

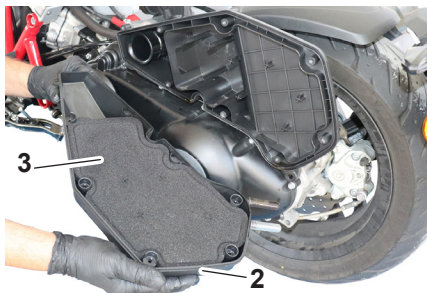

- Verificare lo stato della guarnizione (4), se rovinata sostituire.

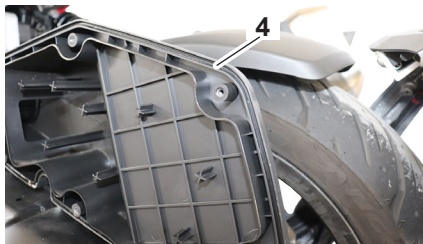

- Rimontare il coperchio filtro (2) avvitando le viti (1).

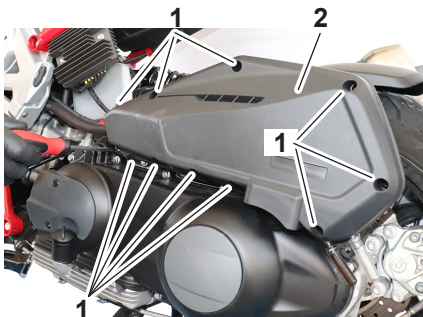

- Verificare che gli sfiati (5) e (6) non siano sporchi, se si intravede dello sporco, rimuovere gli sfiati, pulirli, quindi rimontarli.

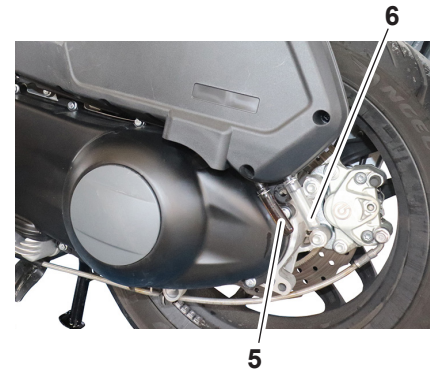



5.1.f Pulizia filtro aria trasmissione

- Svitare le viti (1) e rimuovere il coperchio (2).

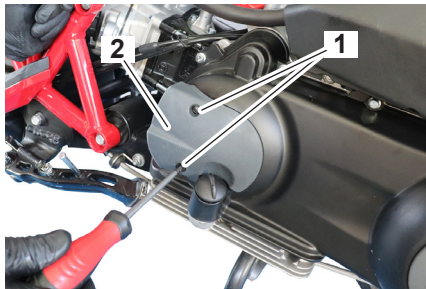

- Rimuovere il filtro (3) e pulirlo con appositi detergenti.

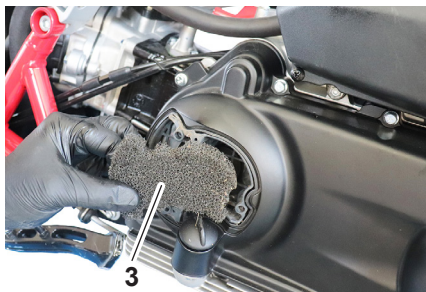

AVVERTENZA

Per la pulizia del filtro non utilizzare benzina o altri solventi infiammabili.

- Verificare che il filtro non sia usurato o danneggiato, se necessario sostituirlo.
- Verificare lo stato della guarnizione (4), se rovinata, sostituire.

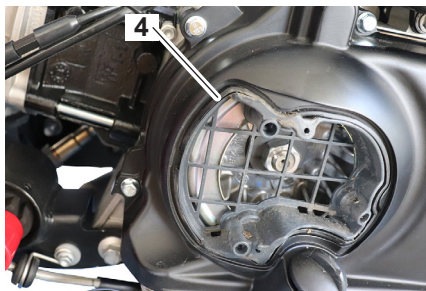

- Rimontare il filtro (3) ed il coperchio (2) procedendo in senso inverso allo smontaggio.

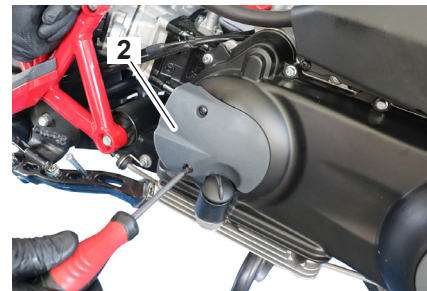



5.1.g Controllo candela

⚠ AVVERTENZA

Attendere che il motore si sia raffreddato prima di eseguire il controllo; pericolo di ustione.

- Togliere il cappuccio (1).
- Tramite l'apposita chiave rimuovere la candela (2).

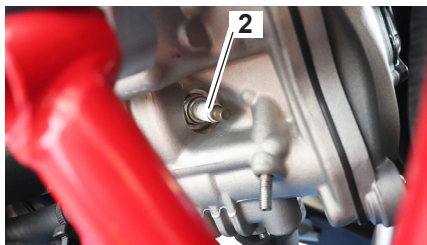

La distanza fra gli elettrodi della candela (2) deve essere $0,5 \div 0,6$ mm. Una distanza differente può causare malfunzionamento al motociclo.

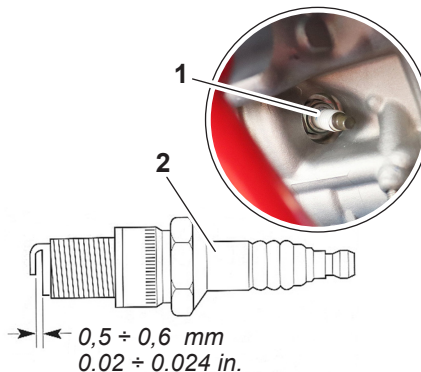

5.1.h Controllo pneumatici e relativa pressione

È fondamentale mantenere sempre i pneumatici in buone condizioni e sostituirli agli intervalli adeguati con pneumatici secondo specifica. Controllare sempre e, se necessario, regolare la pressione pneumatici prima di mettersi in marcia.

⚠ AVVERTENZA

L'utilizzo del motociclo con una delle pressioni pneumatiche scorrette può provocare infortuni gravi o il decesso a seguito della perdita del controllo.

- Controllare e regolare la pressione dei pneumatici a freddo (ossia quando la temperatura dei pneumatici è uguale alla temperatura ambiente).
- Si deve regolare la pressione dei pneumatici in funzione del peso totale del pilota, del passeggero, del carico e degli accessori omologati per questo modello.



5.1.i Controllo pneumatici

Questo motociclo è dotato di pneumatici senza camera d'aria.

- Controllare lo stato degli pneumatici, non devono avere fessurazioni, abrasioni ecc., inoltre controllare lo stato di usura del battistrada tramite gli appositi indicatori presenti sul pneumatico stesso.

ALTEZZA MINIMA DEL BATTISTRADA

ANTERIORE	2 mm (0.08 in)
POSTERIORE	2 mm (0.08 in)

- Controllare la pressione secondo le indicazioni riportate nel paragrafo dati tecnici.

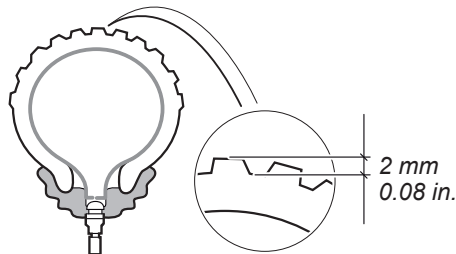

AVVERTENZA

Il pneumatico anteriore e posteriore devono essere della stessa marca e modello, utilizzare differenti tipi di pneumatici tra ruota anteriore e ruota posteriore compromettono la stabilità del motociclo e la sua manovrabilità.

NOTA: I pneumatici invecchiano anche se visivamente non sono usurati; screpolature laterali o deformazioni della carcassa sono un segno di invecchiamento. Fare controllare da un gommista i pneumatici prima di usare il motoveicolo.

Pressione pneumatico a freddo:

1 persona:

Anteriore:
190 kPa (1.9 Kgf/cm², 28 psi)

Posteriore:
200 kPa (2.00 kgf/cm², 29 psi)

2 persone:

Anteriore:
210 kPa (2.10 kgf/cm², 30 psi)

Posteriore:
250 kPa (2.50 kgf/cm², 36 psi)

- Per regolare la pressione rimuovere il cappuccio (1) e collegare il manometro alla valvola (2).

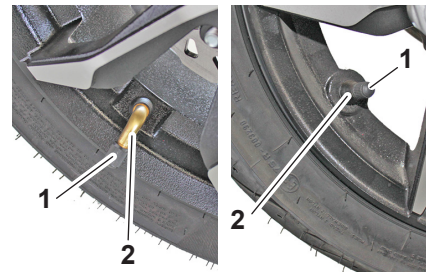



⚠ AVVERTENZA

- **Sostituire i pneumatici eccessivamente consumati da un gommista. L'utilizzo del veicolo con pneumatici eccessivamente usurati riduce la stabilità di marcia e può provocare la perdita del controllo del mezzo.**
- **Marcia a velocità moderata dopo il cambio di un pneumatico, per permettere alla superficie del pneumatico di "rodarsi", in modo da poter sviluppare al meglio le proprie caratteristiche.**

NOTA: Quando si sostituisce un pneumatico è necessario eseguire il bilanciamento della ruota.

Prima di ogni utilizzo, controllare sempre che i cerchi non presentino cricche, piegature, deformazioni o danneggiamenti di altro tipo. Se si riscontrano danneggiamenti, fare sostituire la ruota. Non tentare di eseguire nemmeno la minima riparazione di una ruota. In caso di deformazioni o di cricche, la ruota va sostituita.

5.1.I Controllo usura pastiglie freno

Controllare lo stato di usura delle pastiglie freno anteriore (1) e pastiglie freno posteriore (2).

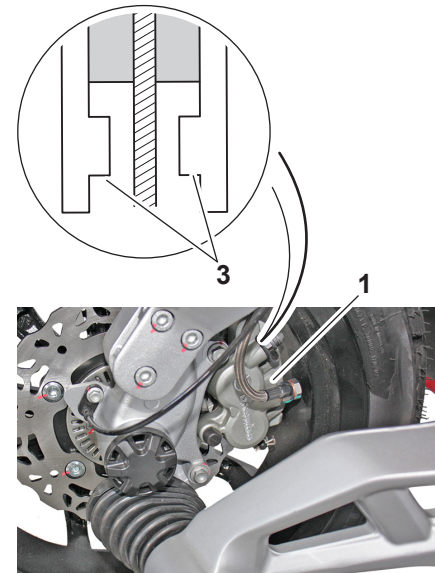



- Le pastiglie sono dotate di un indicatore di usura (3). Per controllare l'usura della pastiglia, controllare la posizione dell'indicatore d'usura (3) mentre si aziona il freno. Se una pastiglia si è usurata al punto che l'indicatore d'usura quasi tocca il disco del freno, sostituire le pastiglie in coppia.

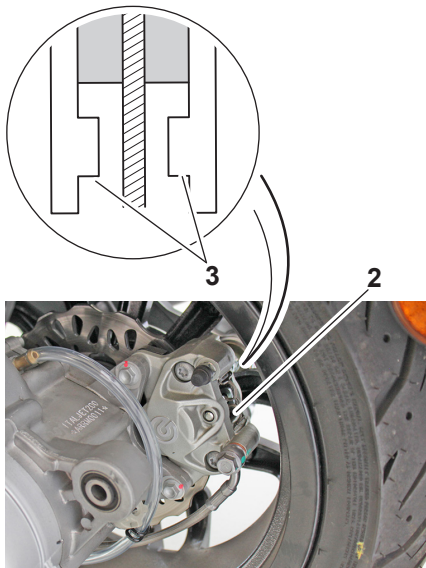

⚠ AVVERTENZA

Per la sostituzione delle pastiglie freno è necessario rivolgersi a un concessionario *Italjet*.

⚠ AVVERTENZA

Dopo la sostituzione delle pastiglie freno è necessario guidare con prudenza frenando in modo graduale per permettere alle pastiglie il corretto assestamento/accoppiamento con i relativi dischi.





5.1.m Controllo livello fluido freno anteriore/posteriore

- Posizionare il motociciclo in modo che la parte superiore del serbatoio freno sia parallela al terreno.
- Il livello del fluido nel serbatoio della pompa deve trovarsi al centro dell'orlo (1).

Un eventuale abbassamento del livello del fluido può permettere l'ingresso di aria nell'impianto con conseguente allungamento della corsa della leva; nel caso vi sia necessità di rabboccare rivolgersi al concessionario *Italjet*.

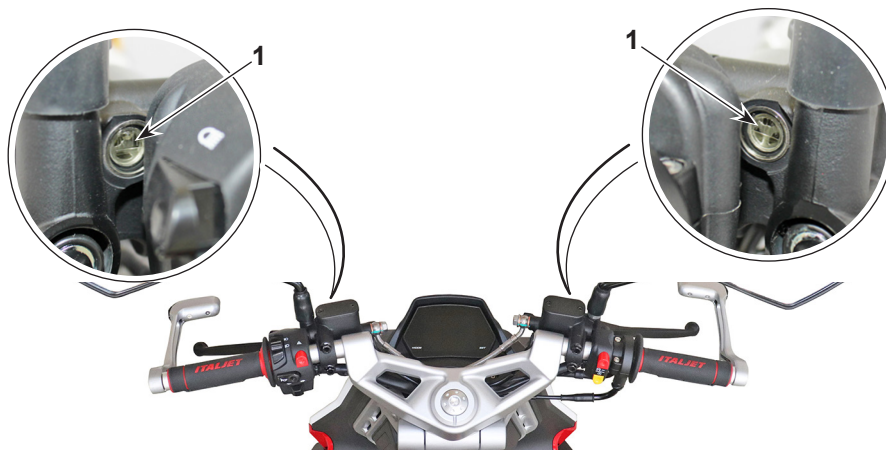

AVVERTENZA

Se la leva del freno risulta troppo “morbida”, si è in presenza di aria nella tubazione o di un difetto dell'impianto. Essendo pericoloso guidare il motociciclo in queste condizioni, fare immediatamente controllare l'impianto frenante presso il Concessionario *Italjet*.

ATTENZIONE

Non versare fluido freni su superfici verniciate o lenti (es. di fanali)

AVVERTENZA

Non mischiare due tipi di fluido diversi. Se si sceglie di impiegare una diversa marca di fluido, eliminare completamente quello esistente.

AVVERTENZA

Il fluido freni può causare irritazioni. Evitare il contatto con la pelle e gli occhi. In caso di contatto, pulire completamente la parte colpita e, qualora si trattasse degli occhi, chiamare un medico.





AVVERTENZA

- **Utilizzare solo il liquido freni prescritto secondo specifica; altrimenti le guarnizioni in gomma potrebbero deteriorarsi, causando perdite.**
- **Rabboccare con lo stesso tipo di liquido freni. L'aggiunta di un liquido dei freni diverso da DOT 4 può causare una reazione chimica nociva.**
- **Evitare infiltrazioni d'acqua o di polvere nel serbatoio liquido freni durante il rifornimento. L'acqua causa una notevole riduzione del punto di ebollizione del liquido e può provocare il "vapor lock", e lo sporco può intasare le valvole dell'unità idraulica ABS.**

ATTENZIONE

Il liquido freni può danneggiare le superfici verniciate o le parti in plastica. Pulire sempre immediatamente l'eventuale liquido versato.

Poiché le pastiglie freni si consumano, è normale che il livello liquido freni diminuisca gradualmente. Se il livello del liquido freni è basso è possibile che le pastiglie dei freni siano usurate e/o che vi sia una perdita nel circuito freni; pertanto, assicurarsi di controllare il livello d'usura delle pastiglie dei freni e la presenza di perdite nel circuito freni.

Se il livello del liquido freni cala improvvisamente, fare controllare il mezzo da un concessionario **Italjet** prima di continuare a utilizzarlo.

5.1.n Cambio del liquido freni

Far cambiare il liquido freni da un concessionario **Italjet** ogni 2 anni. Inoltre, fare sostituire le guarnizioni di tenuta delle pompe e delle pinze freno, nonché i tubi freno, agli intervalli elencati qui di seguito o prima nel caso in cui presentino danni o perdite.

- Guarnizioni di tenuta freno: ogni 2 anni
- Tubi freni: ogni 4 anni

5.1.o Controllo della cinghia trapezoidale

La cinghia trapezoidale va controllata e/o sostituita da un concessionario **Italjet** agli intervalli specificati nella tabella di manutenzione periodica.



5.1.p Controllo e lubrificazione del cavalletto centrale e del cavalletto laterale

Periodicamente, controllare sempre il funzionamento del cavalletto centrale e del cavalletto laterale, e lubrificare, se necessario, i perni (1) di guida e le superfici di contatto metallo/metallo.

⚠ AVVERTENZA

Se il cavalletto centrale o il cavalletto laterale non si alza e non si abbassa agevolmente, farlo controllare o riparare da un concessionario *Italjet*.

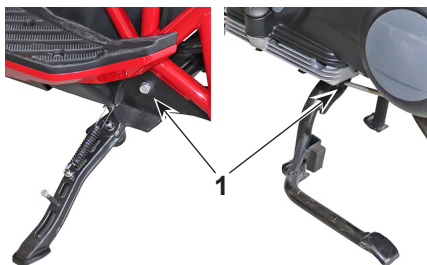

5.1.q Registrazione precarico molle ammortizzatori

L'ammortizzatore anteriore (1) e posteriore (2) hanno la possibilità di registrare il precarico della molla; per la registrazione allentare la controgiera (3) ed agire sulla ghiera (4), avvitandola si aumenta il precarico viceversa si diminuisce.

Avvitando la ghiera si comprime la molla e quindi si avrà una azione ammortizzante più rigida.

Svitando la ghiera si rilascia la molla e quindi si avrà una azione ammortizzante più morbida.

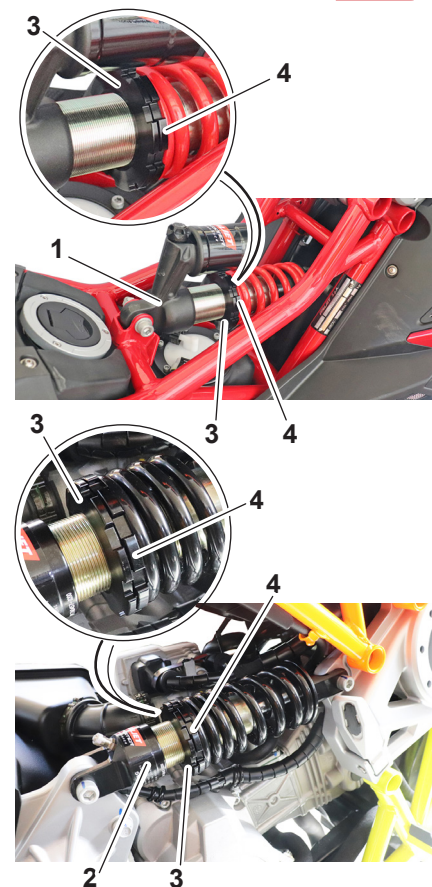



5.1.r Regolazione frenatura ammortizzatore anteriore

- Regolare la frenatura agendo sulla ghiera (1), ruotandola verso “+” la frenatura aumenta, ruotandola verso “-” la frenatura diminuisce.

La regolazione di fabbrica è 6 click da tutto chiuso.

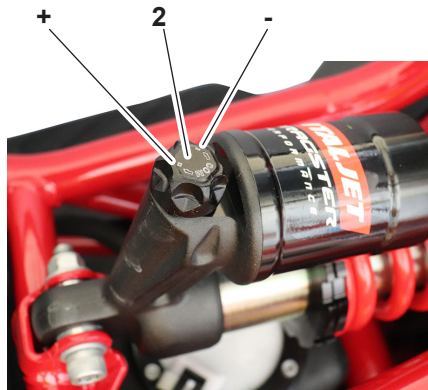

5.1.s Controllo piantone anteriore sterzo

Periodicamente va controllato l'eventuale gioco del piantone di sterzo.

- Posizionare il motociclo sul cavalletto centrale, una persona deve tenere il manubrio del motociclo in modo che sia stabile e un'altra persona deve cercare di muovere la ruota (1) nel senso della freccia “A” e nel senso della freccia “B”.

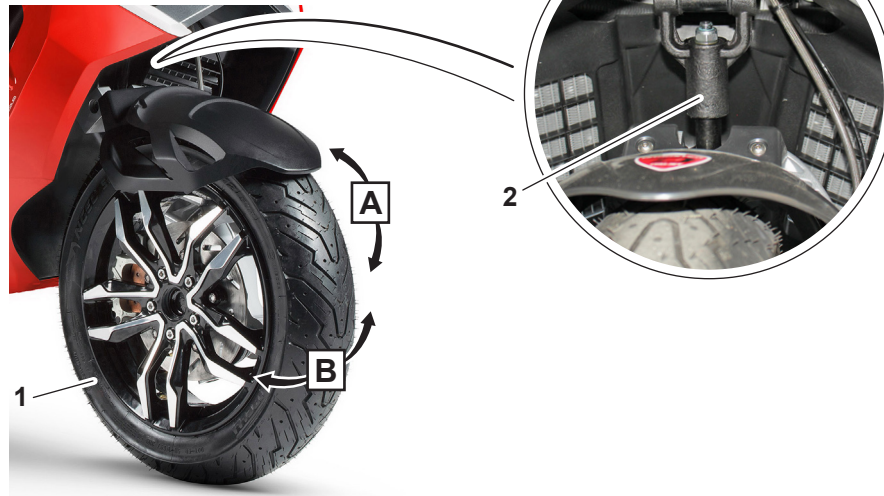

Se si riscontrano dei giochi eccessivi rivolgersi a un concessionario **Italjet** per controllare la movimentazione dello sterzo (2).





5.1.t Controllo e ricarica della batteria

Per accedere al vano batteria agire come segue:

- Sollevare la sella come descritto nel relativo paragrafo;
- Svitare le due viti (1) e rimuovere il sellino passeggero (2);

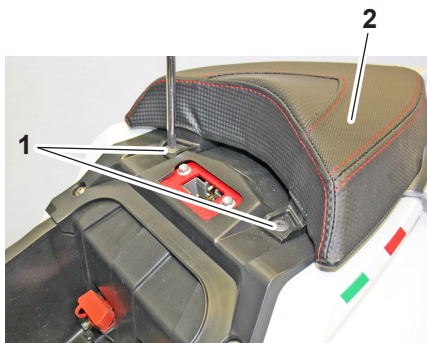

- Svitare le due viti (3) e rimuovere il carterino (4).



- Rimuovere per primo il cavo negativo NERO (5) poi quello positivo ROSSO (6) (in fase di rimontaggio, collegare per primo il cavo positivo ROSSO poi quello negativo NERO);
- Estrarre la batteria (7) dal proprio alloggiamento.

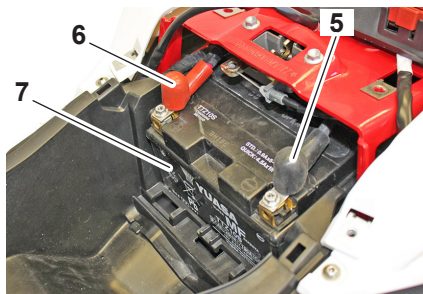

- Verificare, con l'ausilio di un voltmetro, che la tensione della stessa non sia inferiore a 12.5V. In caso contrario, la batteria necessita di un ciclo di ricarica.

- Utilizzando un caricabatteria a tensione costante, collegare per primo il cavo positivo ROSSO al morsetto positivo della batteria poi quello negativo NERO al morsetto negativo della stessa.

- Verificare sempre lo stato di carica della batteria prima di reinstallarla sul veicolo.

La batteria deve essere tenuta pulita ed i terminali ingrassati.

>>>





- Rimontare il tutto procedendo in senso inverso allo smontaggio facendo attenzione a incastrare il gancio (8) del sellino passeggero, nella sede (9) del supporto.

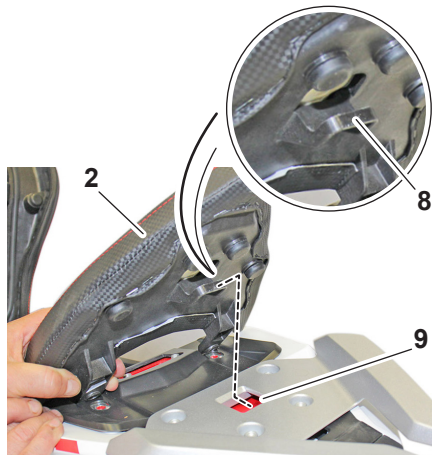

! PERICOLO

La batteria contiene acido solforico. Evitare il contatto con pelle, occhi e abiti.

RIMEDI:

CONTATTO CON LA PELLE

Sciacquare abbondantemente con acqua.

INGESTIONE:

Bevete grandi quantità di acqua e di latte.

Chiamate subito un medico. Non provocare vomito.

CONTATTO CON GLI OCCHI

Sciacquare con acqua per 15 minuti almeno e chiamate un medico.

ATTENZIONE

La batteria in caso di inutilizzo deve comunque essere ricaricata con ciclo di carica lento (0,6 A per 8 ore per batteria 12V- 6Ah) almeno ogni 3

settimane.

! AVVERTENZA

Le batterie producono gas esplosivi, arieggiare il locale quando si carica la batteria in ambienti chiusi. Quando si usa un carica-batteria, collegare la batteria al caricatore prima di accenderlo. Questa pratica evita la formazione di scintille in corrispondenza dei terminali della batteria che, potrebbero incendiare i gas contenuti nella batteria.



5.1.u Controllo/sostituzione dei fusibili

Il motociclo è dotato di due scatole fusibili, una posizionata sotto la sella e una posizionata sotto il pannello frontale.

Fusibili sotto la sella

- Sollevare la sella per accedere alla scatola fusibili (1).

Fusibile 2 (20 A)= Motorino ABS

Fusibile 3 (15 A)= Valvola ABS

Fusibile 4 (10 A)= Positivo, pannello strumenti, regolatore di tensione, iniezione

Fusibile 5 (20 A)= Fusibile di scorta

Fusibile 6 (15 A)= Fusibile di scorta

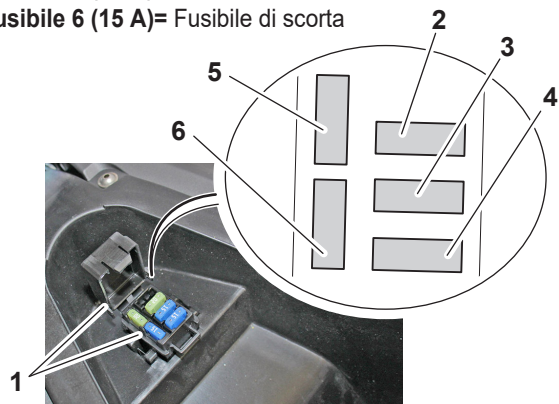

Fusibili sotto il pannello anteriore

- Svitare le viti (1) e rimuovere il pannello superiore (2).



- Tirare leggermente verso l'esterno il pannello (3) per sganciarlo dalla parte superiore.



- Prendere il pannello (3) con entrambe le mani e tirarlo verso l'esterno fino a sganciarlo dal supporto.

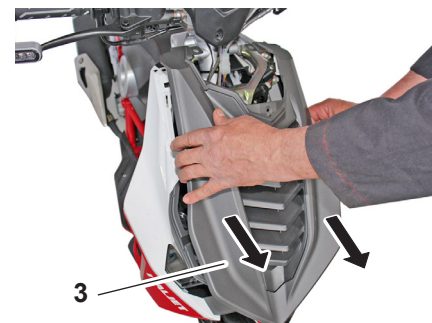



- La scatola fusibili (4) è posizionata nella parte superiore destra del motociclo.

Fusibile 5 (15A)= Luci, luce targa, rele indicatori di direzione, avvisatore acustico

Fusibile 6 (15A)= Iniezione, motorino avviamento

Fusibile 7 (15A)= Fusibile di scorta

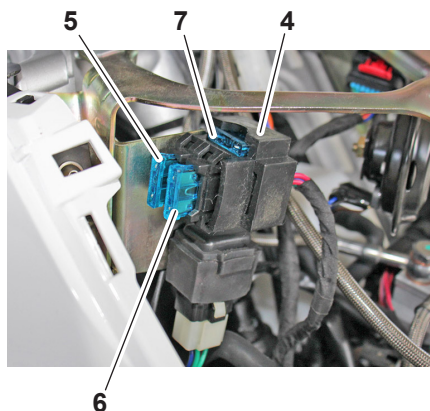

- Rimontare il tutto procedendo in senso inverso allo smontaggio facendo attenzione a incastrare i fermi (8) del pannello (3) nelle relative sedi (9).

ATTENZIONE

Non utilizzare un fusibile di un amperaggio superiore a quello originale, si potrebbe provocare danni all'impianto elettrico e possibile incendio.

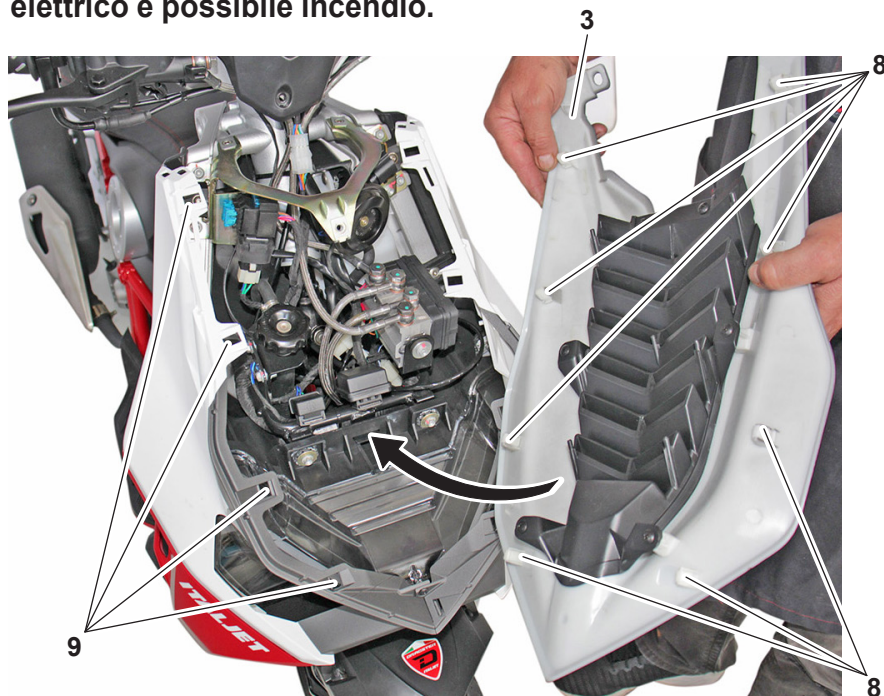



5.1.v Controllo luci

Controllo fascio luminoso fanale anteriore

- Per controllare se il fanale è orientato nel modo corretto mettere il motociclo, con in pneumatici gonfiati alla giusta pressione e con una persona seduta in sella, perfettamente perpendicolare con il suo asse longitudinale.
- Di fronte ad una parete o ad uno schermo, distante da esso 10 metri, tracciare una linea orizzontale corrispondente all'altezza del centro del fanale ed una verticale in linea con l'asse longitudinale del veicolo.

- Effettuare il controllo possibilmente nella penombra.
- Accendendo la luce abbagliante il limite superiore di demarcazione tra la zona oscura e la zona illuminata deve risultare ad una altezza non superiore a $\frac{9}{10}X$ dell'altezza da terra del centro del proiettore.
- Per effettuare la corretta regolazione recarsi presso il concessionario **Italjet**.

Luci e indicatori di direzione

- Il motociclo è dotato di luci e di indicatori a led, nel caso una luce non funzioni è necessario sostituirla recandosi presso il concessionario **Italjet**.

Connettori diagnostica

Per accedere ai connettori di diagnostica sollevare la sella.

Connettore (1) = Centralina ABS
Connettore (2) = Centralina motore

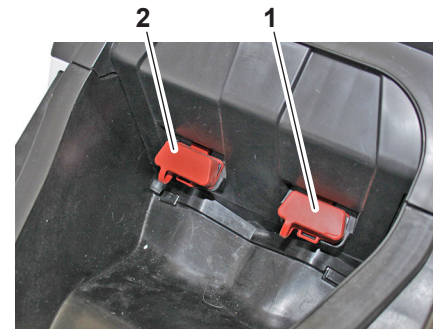
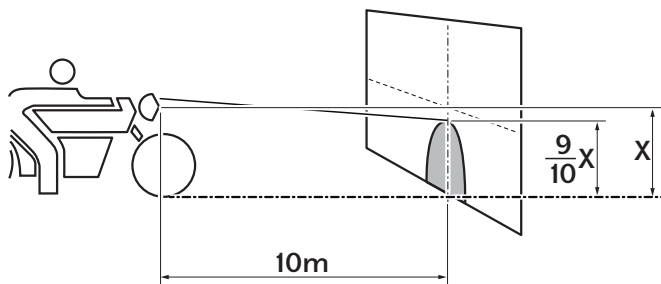



6.1 CURA E RIMESSAGGIO DEL MOTOCICLO

6.1.a Cura

La pulizia frequente e accurata del veicolo, oltre a migliorarne l'aspetto, ne migliorerà anche le prestazioni generali e prolungherà la vita utile di molti componenti. Inoltre, il lavaggio, la pulizia e la lucidatura consentiranno di ispezionare le condizioni del veicolo con maggior frequenza. Lavare il veicolo dopo averlo utilizzato sotto la pioggia o vicino al mare, poiché il sale è corrosivo per i metalli.

NOTA: *Le strade delle zone soggette a forti nevicate possono essere coperte di sale per evitare che ghiaccino. Questo sale può rimanere sulle strade fino a primavera inoltrata, per cui lavare il lato inferiore e i componenti della parte ciclistica dopo aver utilizzato il veicolo in tali aree.*

AVVERTENZA

Una pulizia inadeguata può causare danni estetici e meccanici. Non utilizzare:

- Idropulitrici ad alta pressione o pulitrici a getto di vapore. L'eccessiva pressione dell'acqua potrebbe causare la penetrazione d'acqua e il deterioramento di cuscinetti ruote, freni, guarnizioni della trasmissione e dispositivi elettrici.
- Prodotti chimici aggressivi, agenti detergenti abrasivi o cera sui componenti con finitura satinata. Le spazzole possono graffiare e

danneggiare la finitura satinata; utilizzare solo spugne morbide o asciugamani.

- Asciugamani, spugne o spazzole contaminati da prodotti detergenti abrasivi o prodotti chimici aggressivi, come ad esempio solventi, benzina, antiruggine, liquido freni, antigelo, ecc.



6.1.b Lavaggio

Prima

1. Parcheggiare il motociclo lontano dalla luce solare diretta e lasciare che si raffreddi.
Ciò eviterà la formazione di macchie di calcare.
2. Controllare che tutti i tappi, i coperci, i connettori e gli elementi di connessione elettrici siano ben installati.
3. Prestare attenzione a non far penetrare acqua all'interno del silenziatore.
4. Rimuovere la sporcizia della strada e le macchie d'olio con un agente sgrassante di qualità e una spazzola con setole in plastica o una spugna.

Durante

1. Sciacquare via ogni traccia di sgrassatore utilizzando acqua corrente. Evitare di spruzzare acqua direttamente nella marmitta, sul pannello portastrumenti, nell'ingresso dell'aria o all'interno di altre aree interne, come ad esempio i vani portaoggetti sotto la sella.
2. Lavare il motociclo con un detergente per auto di qualità miscelato con acqua fresca e una spugna morbida. Utilizzare uno spazzolino usato o una spazzola con setole in plastica per pulire i punti difficili da raggiungere.

ATTENZIONE

Se il motociclo è stato esposto al sale, utilizzare acqua fredda. L'acqua calda aumenterà le proprietà corrosive del sale.

3. Sciacquare bene con acqua pulita. Rimuovere tutti i residui di detergente; potrebbero essere dannosi per i componenti in plastica.

Dopo

1. Asciugare completamente il motociclo.
2. Lucidare con un prodotto specifico le superfici cromate, di alluminio e di acciaio inox.
3. Applicare uno spray anticorrosione su tutti i componenti in metallo, comprese le superfici cromate o nichelate.

AVVERTENZA

Non applicare spray a base di silicone o d'olio sulle selle, sulle manopole, sulle staffe poggiapiedi in gomma, sui dischi freno o sui battistrada dei pneumatici. In caso contrario, i componenti diventeranno scivolosi, con il rischio di causare la perdita di controllo del veicolo. Pulire accuratamente le superfici di questi componenti prima di utilizzare il veicolo.



4. Trattare i componenti in gomma, vinile e in plastica non verniciata con un apposito prodotto per la loro cura.
5. Stendere una cera non abrasiva su tutte le superfici verniciate.
6. Terminata la pulizia, avviare il motore e lasciarlo funzionare al minimo per qualche minuto per fare asciugare l'umidità residua.
7. Lasciare asciugare completamente il veicolo prima di rimessarlo o di coprirlo.

AVVERTENZA

Corpi estranei rimasti sui freni o sui pneumatici possono far perdere il controllo del veicolo.

- **Accertarsi che non ci sia lubrificante o cera sui freni o sui pneumatici.**
- **Se necessario, lavare i pneumatici con acqua calda e un detergente neutro.**
- **Se necessario, pulire i dischi e le pastiglie freno con apposito pulitore spray.**
- **Dopo il lavaggio del motociclo provare l'efficienza dei freni.**

6.1.c Rimessaggio

Rimessare sempre il veicolo in un luogo fresco e asciutto. Se necessario, proteggerlo dalla polvere coprendolo con un telo permeabile.

Accertarsi che il motore e l'impianto di scarico si siano raffreddati prima di coprire il motociclo.

ATTENZIONE

Per prevenire la corrosione, evitare scantinati umidi, ricoveri di animali (in considerazione della presenza di ammoniacca) e gli ambienti in cui sono immagazzinati prodotti chimici forti.



6.1.d Rimessaggio prolungato

Prima di rimessare il veicolo per un periodo di tempo prolungato (60 giorni o più) agire come segue:

1. Eseguire gli interventi di manutenzione.
2. Pulire il motociclo.
3. Fare il pieno del serbatoio carburante, aggiungendo lo stabilizzatore per carburante secondo le istruzioni del prodotto.
Far funzionare il motore per 5 minuti per distribuire il carburante trattato in tutto l'impianto del carburante.
4. Lubrificare il cavalletto laterale (se presente) e il cavalletto centrale.
5. Controllare e ripristinare la pressione dei pneumatici e poi sollevare il veicolo in modo che le ruote non tocchino terra.
6. Coprire lo scarico con un sacchetto di plastica per prevenire la penetrazione di umidità.
7. Rimuovere la batteria e caricarla completamente, oppure collegare un caricabatteria mantenitore per mantenere la carica ottimale della batteria.

ATTENZIONE

Verificare che la batteria e il relativo caricabatteria siano compatibili.

NOTA: Se la batteria verrà rimossa, caricarla una volta al mese e conservarla in un luogo temperato in cui la temperatura sia di 0-30 °C (32-90 °F).



7.1 DATI TECNICI

Lunghezza massima	1885 mm
Larghezza massima	750 mm
Altezza massima	1075 mm
Altezza sella	760 mm
Interasse	1350 mm
Altezza minima dal suolo	120 mm
Peso in ordine di marcia (peso a vuoto)	150 kg
Carico massimo veicolo (conducente + passeggero + bagaglio)	305 kg
Velocità massima	124 km/h
Olio motore	1300 cm ³ (Primo riempimento) 1250 cm ³ (Sost. olio motore & filtro) 1200 cm ³ (Solo sost. olio motore)
Olio di trasmissione	250 cm ³
Refrigerante	1.15 l (50% acqua + 50% liquido antigelo glicole etilenico)
Sedili	2
Cambio	variatore continuo automatico
Trasmissione	riduttore giri e cinghia
Tipo di telaio	Telaio in tubolare di acciaio ad alta resistenza, trave singola anteriore, doppia culla sovrapposta posteriore.
Angolo di sterzo	27.5°

>>>>>





Sospensione anteriore	Sistema Indipendente di Sterzo
Corsa sospensione anteriore	33 mm
Sospensione posteriore	Mono Ammortizzatore
Corsa sospensione posteriore	47 mm
Disco anteriore	Ø 200 mm freno a disco con trasmissione idraulica
Disco posteriore	Ø 220 mm freno a disco con trasmissione idraulica
Cerchi ruota	Cerchi in lega leggera
Cerchio ruota anteriore	MT 3.50 x 12"
Cerchio ruota posteriore	MT 4.00 x 13"
Tipo di pneumatico	Senza camera d'aria (Tubeless)
Pneumatico anteriore	120/70 - 12" 51 P (120/70-12 M/C, 58S)
Pneumatico posteriore	140/60-13" M/C 63P (140/60-13 M/C 63S)
Pressione di gonfiaggio standard pneumatico anteriore	190 kPa (1.9 bar)
Pressione di gonfiaggio standard pneumatico posteriore	200 kPa (2.0 bar)
Pressione di gonfiaggio standard pneumatico anteriore con passeggero	210 kPa (2.1 bar)
Pressione di gonfiaggio standard pneumatico posteriore con passeggero	250 kPa (2.5 bar)
Batteria	12V - 8.6Ah
Fusibili	20 - 15 - 15 - 15 - 15 - 10 A
Alternatore (del Tipo a magnete permanente)	12 V - 300W a 8000 rpm





Dati tecnici motore (300CC)

Motore modello	AZC
Tipo motore	Monocilindrico 4 tempi raffreddato a liquido, 4 valvole per cilindro con singolo albero a camme in testa
Potenza netta max.	17 kW (8000 r/min)
Coppia max.	23 N•m (6000 r/min)
Cilindrata	278 cc
Alesaggio / corsa	75 mm x 63 mm
Rapporto di compressione	11 : 1
Avviamento	Elettrico
Regime di minimo	1700 ± 170 rpm
Frizione	Frizione a secco centrifuga automatica
Cambio	Automatico
Raffreddamento	Sistema di raffreddamento a liquido con radiatore e ventola elettrica
Sistema di alimentazione	Iniezione elettronica
Diffusore del corpo farfallato	Ø 32 mm
Carburante	Benzina super senza piombo, minimo numero di Ottano di 95 (NORM)
Tipo di accensione	Elettronico
Candela	NGK CR8EKB





8.1 TABELLA PRODOTTI RACCOMANDATI

Prodotto	Descrizione	Caratteristiche
Olio motore semisintetico o sintetico	Olio motore	SAE 5W-40 JASO MA, MA2 API SL ACEA A3
Olio motore semisintetico o sintetico	Olio trasmissione	SAE 80W/90 75W/90 GL-4 / GL-5
Lubrificante L-XCDBB2	Grasso al litio con molibdeno per cuscinetti ed altri punti che necessitano di lubrificazione	NLGI 2
Fluido Freni DOT4	Fluido freni	FMVSS DOT4
Refrigerante motore FD-2B	Refrigerante O.A.T. technology	Protezione anticongelante fino a -40°C. Conforme alla norma CUNA 956-16.
Lubrificante / Olio motore 5W-30	Olio per spugna filtro dell'aria	-
GRASSO NEUTRO O PETROLATO	Poli batteria	-





IT - 70





9.1 LIBRETTO DI GARANZIA E DI SERVIZIO





9.1.a Il contenuto della garanzia

La Sua nuova moto è garantita esente da difetti originari in conformità alla **Direttiva 99/44 CE**.

La garanzia consiste nella sostituzione o riparazione gratuita del veicolo o di componenti che abbiano a manifestare, entro il suddetto termine, difetti di fabbricazione o, comunque, difetti preesistenti alla consegna veicolo.

La garanzia è valida solo se il vostro veicolo ha seguito il programma di manutenzione raccomandato e se tutti i tagliandi sono stati correttamente timbrati.

Le ricordiamo che la garanzia non opera nel caso di uso del veicolo in competizioni motociclistiche, in quanto trattasi di uso diverso e non compatibile con l'uso per il quale il suo veicolo è stato specificatamente progettato. Si ricordi che, come richiesto dalla legge, questa garanzia è prestata direttamente dal Suo Concessionario **Italjet**, al quale La invitiamo a rivolgersi per ogni necessità del caso.

Laddove il Suo Concessionario **Italjet** non possa soddisfare le sue richieste in un tempo ragionevole ovvero questo fosse per Lei più comodo, La invitiamo a rivolgersi ad un qualsiasi altro Concessionario **Italjet**, che sarà lieto di porsi al suo servizio.

9.1.b L'attivazione della batteria

Il suo veicolo è coperto da garanzia da difetti originari sin dal momento in cui Le viene consegnato dal Suo Concessionario **Italjet**.

Quando riceverà il suo veicolo **Italjet**, La invitiamo a sottoscrivere, unitamente al Concessionario, il Certificato di Consegna del veicolo che trova su questo manuale.

9.1.c Cosa fare in caso di richiesta di intervento in garanzia

Nel caso in cui, nel periodo di validità della garanzia, il Suo veicolo necessiti di un intervento straordinario di riparazione e/o sostituzione dipendente da un difetto originario, Le consigliamo di rivolgersi immediatamente al Concessionario ove ha acquistato il veicolo (il Suo Concessionario) descrivendogli il problema occorso e facendogli esaminare il veicolo.

Se l'intervento è reso necessario dall'avvenuto manifestarsi di un difetto originario, il Suo Concessionario provvederà ad effettuare gratuitamente la riparazione o la sostituzione necessaria nel minor tempo possibile.

9.1.d Condizioni di garanzia

Esclusioni

Sono esclusi dalla garanzia:

- I deterioramenti derivanti dal mancato rispetto del piano di manutenzione periodica prescritta da **Italjet**.
- I veicoli le cui riparazioni sono state effettuate con ricambi non conformi all'originale.
- I veicoli per cui non è stato eseguito il piano di manutenzione periodica o per i quali i tagliandi non sono stati debitamente timbrati.
- I veicoli utilizzati per competizioni/noleggio/uso gravoso fuoristrada.

Parti di consumo ed usura:

La garanzia non copre l'usura ed il deterioramento normale determinati dall'uso del veicolo per i seguenti pezzi:

- Candele.
- Catena di distribuzione.
- Pastiglie e dischi freno.
- Dischi e masse frizione.
- Pneumatici.
- Lampade e fusibili.
- Cavi di trasmissione e di comando.
- Tubi e tutte le altre parti in gomma.
- Cuscinetti.
- Filtro aria e benzina.
- Cinghia ed ingranaggi trasmissione secondaria.



Lubrificanti

La garanzia non copre i liquidi: olio, grasso, acido batteria e liquido di raffreddamento.

Limitazioni

Per tutti i veicoli: la garanzia della BATTERIA, della SELLA e delle PLASTICHE è limitata a 6 mesi.

- La garanzia non copre i costi di manutenzione e di revisione, né il costo dei pezzi necessari a queste operazioni.
- La garanzia non copre le spese conseguenti alla domanda di garanzia quali: spese addizionali per le comunicazioni, l'eventuale vitto ed alloggio, né altre spese derivate come compensazioni per il tempo perduto, perdite commerciali, spese di noleggio di veicolo sostitutivo, spese di trasporto.

Nota importante per la validità della garanzia:

- Il carnet di garanzia deve essere conservato con cura e deve essere presentato al concessionario ufficiale **Italjet** ad ogni intervento.
- I tagliandi di revisione devono essere compilati dal Concessionario che ha effettuato l'intervento.
- La garanzia può essere trasferita ai proprietari successivi fino alla sua scadenza.
- In caso di passaggio di proprietà, utilizzare il tagliando apposito presente in questo libretto.
- Il produttore si riserva il diritto di apportare delle modifiche e/o migliorie su tutti i suoi modelli senza l'obbligo di effettuare queste modifiche sui veicoli già in circolazione.





CERTIFICATO DI CONSEGNA

Data:

N° Telaio:

Modello:

N° Motore:

Il motociclo è stato preparato per la consegna eseguendo tutti i controlli e le operazioni di pre-consegna previste da ITALJET S.P.A. e completato di tutti gli eventuali accessori opzionali richiesti dal Cliente.

Al Cliente è stato consegnato il presente Libretto di Garanzia ed il Manuale di Uso e Manutenzione e sono stati illustrati i principali dispositivi di guida in dotazione al veicolo.

Timbro e firma del concessionario

L'organizzazione ufficiale di vendita e la società ITALJET S.P.A., dichiarano che il trattamento dei dati personali dell'acquirente, con riferimento alla Legge n° 675 del 1996 e successive modifiche, può avvenire anche senza necessità del consenso del Cliente, in attuazione dell'obbligo di fornitura del Servizio di Assistenza.

CLIENTE

Nome:

Cognome:

Indirizzo:

Città:

CAP:

Recapito telefonico:

Dichiaro di ricevere oggi il motociclo sopra indicato completo e conforme alle mie aspettative, nonché dichiaro di ricevere il presente Libretto di Garanzia ed il Manuale di Uso e Manutenzione. Autorizzo ITALJET S.P.A. al trattamento dei miei dati personali ai fini della fornitura del Servizio di Assistenza ai sensi della Legge 675/1996 e successive modifiche.

Firma del cliente

Copia per ITALJET S.P.A.



Area containing multiple horizontal dotted lines, likely a template for text or data entry.





COMUNICAZIONE DI PASSAGGIO DI PROPRIETÀ

Data: Km:

N° Telaio:

Modello:

N° Motore:

Il sottoscritto: _____

Nome: _____

Cognome: _____

Indirizzo: _____

Città: _____ CAP: _____

Recapito telefonico: _____

Inviare in busta chiusa a:
ITALJET S.P.A. , Via dell'agricoltura, 2 - 40023 Castel Guelfo di Bologna (BO) - Italia

L'organizzazione ufficiale di vendita e la società ITALJET S.P.A., dichiarano che il trattamento dei dati personali dell'acquirente, con riferimento alla Legge n° 675 del 1996 e successive modifiche, può avvenire anche senza necessità del consenso del Cliente, in attuazione dell'obbligo di fornitura del Servizio di Assistenza.



CLIENTE



Comunica a ITALJET S.P.A. che in data odierna ha ceduto la proprietà del veicolo sopraindicato al Signor:

Nome: _____

Cognome: _____

Indirizzo: _____

Città: _____

CAP: _____

Recapito telefonico: _____

consegnandogli il presente Libretto di Garanzia ed il Manuale di Uso e Manutenzione in dotazione.

Copia per ITALJET S.P.A.



A series of 12 horizontal dotted lines, evenly spaced, intended for text entry.





Spazio per la conservazione della documentazione fiscale comprovante l'avvenuta esecuzione dei tagliandi di manutenzione previsti.



TAGLIANDO	<input type="text"/>	DATA	<input type="text"/>	Km	<input type="text"/>	Firma del Cliente	<input type="text"/>	Timbro del Concessionario	<input type="text"/>
TAGLIANDO	<input type="text"/>	DATA	<input type="text"/>	Km	<input type="text"/>	Firma del Cliente	<input type="text"/>	Timbro del Concessionario	<input type="text"/>
TAGLIANDO	<input type="text"/>	DATA	<input type="text"/>	Km	<input type="text"/>	Firma del Cliente	<input type="text"/>	Timbro del Concessionario	<input type="text"/>
TAGLIANDO	<input type="text"/>	DATA	<input type="text"/>	Km	<input type="text"/>	Firma del Cliente	<input type="text"/>	Timbro del Concessionario	<input type="text"/>
TAGLIANDO	<input type="text"/>	DATA	<input type="text"/>	Km	<input type="text"/>	Firma del Cliente	<input type="text"/>	Timbro del Concessionario	<input type="text"/>
TAGLIANDO	<input type="text"/>	DATA	<input type="text"/>	Km	<input type="text"/>	Firma del Cliente	<input type="text"/>	Timbro del Concessionario	<input type="text"/>
TAGLIANDO	<input type="text"/>	DATA	<input type="text"/>	Km	<input type="text"/>	Firma del Cliente	<input type="text"/>	Timbro del Concessionario	<input type="text"/>
TAGLIANDO	<input type="text"/>	DATA	<input type="text"/>	Km	<input type="text"/>	Firma del Cliente	<input type="text"/>	Timbro del Concessionario	<input type="text"/>
TAGLIANDO	<input type="text"/>	DATA	<input type="text"/>	Km	<input type="text"/>	Firma del Cliente	<input type="text"/>	Timbro del Concessionario	<input type="text"/>
TAGLIANDO	<input type="text"/>	DATA	<input type="text"/>	Km	<input type="text"/>	Firma del Cliente	<input type="text"/>	Timbro del Concessionario	<input type="text"/>

FISSARE con una graffetta o una pinzatrice la Ricevuta Fiscale o Scontrino Fiscale che attestano l'avvenuta esecuzione dei tagliandi di manutenzione.







EN

ENGLISH

Italjet declines any responsibility for any errors which may have occurred in compiling this manual and reserves the right to make any changes required by the evolutionary development of its products. The illustrations shown are indicative and may not correspond exactly to the particular treatise. Even partial reproduction of this publication is prohibited without written authorization.





DRAGSTER

A large, stylized red letter 'D' with a white negative space cutout in the middle, positioned below the word 'DRAGSTER'.



INDEX

1.1 PRESENTATION	EN - 5	2.6 COMMANDS	EN - 19	3.2 INSTRUCTIONS FOR USING THE MOTORCYCLE	EN - 32
1.2 IMPORTANT WARNINGS	EN - 5	2.6.a Key block	EN - 19	3.2.a Break-in instructions.....	EN - 32
1.3 SYMBOLS PRESENT IN THE MANUAL	EN - 6	2.6.b “ Lock” steering lock	EN - 20	3.2.b Identification of operating problems	EN - 32
1.4 SAFE RIDING AND MOTORCYCLE SAFETY	EN - 7	2.7 LEFT CONTROL BLOCK	EN - 21	3.3 RIDER AND PASSENGER GET ON / GET OFF THE BIKE	EN - 33
1.5 ANTI-LOCK BRAKING SYSTEM - ABS	EN - 8	2.8 RIGHT CONTROL BLOCK	EN - 22	3.3.a General rules	EN - 33
1.6 RISKS RELATED TO CARBON MONOXIDE	EN - 8	2.8.a EMERGENCY switch to stop the engine.....	EN - 22	3.3.b Rider Get On	EN - 33
1.7 SAFETY INFORMATION	EN - 9	2.8.b Engine start button.....	EN - 22	3.3.c Passenger Get On	EN - 34
1.7.a Accessories.....	EN - 9	2.9 ACCELERATOR CONTROL	EN - 22	3.3.d Get Off the bike	EN - 35
1.7.b Transportation of the scooter	EN - 9	2.10 FRONT BRAKE CONTROL	EN - 23	3.4 REAR VIEW MIRRORS ADJUSTMENT	EN - 35
1.7.c Foldable key.....	EN - 9	2.11 REAR BRAKE CONTROL	EN - 23	4.1 STARTING OF THE MOTORCYCLE	EN - 36
2.1 COMPONENTS OF THE SCOOTER	EN - 10	2.12 FUEL TANK	EN - 24	4.1.a Use of the accelerator...EN - 37	
2.2 CONTROLS AND INSTRUMENTS	EN - 13	2.13 FUEL	EN - 25	4.1.b Using the brakes	EN - 37
2.3 DATA FOR IDENTIFICATION ..EN - 14		2.13.a Different types of petrol	EN - 25	4.1.c Stopping the motorcycle and engine	EN - 38
2.4 INSTRUMENTATION	EN - 15	2.13.b Catalytic converter	EN - 26	4.1.d Stopping the engine in an emergency	EN - 38
2.4.a Indicator and warning lights	EN - 15	2.14 ACCESSORY PARTS AND USB SOCKET	EN - 26	4.1.e Parking the motorcycle..EN - 38	
2.4.b Digital Instrument	EN - 17	2.14.a To use the USB socket..EN - 26		5.1 MAINTENANCE AND PERIODIC CHECKS	EN - 39
2.5 ADJUSTMENT AND DISPLAY SETTING	EN - 18	2.14.b Storage compartment under the saddle	EN - 27	5.1.a Periodic maintenance....EN - 39	
		2.14.c Side stand	EN - 28	5.1.b Check oil level	EN - 43
		2.14.d Central stand.....	EN - 29		
		3.1 CHECKS BEFORE USE	EN - 30		





5.1.c	Engine oil and filter replacement	EN - 43	5.1.s	Front steering column check	EN - 56
5.1.d	Check the coolant level	EN - 46	5.1.t	Checking and charging the battery	EN - 57
5.1.e	Cleaning the engine air filter	EN - 46	5.1.u	Checking / replacing the fuses	EN - 59
5.1.f	Cleaning the transmission air filter	EN - 48	5.1.v	Lighting control	EN - 61
5.1.g	Spark plug check	EN - 49	6.1 MOTORCYCLE CARE AND STORAGE	EN - 62	
5.1.h	Check tires and relative pressure	EN - 49	6.1.a	Care	EN - 62
5.1.i	Tire check	EN - 50	6.1.b	Washing	EN - 63
5.1.l	Check the wear of the brake pads	EN - 51	6.1.c	Storage	EN - 64
5.1.m	Front / rear brake fluid level check	EN - 53	6.1.d	Prolonged storage	EN - 65
5.1.n	Changing the brake fluid	EN - 54	7.1 TECHNICAL DATA	EN - 66	
5.1.o	Checking the V-belt	EN - 54	8.1 PRODUCTS TABLE RECOMMENDED	EN - 69	
5.1.p	Checking and lubricating the center stand and side stand	EN - 55	9.1 GUARANTEE AND SERVICE BOOK	EN - 71	
5.1.q	Shock absorber spring preload adjustment	EN - 55	9.1.a	The content of the guarantee	EN - 72
5.1.r	Front shock absorber braking adjustment	EN - 56	9.1.b	Battery activation	EN - 72
			9.1.c	What to do in the event of a warranty claim	EN - 72
			9.1.d	Warranty conditions	EN - 72



1.1 PRESENTATION

Welcome to the *Italjet* motorcycle family!

Your *Italjet* scooter has been designed and built to be the best in its category. The instructions in this manual have been prepared to provide a simple and clear guide to the use and maintenance of the motorcycle. To obtain the best performance from it, it is recommended to carefully follow the instructions given in this manual. It contains instructions for carrying out the necessary maintenance operations. More specific or major repairs or maintenance require the work of expert mechanics and the use of appropriate equipment. It is advisable to contact the *Italjet* Official Network which has all the tools to offer the best service to the Customer.

WARNING

Finally, remember that the **“Use and maintenance manual” must be considered an integral part of the motorcycle and as such remain attached to it even in the event of resale.**

This motorcycle uses components designed and manufactured using state-of-the-art systems and technologies.

For the correct operation of the motorcycle, it is necessary to follow the inspection and maintenance table given in this manual.



1.2 IMPORTANT WARNINGS

The *DRAGSTER* models are motorcycles for ROAD use, covered by a contractual guarantee, provided that THE STANDARD CONFIGURATION HAS TO BE KEPT and maintenance interventions are respected.



1.3 SYMBOLS PRESENT IN THE MANUAL

Particularly important information is highlighted by the following symbols.

 DANGER	DANGER is used to report potential risks of injury. Follow all safety messages reported by this symbol to avoid injury or death.
 WARNING	WARNING indicates a hazardous situation which, if not avoided, could result in death or serious injury.
 ATTENTION	ATTENTION indicates special precautions to be taken to avoid damage to the vehicle.
NOTE	<i>NOTE</i> contains important information on the subject matter.



1.4 SAFE RIDING AND MOTORCYCLE SAFETY

Below we list some basic principles for safe driving of your scooter.

- Remember that your safety and the safety of the passenger come first. Arriving safely at the end of the journey must be the main objective.
- The rider and passenger must wear suitable protective clothing such as overalls, gloves, shoes, helmet approved for motorcycle use.
- The rider's position on the bike must be such as to have the widest possible view of the road you are traveling on.
- Drive the motorcycle carefully, set the speed according to the traffic and the type of road conformation. A smooth ride allows you to assess hazards and set cornering trajectories more precisely.
- Always pay attention to the WARNING signs and modulate the speed according to the indications given.
- Always respect the speed limits.
- Always evaluate the condition of the road surface and modulate the speed

according to it.

- Limit your speed in case of rain and especially in case of puddles on the asphalt.
- When driving on wet surfaces or on surfaces with poor grip (snow, ice, mud, etc.), keep a moderate speed, avoiding sudden braking and sudden maneuvers.
- Maintain a safe distance from vehicles in front of you.
- Before overtaking, check that there are no obstacles in front of the vehicle to be overtaken and always check through the rear-view mirrors that there are no other vehicles approaching from behind.
- Braking using both the front and rear brakes at the same time: this helps to maintain vehicle stability.
- If you feel tired or drowsy, stop and rest. Continuous use of the brakes downhill could cause the brake pads to overheat, limiting the braking efficiency.
- Do not turn off the engine when driving downhill.
- When traveling with the passenger, increase safety distances from the vehicles in front of you and take passenger's weight into account when braking and when you must make a

bend or overtake.

- The position of the driver and passenger are important for the control of the vehicle.
- While driving, the rider must keep both hands on the handlebars and both feet on the footrests to maintain control of the motorcycle.
- The passenger must always hold onto the driver or handles with both hands and keep both feet on the footrests. Never carry a passenger unless he can firmly place both feet on their footrests.
- Never drive under the influence of alcohol or drugs.
- This scooter is designed for on-road use only. It is not suitable for off-road use.
- Do not use laces, ropes etc ... to secure the luggage, use only approved bags suitable for the type of motorcycle you use.
- The maximum transportable load (rider, passenger, and luggage) must not exceed 155 kg (342 lb.). Under no circumstances should the weight of the baggage exceed 5 kg (11 lb.).



1.5 ANTI-LOCK BRAKING SYSTEM - ABS

ABS is an electro-mechanical braking aid system:

prevents the wheels from locking during braking, helping to maintain vehicle stability in the presence of slippery, wet, or dirty road surfaces.

In conditions of poor grip, the system can intervene by lengthening the braking distance (e.g., presence of gravel or slippery surface), but in any case, guarantees the minimum space for that particular road surface.

- The ABS system does not operate at speeds below 10 km / h. When, during braking, the system comes into operation, pulsations are felt on the brake lever: this sensation should not lead to loosening the pressure on the lever, as this would cancel the action of the system. Moreover, the presence of the ABS system must not lead to behaviors or driving behaviors that exceed the usual rules of prudence.
- Always use recommended pads and tires to ensure correct operation of the ABS system.

1.6 RISKS RELATED TO CARBON MONOXIDE

Exhaust gases contain carbon monoxide, a colorless and odorless gas. Breathing carbon monoxide can cause unconsciousness and death.

If the engine is started in completely or partially enclosed rooms, the air you breathe can contain a dangerous amount of carbon monoxide. Never start the motorcycle in a garage or other enclosed place.

 **DANGER**

Carbon monoxide is a toxic gas. Breathing it can cause unconsciousness and death. Avoid any areas or activities that may expose you to carbon monoxide.



1.7 SAFETY INFORMATION

1.7.a Accessories

Choosing the right accessories for your vehicle is an important decision. Use only original accessories, available from **Italjet** dealers that have been tested and approved for use on your vehicle.

The addition of electrical accessories must be done with caution. If the electrical accessories exceed the capacity of the scooter's electrical system, an electrical system failure may occur.

1.7.b Transportation of the scooter

Before transporting your scooter in another vehicle, please observe the following instructions.

- Remove all loose objects from the scooter.
- Orient the front wheel in the running position in a straight line on the trailer or on the truck bed and lock it appropriately to prevent it from moving.
- Secure the scooter with appropriate ropes or anchoring straps to solid components of the scooter itself, such as the frame (and not for example to the direction indicators or other components that could break). Carefully choose the location of the straps to prevent them from rubbing against painted parts during transport.
- The suspension, if possible, should be partially compressed, so that the scooter does not jolt excessively during transport.

1.7.c Foldable key

The key (1) of the Dragster is foldable. To avoid breaking it, it is recommended to bend the handle of the key (1) perpendicular to the key itself while the vehicle is moving.





2.1 COMPONENTS OF THE SCOOTER

Right side view

1. Rider footpegs
2. Rider seat
3. Passenger seat
4. Passenger handles
5. Passenger footrests
6. Rear shock absorber
7. Exhaust silencer
8. Glove compartment





Left side view

1. Front wheel
2. Front brake disk
3. Front brake caliper
4. Front single arm
5. Single arm shock absorber
6. Under-saddle compartment access lock
7. Voltage regulator
8. Engine
9. Air filter
10. Central stand
11. Transmission air filter
12. Rear brake disk and caliper
13. Rear wheel
14. Fuel tank cap
15. Fuel tank
16. Side kickstand





Front and rear view

1. Right rear-view mirror
2. Left rear-view mirror
3. Right direction indicator
4. Left direction indicator
5. Front light
6. Right radiator
7. Left radiator
8. Rear light
9. Left rear arrow
10. Right rear arrow
11. License plate light
12. License plate holder

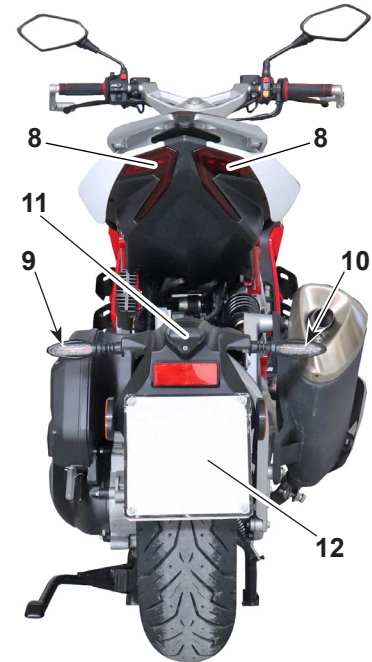
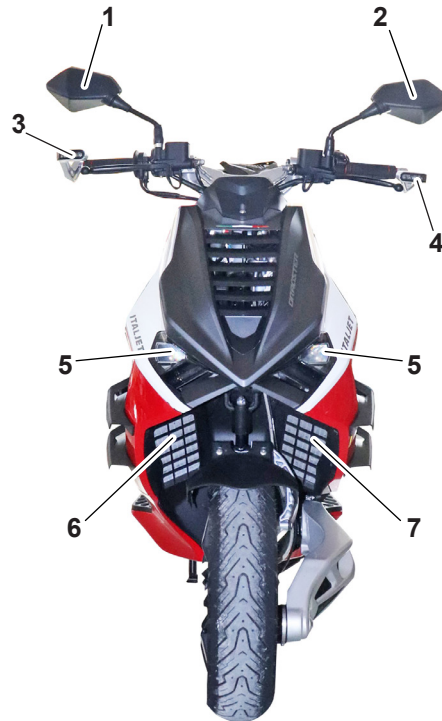



2.2 CONTROLS AND INSTRUMENTS

1. Left knob
2. Left control block
3. Rear brake lever
4. Throttle control
5. Right control block
6. Front brake lever
7. Ignition switch
8. USB socket
9. Digital tool

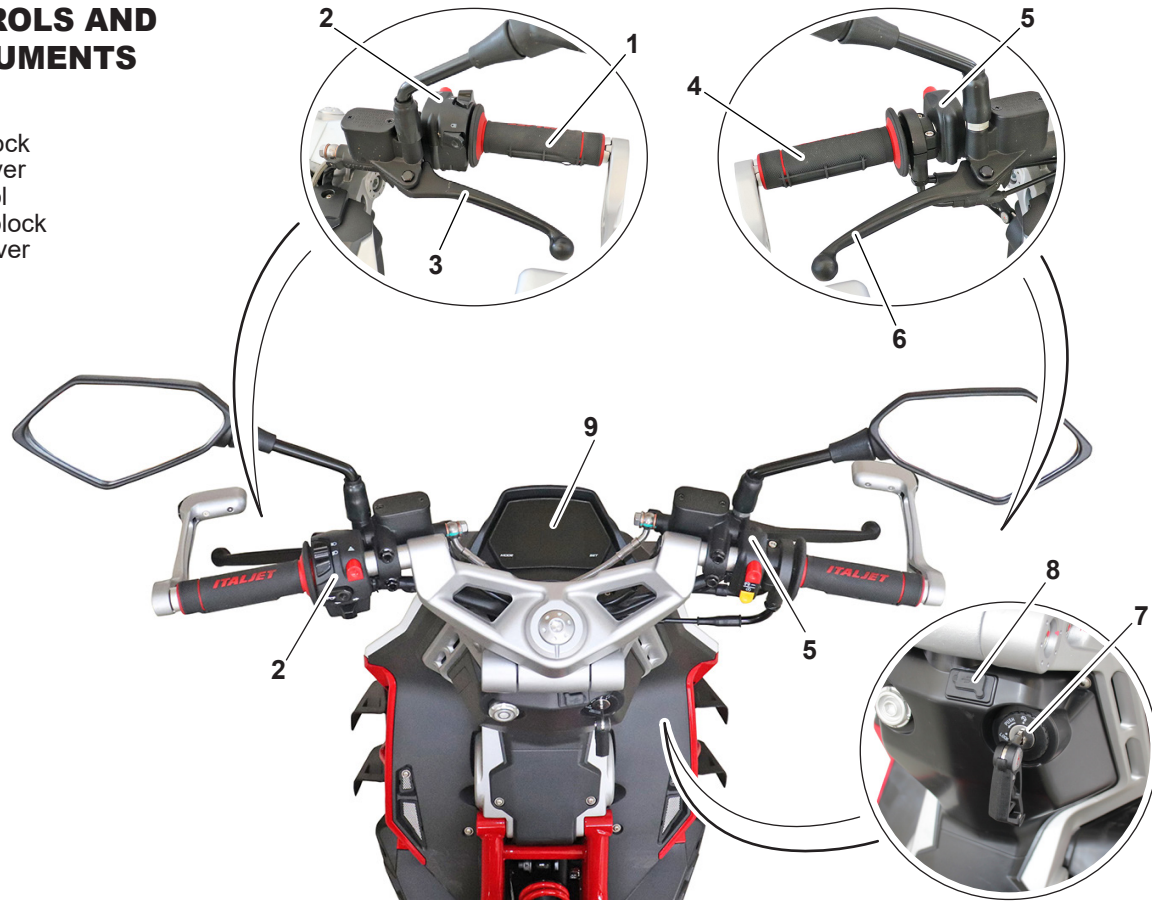



2.3 DATA FOR IDENTIFICATION

The engine identification number is stamped on the rear / top of the crankcase, while **the serial number is stamped on the frame** under the seat.

Always refer, also noting it in this booklet, the number stamped on the frame when ordering spare parts or asking for information about your motorcycle.

ENGINE SERIAL NUMBER

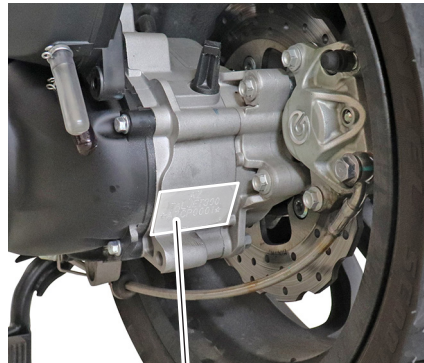

MOTORCYCLE SERIAL NUMBER





2.4 INSTRUMENTATION

2.4.a Indicator and warning lights

- 1) Left turn signal warning light.
- 2) Right turn signal warning light.
- 3) Insufficient engine oil pressure warning light.
- 4) High beam warning light.
- 5) High coolant temperature warning light.
- 6) Low fuel warning light.
- 7) ABS warning light.
- 8) Engine fault warning light.

Left turn signal warning light “←”

The light flashes when the left turn indicator is inserted using the special control lever located on the left control block.

Right turn signal warning light “→”.

The light flashes when the right direction indicator is inserted using the special control lever located on the left control block.

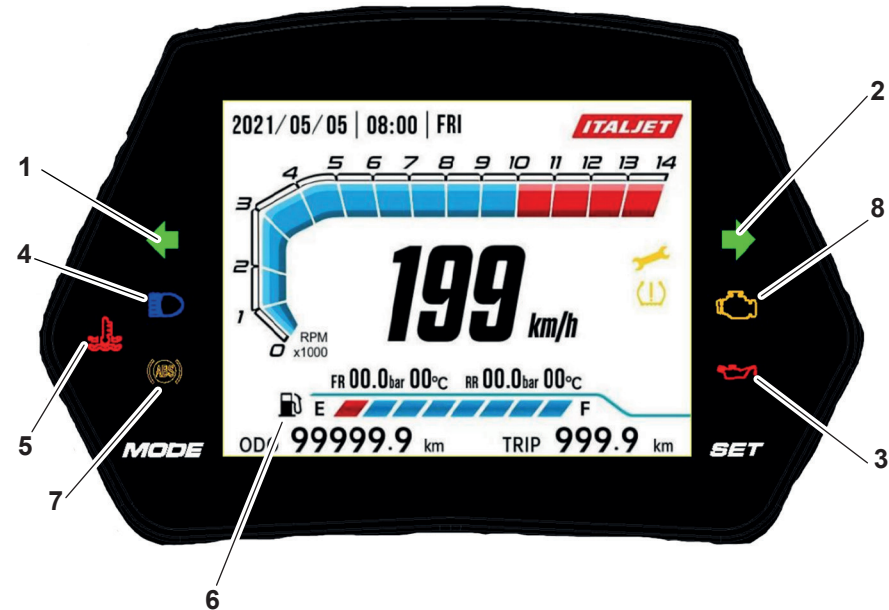

Insufficient engine oil pressure warning light “”.

It lights up with the ignition key in the “ON” position and should go out when the engine is running. If it stays on or lights up with the engine run-

ning, stop the engine and check the oil level as described in the relevant paragraph or contact your dealer to have the fault checked.





WARNING

Do not use the motorcycle with insufficient oil pressure, possible engine failure.

High beam warning light “”.

The light comes on when the high beam is switched on using the appropriate control located on the left control block.

High coolant temperature warning light “”.

It lights up when the coolant temperature has reached the maximum allowed value.

WARNING

Stop the motorcycle and turn off the engine. Do not use the motorcycle with a high coolant temperature, possible engine failure.

- Wait for the coolant to cool then check the level as described in the relevant paragraph or contact your trusted dealer to check the fault.

Low fuel warning light “”

If the warning light comes on while the motorcycle is being used, it indicates that the fuel level has reached the reserve level (2 liters), indicating a limited range of travel; refuel as soon as possible.

ABS warning light “”

By turning the key, the ABS control unit performs a self-diagnosis, the warning light comes on for a few seconds and then goes off indicating no anomalies.

If, on the other hand, the warning light comes on while the motorcycle is running, it indicates that there is a fault in the ABS braking system:

- Stop and turn off the engine.
- Wait a few minutes and restart the engine. If the warning light comes on again, contact the nearest *Ital-*

jet Dealer to have the ABS system checked.

Engine fault warning light “”

By turning the ignition key, the engine control unit performs a self-diagnosis, the warning light comes on for a few seconds and then goes out indicating no anomalies.

If the warning light comes on while the engine is running, it indicates that there is a fault with the engine or the injection system;

- Stop and turn off the engine.
- Wait a few minutes and restart the engine. If the warning light comes on, contact the nearest *Italjet* Dealer to carry out a check on the self-diagnosis system.



2.4.b Digital Instrument

- 1) Speed indicator (Speedometer)
km / h - mi / h.
- 2) Date / time / day.
- 3) Fuel gauge.
- 4) Total km/mi travelled indicator.
- 5) Partial km/mi travelled indicator.
- 6) Expired scheduled maintenance warning light.
- 7) "MODE" button.
- 8) "SET" button.

Speedometer (1)

Indicates the speed of the motorcycle; the speed can be indicated in km / h or mi / h depending on how the unit of measurement has been set.

Date/Time/Day of the week (2)

- 2a) Indicates the date; it can be displayed with "year/month/day" or with "day/month/year"
- 2b) Indicates the time; it can be set with a 24-hour or 12-hour scale.
- 2c) Indicates the day of the week.

Fuel Gauge (3)

Indicates the fuel level inside the tank; completely visible scale (3a) indicates the maximum level, non visible scale (3a) indicates the mini-

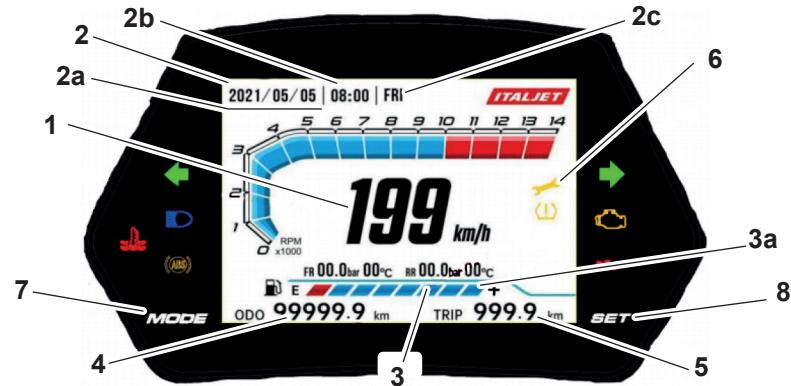

mum level, the light "M" lights up.

Total km/mi travelled indicator (4)

This part of the display shows the total km/mi travelled.

Partial km/mi travelled indicator (TRIP) (5)

This part of the display shows the partial km/mi travelled since the last reset.

Expired scheduled maintenance warning light (6)

The warning light flashes when maintenance interval is in 100km / 62mi. The warning light remains steady when the km / mi of the mainte-

nance interval has been exceeded and remains steady until reset.

After performing the maintenance, display TOTAL ODO, then press the "mode" button (7) for more than 10 seconds; the maintenance indicator goes off.

MODE button (7)

The "mode" button allows you to scroll through the software.

SET button (8)

The "set" button allows you to set the unit of measure and to delete partial counters.



2.5 ADJUSTMENT AND DISPLAY SETTING

DANGER

All adjustments must be made with the motorcycle stationary.

Km / mi setting and 24 hours / 12 hours clock

- Press the **“mode”** button until the total km / mi is displayed.
- Press and hold the **“set”** button for at least ten seconds to switch from the unit of measurement km + 24 hours clock to mi (miles) + 12 hours clock and vice versa; the partial counters are reset.

Time setting

- Press the **“mode”** and **“set”** buttons at the same time for more than two seconds, the hours and minutes start flashing.
- Press the **“mode”** key to increase the hours and the **“Set”** key to increase the minutes.
- Press the **“mode”** and **“set”** buttons simultaneously for more than two seconds to confirm the time setting.

Setting km / mi and partial hours “Trip A or Trip B”

- Press the **“mode”** button until “Trip A” or “Trip B” is displayed, by quickly pressing the **“set”** button you can switch between displaying the partial km / mi traveled to the partial hours for the trip.
- To reset the partial km / mi traveled and the partial time, press the **“set”** button for more than two seconds, the values are reset, and a new count starts again.





2.6 COMMANDS

2.6.a Key block

The key block has three positions:

↻ motorcycle starting position (non-removable key);

⊗ key extraction position;

“**lock**” steering locking position (removable key).

- Key extraction position “⊗”

By turning the key to position “⊗” the engine and the lights switch off and it is possible to remove the key from the block.

- Starting position “↻”

From position “⊗” (key extraction) turn the key (1) clockwise to position “↻”; the lights, the display will light up and the motorcycle can be started.





2.6.b “ Lock” steering lock

To lock the steering operate as follows:

- Turn the handlebar fully to the left
- Insert the key (1) on the block (2) in position .
- Press the key (1) and turn it anti-clockwise to the “**lock**” position.
- Remove the key (2).





To unlock the steering, operate in reverse.





2.7 LEFT CONTROL BLOCK

The left block has the following commands:

1.  Dazzling flashing.
2.  Low beam / high beam switch.
3.  Emergency light switch.
4.  Horn.
5.  Direction indicator switch.





High beam “”



Press the button (1) when the dipped headlights are on.

Low beam / main beam switch “ / ”

Depending on the position of the switch (2), the dipped or main beams light up:

-  Illuminated low beam lights.
-  Illuminated high beam lights.

Emergency light switch “”



By pressing the switch (3) all the direction indicators flash simultaneously and the “(symbol)” and “(symbol)” lights flash on the dashboard “” and “.

NOTE: Use the Hazard lights only when necessary to warn other vehicles that your motorcycle is stationary. Using the Emergency lights with the engine off could drain the batteries.

Horn “”

Press the button (4) to activate the horn.

Direction indicator switch “ / ”



Moving the switch (5) towards “” inserts the left direction indicator, moving the switch (5) towards “” inserts the right direction indicator. Once released, the switch returns to the central position. To turn off the inserted direction indicator, press the switch once it is in the central position.





2.8 RIGHT CONTROL BLOCK

The right block has the following commands:

1.  Emergency switch engine stop.
2.  Engine start button.



2.8.a EMERGENCY switch to stop the engine



WARNING

Press the switch (1) to turn off the engine only in the event of a real Emergency.

When pressed in the “” position, it disables engine start-up and operation.

When pressed in the “” position, it enables the engine to run and start.

2.8.b Engine start button

By pressing the button (2) with the key in position “” and switch (1) in position “”, press a brake lever and the engine starts.

2.9 ACCELERATOR CONTROL

The throttle grip (1) is located on the right side of the handlebar.





2.10 FRONT BRAKE CONTROL

The brake lever (1) is located on the right side of the handlebar. A stop switch, when braking, causes the rear light lamp to come on. To apply the brake, pull the lever towards the throttle grip.

The position of the control on the handlebar can be adjusted by loosening the two fixing screws (2).

WARNING

Do not forget to tighten the screws (2) after adjustment.

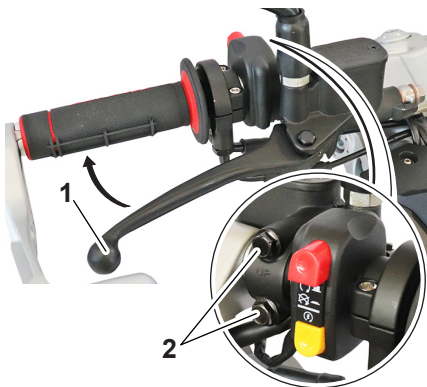

2.11 REAR BRAKE CONTROL

The brake lever (1) is located on the left side of the handlebar. A stop switch, when braking, causes the rear light lamp to come on.

To activate the brake, pull the lever towards the knob.

The position of the control on the handlebar can be adjusted by loosening the two fixing screws (2).

WARNING

Do not forget to tighten the screws (2) after adjustment.

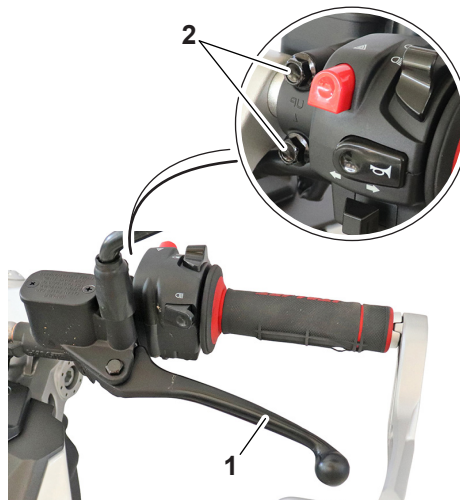



2.12 FUEL TANK

DANGER

Gasoline is extremely flammable and can become explosive under certain conditions. Always turn off the engine, do not smoke or approach flames or sparks in the area where you refuel or store fuel.

2.12.a Refueling

- Switch off the engine.
- Lift the lock cover (1).
- Insert the key (2) and turn it 1/4 turn in the direction of the arrow "A" to remove the cap (3).
- Pour the fuel into the tank.

WARNING

Do not fill the tank beyond the lower limit of the filler neck, if the fuel overflows, clean the fuel immediately with a rag as, in addition to being extremely flammable, it can deteriorate painted or plastic surfaces.

- Refit the cap (3) proceeding inversely to the removal operations, turning the key in the direction of arrow "B" then remove the key (2) and lower the lock protection cover (1).

NOTE: It is not possible to refit the fuel cap (3) without the key being inserted in the lock; it is possible to remove the key (2) from the cap (3) only if the latter is closed correctly.

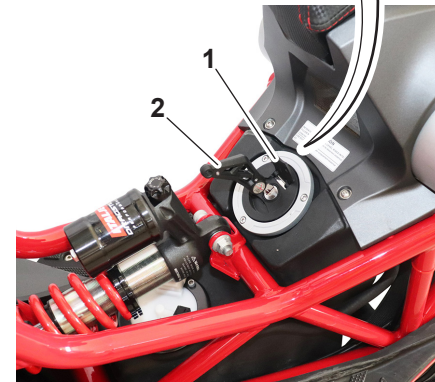
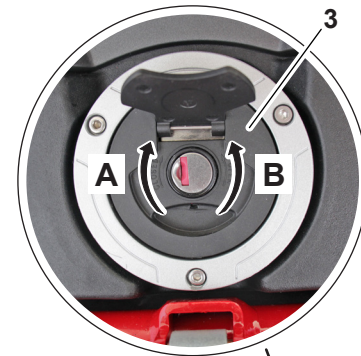



⚠ WARNING

Check that the fuel tank cap is closed properly after refueling. Fuel leaks constitute a fire risk.

2.13 FUEL

⚠ WARNING

Gasoline is poisonous and can cause injury or death. Handle gasoline carefully. Never suck up petrol with your mouth. If gasoline is ingested or if large quantities of gasoline vapors are inhaled, or gasoline encounters the eyes, seek immediate medical **WARNING**.

If you spill gasoline on your skin, wash it off with soap and water. If you spill petrol on your clothes, change them.

The engine was designed to use unleaded gasoline with a controlled octane number of 95 or higher. If the engine knocks, use a different brand or higher-octane gasoline.

Advised fuel:
Unleaded gasoline
(E10 acceptable)

Octane number (RON):
95

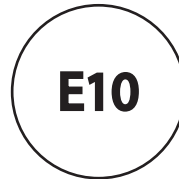
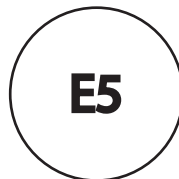

NOTE:

- This reference identifies the recommended fuel for this vehicle as specified by the European regulation (EN228).
- Check that the fuel pump nozzle has the same fuel identification reference.

2.13.a Different types of petrol

There are several types of gasoline containing ethanol. Gasoline containing ethanol can be used if the ethanol content does not exceed 10% (E10). *Italjet* does not recommend petrol containing methanol as it can cause damage to the fuel system, or vehicle performance problems.

WARNING

Use only unleaded petrol. The use of leaded petrol would cause serious damage both to the internal parts of the engine, such as valves and segments, and to the exhaust system.



2.13.b Catalytic converter

The exhaust system includes catalytic converters to reduce harmful exhaust emissions.

WARNING

The exhaust system reaches high temperatures after running the motorcycle. To prevent the risk of fire or burns:

- Do not park the vehicle near materials that can pose a fire hazard, such as grass or other easily combustible materials.
- Park the vehicle in a place where there is no danger of pedestrians or children touching the hot exhaust system.

- Check that the exhaust system has cooled down before carrying out maintenance work on it.
- Do not run the engine at idle even for a few minutes. A prolonged idle that can cause heat build-up.

2.14 ACCESSORY PARTS AND USB SOCKET

WARNING

The accessory connected to the USB socket should not be used with the engine off, and the load must never exceed 12W (1A), otherwise the fuse could burn out and the battery discharged.

2.14.a To use the USB socket

- Lift the guard (1).
- Connect the accessory to the socket (2).
- When the socket is not used, reposition the protection correctly.

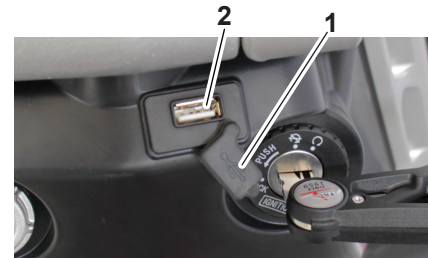



2.14.b Storage compartment under the saddle

- Place the motorcycle on the side stand or center stand.
- Insert the key (1) into the lock (2) and turn it until the seat lock is released.

- Lift the saddle (3) to access the compartment (4).
- To close the saddle, lower it and push down so that it hooks into the lock.

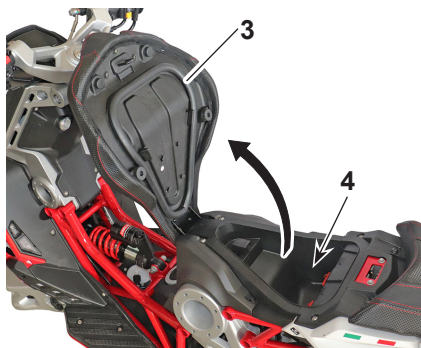
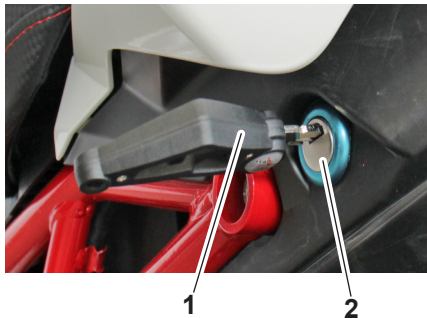

NOTE: After opening the compartment under the saddle, the key can be removed from the lock.





2.14.c Side stand

ATTENTION

The kickstand is designed to support the **WEIGHT OF THE MOTORCYCLE ONLY**.

Do not sit on the vehicle using the stand as a support; breakage could occur resulting in serious personal injury.

ATTENZIONE

The motorcycle **MUST** be placed on the side stand **ONLY AFTER** the rider has left the vehicle.

ATTENZIONE

A safety sensor is positioned on the motorcycle that does not allow the motorcycle to be started, with the stand down.

When the stand is lowered with the motorcycle running, the engine stops.

The side stand is located on the left side of the frame. Raise or lower the kickstand (1) with your foot while holding the vehicle upright.



DANGER

Do not use the motorcycle with the side stand down.

If the side stand does not remain raised, it is necessary to contact the nearest *Italjet* dealer for repair.

Periodically check the correct functioning of the side stand and the correct functioning of the safety sensor that blocks the starting of the motorcycle with the stand down.



2.14.d Central stand

- Grasp the left handlebar grip (1) and the left passenger handle (2).
- Press the lever (3) of the central stand (4) with your right foot and at the same time lift the motorcycle upwards and backwards until it is completely raised on the central stand.

ATTENTION

When the vehicle is parked on the central stand, it is dangerous to sit on board, thus placing one's weight on the parking support.

To lower the motorcycle from the central stand, proceed as described below.

- Grasp the left handle (1) and the left handle (2) of the passenger.
- Place your foot in front of the stand and push the motorcycle towards the front until it comes off the stand; the stand will rise automatically.





3.1 CHECKS BEFORE USE

Inspect the vehicle each time you use it to make sure it is in a safe condition to operate. Always observe the inspection and maintenance procedures and intervals described in the use and maintenance manual.

WARNING

Failure to perform a proper inspection or maintenance of the vehicle increases the possibility of accidents or damage to the vehicle. Do not use the vehicle if you experience problems. If the malfunction cannot be eliminated with the instructions provided in this manual, have the vehicle inspected by an *Italjet* dealer.

Before using this vehicle, please check the following points:

ELEMENT	CONTROLS
<i>Fuel</i>	<ul style="list-style-type: none"> - Check the fuel level in the fuel tank. - Refuel if necessary. - Check for leaks in the fuel circuit.
<i>Motor oil</i>	<ul style="list-style-type: none"> - Check the oil level in the engine. - If necessary, add oil of the recommended type up to the level. - Check for the absence of oil leaks from the engine.
<i>Final transmission oil</i>	<ul style="list-style-type: none"> - Check for the absence of oil leaks from the transmission.
<i>Coolant</i>	<ul style="list-style-type: none"> - Check the coolant level in the expansion tank. - If necessary, top up the coolant. - Check that there are no leaks in the cooling system.
<i>Wheels and tires</i>	<ul style="list-style-type: none"> - Check for damage. - Check the condition of the tires and the tread depth. - Check the air pressure.



ELEMENT	CONTROLS
Brakes	<ul style="list-style-type: none">- Check the operation of the brakes.- If you have a feeling of softness and pliability, have the safety system checked by an Italjet dealer.- Check the wear of the brake pads.- Replace them if necessary (for replacement, contact an Italjet dealer).- Check the fluid level in the tank, top up if necessary (to top up, contact an Italjet dealer).- Check that there are no leaks in the hydraulic system.
Side stand, center stand	<ul style="list-style-type: none">- Make sure the movement is smooth.- Lubricate the pivot points if necessary.
Instruments, lights, signals, and switches	<ul style="list-style-type: none">- Check the operation of the lights and direction indicators.
Side stand switch	<ul style="list-style-type: none">- Check the operation of the ignition circuit interruption system.- If the system does not work correctly, have the vehicle checked by an Italjet dealer.



3.2 INSTRUCTIONS FOR USING THE MOTOR-CYCLE

NOTE: *If you are not familiar with the operation of the motorcycle, before riding it, carefully read the instructions contained in the "CONTROLS" paragraph.*

3.2.a Break-in instructions

During the first 1000 km, the following rules must be **SCRUPULOUSLY** observed, the **NON-COMPLIANCE** of which **MAY JUDGE THE LIFE AND PERFORMANCE OF THE MOTORCYCLE:**

- Before using the vehicle, warm up the engine to a low number of revolutions.
- Avoid fast starts and do not run the engine at high revs.
- Drive at moderate speed until the engine warms up.
- Repeatedly use both brakes to run in the pads and discs.
- Avoid maintaining the same speed for a long time.
- Avoid traveling long distances without making stops.

3.2.b Identification of operating problems

The following list of any operating problems serves, in general, to identify their origin and implement the remedy.

The engine does not start

- Inadequate starting technique: follow the instructions in the paragraph "Starting the engine".
- Side stand lowered.

The engine is slow to start

- Dirty spark plug or in bad condition: replace

The engine starts but the operation is erratic

- Dirty spark plug or in bad condition: replace.

The spark plug gets dirty easily

- Inadequate spark plug, replace

The engine lacks power

- Dirty air filter: clean.

The brakes are not working properly

- Worn pads: replace at a specialized repair shop.

ATTENTION

For all other problems, contact an *Italjet* dealer.



3.3 RIDER AND PASSENGER GET ON / GET OFF THE BIKE

3.3.a General rules

Read the following instructions carefully as they provide important information for the safety of the rider and passenger to avoid damage to persons or damage to the motorcycle.

Getting on and off the motorcycle must always be done from the left side of the motorcycle, with your hands free, without hindrance and with the central stand raised.

If the side stand is present, the rider can climb up with the stand down.

The rider must be the first to get on and the last to get off the motorcycle and must govern the stability of the motorcycle during the passenger's ascent and descent.

Do not get off the vehicle by jumping or extending your leg, always get off by carrying out the operations described in the relevant paragraph.

3.3.b Rider Get On

Raise the central stand.
If there is a side stand, leave it in the lowered position.

- From the left side, hold the handlebar correctly with both hands, then lift the right leg and pass the saddle.
- Sit on the motorcycle and place both feet on the ground, straightening the vehicle without loading your weight on the side stand (if present).

WARNING

If you are unable to place both feet on the ground, place your right foot with your left foot ready for support.

- With the left foot, completely retract the side stand (if present).
- Start the motorcycle as described in the relative paragraph.

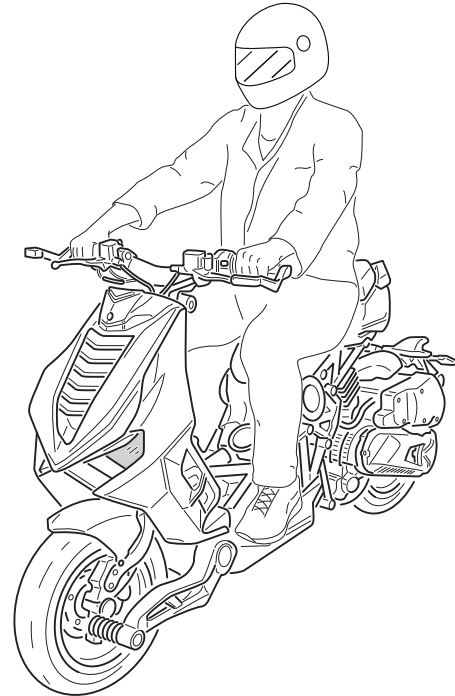



3.3.c Passenger Get On

- The rider must get on the motorcycle as described in the relevant paragraph, without starting the motorcycle.
- The passenger must extract the footrests (1).

WARNING

The rider in the driving position must not extract or try to extract the rear passenger footrests, as this could compromise the balance of the vehicle.

- Get on the bike by lifting your right leg, moving carefully so as not to unbalance the vehicle and the rider.

- With your hands hold on to the handles (2).
- With your left foot, retract the side stand (if present) completely.
- Start the motorcycle as described in the relative paragraph.

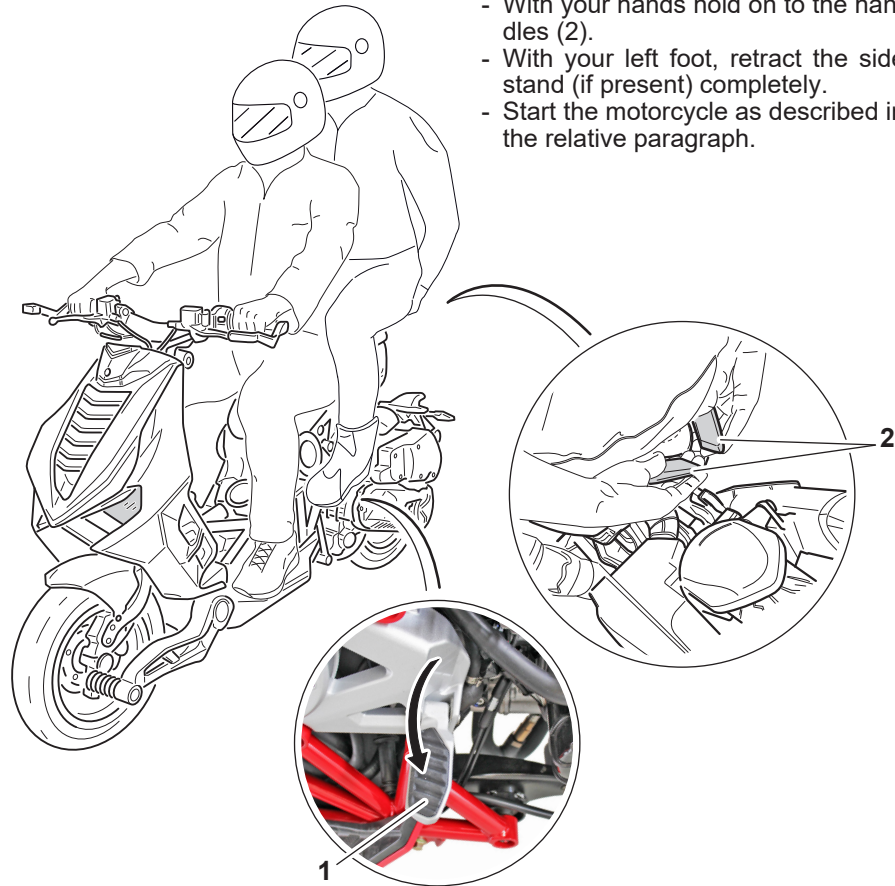



3.3.d Get Off the bike

- Stop the vehicle and switch off the engine.

! WARNING

Make sure that the area where the vehicle is to be parked is stable and level.

- Place both feet on the ground.
- Switch off the motorcycle as described in the relative paragraph.
- With your left foot, fully extract the side stand (if present).
- The passenger must get off the left side of the vehicle first by lifting his right leg.
- Tilt the motorcycle to the left until it rests on the side stand, if present.
- With your hands firmly on the handlebars, get off the bike on the left side by lifting your right leg.

3.4 REAR VIEW MIRRORS ADJUSTMENT

Sit on the motorcycle as described in the relative paragraph.
Adjust both mirrors (1) by moving them directly so that from a seated position the rider can see the rear of the road correctly.









4.1 STARTING OF THE MOTORCYCLE

After getting on the motorcycle, as indicated in the relevant paragraph, to start the engine proceed as follows:

NOTE: The motorcycle will not start if the side stand is down.

- Put the key (1) of the ignition switch in the “” position.



- The warning light “”, lights up for a few seconds and then goes off while the “”, “” lights remain on until the motorcycle is started.

- Make sure the throttle grip (2) is fully released and the kickstand is in the running position.
- Pull one of the two brake levers.
- Press the engine start button (3) and release it as soon as the engine starts.

NOTE: The “ABS” warning light remains on until the vehicle reaches a speed of 10 km / h (6mi / h) and then goes off.

NOTE: Do not run the cold engine at a high number of revolutions to allow the oil to heat and circulate in all points that need lubrication.





4.1.a Use of the accelerator

- Release the pulled brake lever and simultaneously rotate the throttle grip (1); speed is directly proportional to the rotation of the throttle grip, by turning the knob towards “A” the motorcycle accelerates, by turning the knob towards “D” the motorcycle decelerates.

4.1.b Using the brakes

To have a more incisive braking action, it is advisable to apply both brakes at the same time.

- Release the throttle grip (1) and pull both brake levers (2) gradually increasing the pressure according to the desired braking degree

WARNING

Avoid abrupt braking, be very careful when braking with the motorcycle on an incline, danger of falling. In some conditions, the independent use of the front or rear brake may be useful. Use the front brake carefully, especially on slippery ground. Incorrect use of the brakes can cause serious accidents.







4.1.c Stopping the motorcycle and engine

- Fully release the throttle grip (1) to decelerate the motorcycle.
- Brake both front and rear.
- Once the motorcycle has been stopped, turn the ignition key (2) to position “” (key removal position), the engine stops.



4.1.d Stopping the engine in an emergency

- To stop the engine in an emergency, press the red switch (1) on “”; after stopping the motorcycle, return the switch (1) back to the “” position.

WARNING

In the event of the accelerator locking in the open position or other malfunction that caused the engine to spin uncontrollably, **IMMEDIATELY** press the engine stop button (1). Maintain control of the motorcycle with normal use of the brakes and steering while pressing the stop button.



4.1.e Parking the motorcycle

Place the motorcycle on the side stand or on the central stand as described in the relative paragraphs.

WARNING

- **After turning off the motorcycle, the engine and the exhaust system can become very hot, try to park so that pedestrians do not accidentally touch these parts.**
- **Do not park next to dry grass or other flammable materials that can catch fire.**
- **Do not park on slopes or on soft ground; the motorcycle could overturn with possible fuel leakage and fire hazard.**



5.1 MAINTENANCE AND PERIODIC CHECKS

5.1.a Periodic maintenance

Periodic inspections, adjustments and lubrications keep the motorcycle in the best possible conditions of safety and efficiency. The most important points relating to motorcycle checks, adjustments and lubrication are illustrated on the following pages.

The maintenance intervals shown in the table should only be considered as a general guide under normal riding conditions. However, it may be necessary to reduce maintenance intervals depending on climatic conditions, terrain, geographical position, and individual use.

WARNING

Lack of maintenance or incorrect maintenance of the motorcycle can increase the risk of injury or death while using the vehicle. Have the maintenance carried out by an *Italjet* dealer or professional repairer.

WARNING

If you use the vehicle on dusty, muddy, or very wet roads, it is necessary to clean / replace the air filter with a shorter maintenance interval. Go to your *Italjet* dealer for the correct maintenance interval.

WARNING

Before carrying out any maintenance operation, check that you have the necessary tools, components, and technical skills.

- Switch off the engine and park the motorcycle on a flat and solid surface.
- Wait for the engine, silencer, and brake disks to cool down.



Interval of maintenance Items	<i>Time or mileage</i>											
	Time (Months)	6	12	18	24	30	36	42	48	54	60	66
	Mileage (km x 1000)	1	6	12	18	24	30	36	42	48	54	60
Engine												
Guided pulley roller			L		L		L		L		L	
Variator cover plastic bushing			R		R		R		R		R	
Clutch bell		C	C	C	C	C	C	C	C	C	C	C
Drive belt			R		R		R		R		R	
Transmission air filter			I		I		I		I		I	
Engine oil pre-filter screen	C	C	C	C	C	C	C	C	C	C	C	C
Engine oil filter	R	R	R	R	R	R	R	R	R	R	R	R
Valve clearance			A		A		A		A		A	
Hub oil	R		R		R		R		R		R	
Motor oil (*)	R	R	R	R	R	R	R	R	R	R	R	R
CVT rollers			R		R		R		R		R	
Front movable half-pulley CVT			I		I		I		I		I	
Transmission			L		L		L		L		L	
Spark Plug			R		R		R		R		R	
Air filter		C	C	C	C	C	C	C	C	C	C	C



Interval of maintenance	<i>Time or mileage</i>											
	Time (Months)	6	12	18	24	30	36	42	48	54	60	66
	Mileage (km x 1000)	1	6	12	18	24	30	36	42	48	54	60
Items												
Vaporization system												
Container and tubes	I		I		I		I		I		I	
Cooling system												
Coolant level (**)	I	I	I	I	I	I	I	I	I	I	I	I
Radiator			C		C		C		C		C	
Fuel Supply System												
Fuel filter			R		R		R		R		R	
Fuel pipes (***)	I		I		I		I		I		I	
Electrical system												
Battery voltage	I		I		I		I		I		I	
Headlight adjustment			A		A		A		A		A	
Road test of the vehicle												
Road test of the vehicle	I		I		I		I		I		I	



Interval of maintenance Items	<i>Time or mileage</i>											
	Time (Months)	6	12	18	24	30	36	42	48	54	60	66
	Mileage (km x 1000)	1	6	12	18	24	30	36	42	48	54	60
Frame												
Safety fixings	I		I		I		I		I		I	
Brakes	I	I	I	I	I	I	I	I	I	I	I	I
Brake fluid (**)	I		I		I		I		I		I	
Suspensions			I		I		I		I		I	
Wheels / tires	I	I	I	I	I	I	I	I	I	I	I	I
Steering	I		I		I		I		I		I	
Exhaust system			I		I		I		I		I	
Throttle control	A		A		A		A		A		A	

I: Check and clean, adjust, grease or replace if necessary

C: Clean

R: Replace

A: Adjust

L: Lubricate

(*) Check the level every 3000 km

(**) Replace every 2 years

(***) Replace every 4 years



5.1.b Check oil level

NOTE: The check must be carried out with the engine just switched off and still warm.

! WARNING

The motorcycle muffler reaches high temperatures, be careful not to get burned.

- Place the motorcycle on a level surface, in a vertical position raised on the central stand.
- Wait a few minutes to allow the oil to settle.
- Unscrew the dipstick (1) and remove it, clean the dipstick with a rag and insert it back into the filling hole (2) without screwing it in, then remove it and check that the oil level is between the minimum level marks "MIN" and maximum "MAX".
- In case of topping up, insert oil through the hole (2) up to the MAX level and not beyond.
- Reassemble the dipstick (1) by screwing it.

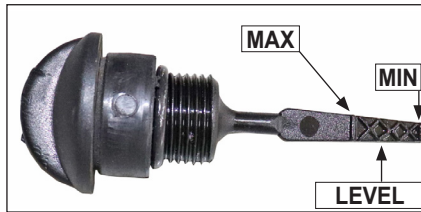

5.1.c Engine oil and filter replacement

NOTE: Oil replacement must be carried out with the engine just turned off and still warm.

! WARNING

Be careful not to burn yourself with hot oil.

- Place the motorcycle on a level surface, in a vertical position raised on the central stand.
- Remove the oil dipstick (1).

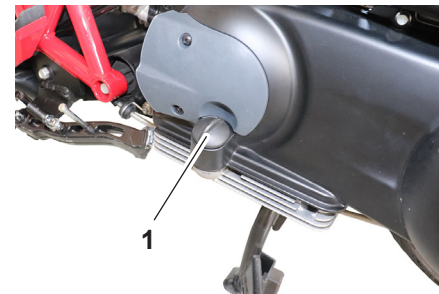



- Place a basin in correspondence with the drain plug (2).
- Unscrew the drain plug (2) and let all the oil drain.

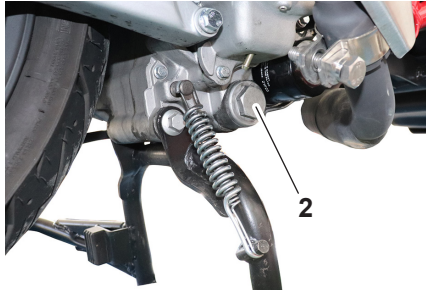

- Use the relevant tool (4) to unscrew the oil filter (5).

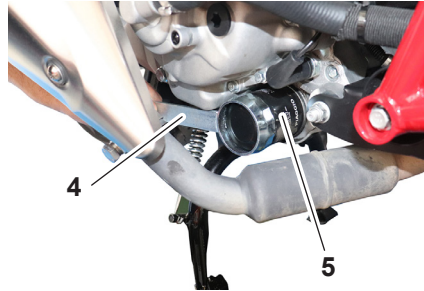

- Clean the filter (3), replace it if ruined and then re-mount it.

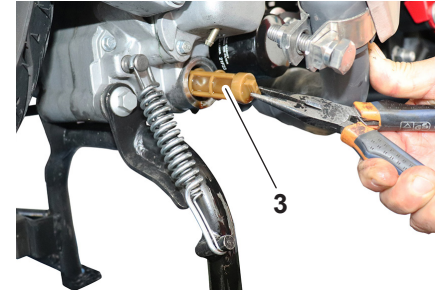

- Use pliers to remove the washable filter (3).

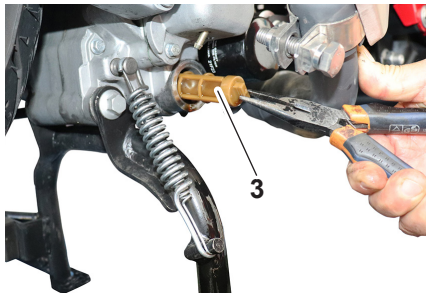

- Remove the filter (5).

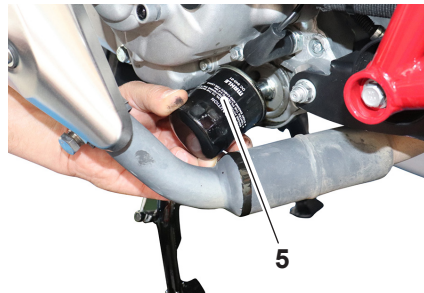

- Check the status of the gasket (6) on the cap (2), replace it if it is ruined.

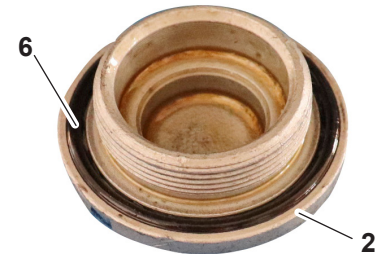



- Re-mount the cap (2), tightening it with a torque of 25 Nm / 18.44 ft/lb.

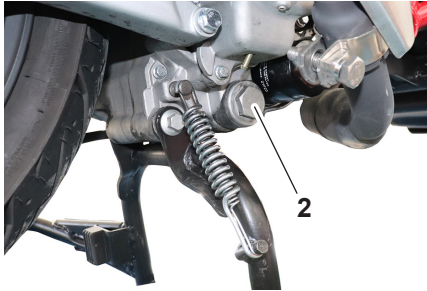

- Mount the filter (5) tightening it using the relevant tool (4) and with a coupling torque of 12 Nm / 8.85 ft/lb.

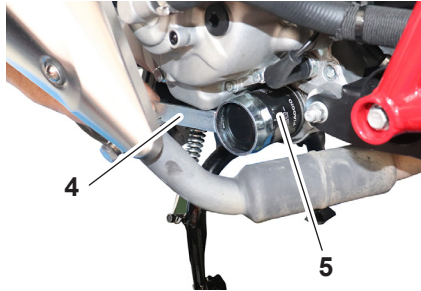

- Reassemble the dipstick (1) by screwing it.



NOTE: For the type of oil to use, see the "Refueling" paragraph.

NOTE: Clean any oil spilled on the parts with a rag after the engine and the exhaust system have cooled down.

- Lubricate the gasket (7) with oil.



- Pour approx. 1250 cm³ of oil into the oil tank through the hole (8).

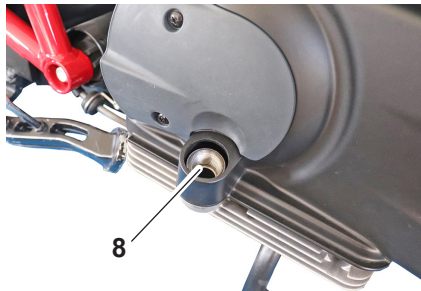

- Start the engine and let it idle for several minutes, checking that there are no oil leaks. If there is an oil leak, stop the engine immediately and look for the cause.
- Turn off the engine, check the oil level and correct it if necessary.
- Reset the maintenance interval as described in the "Digital instrument" paragraph.



5.1.d Check the coolant level

NOTE: Check the coolant level with a cold engine.

- Place the motorcycle on a level surface, in a vertical position raised on the central stand.
- Remove the cover (1) of the expansion tank (2).



- Check that the liquid level is between the minimum "MIN" level and the maximum "MAX" level of the tank.

- If it is necessary to top up, remove the tank cap (3) by unscrewing it and introduce the coolant from the hole (4) checking the level on the tank (2).
- Once the level has been restored, refit the cap (3) and the cover (1).

NOTE: The coolant is corrosive, if a little is spilled during topping up, carefully clean the parts that have been in contact with water.

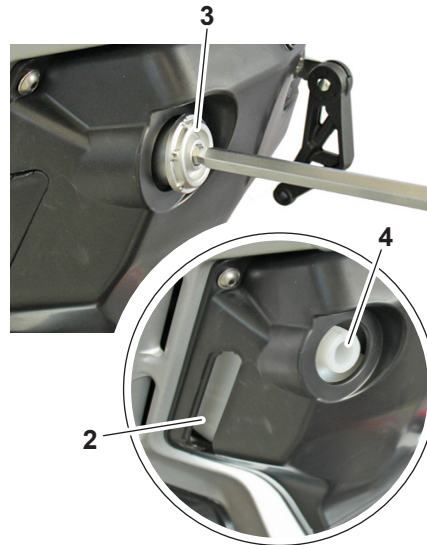

5.1.e Cleaning the engine air filter

- Unscrew the screws (1) and remove the cover (2).

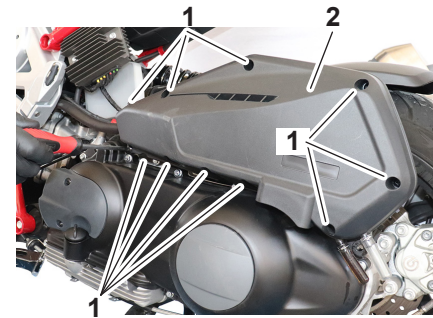

- Remove the filter (3) from the filter cover (2).

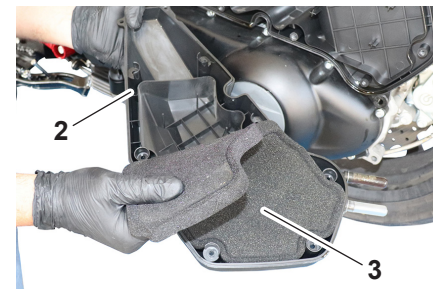



- Clean the filter (3) with suitable filter cleaner and let it dry completely.

⚠ WARNING

Do not use petrol or other flammable solvents to clean the filter.

- Check that the filter is not worn or damaged, replace it if necessary.
- Apply specific oil for filters on the entire surface of the filter (3) then squeeze it to remove excess oil.
- Re-mount the filter (3) on the lid (2).

- Check the condition of the gasket (4), replace if damaged.

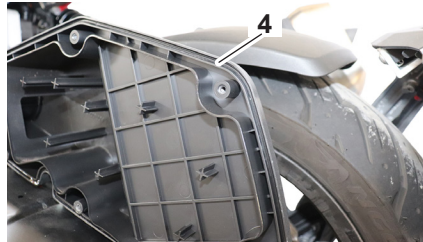

- Check that the vents (5) and (6) are not dirty, if you see any dirt, remove the vents, clean them, and reassemble them.



- Refit the filter cover (2) by tightening the screws (1).

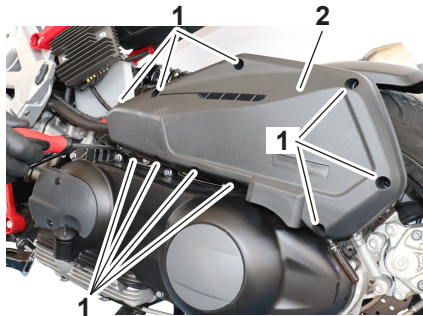
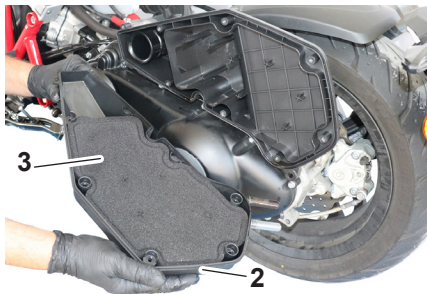



5.1.f Cleaning the transmission air filter

- Unscrew the screws (1) and remove the cover (2).

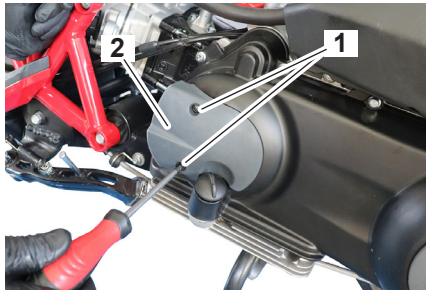

- Remove the filter (3) and clean it using relevant detergents.



⚠ WARNING

Do not use petrol or other flammable solvents to clean the filter.

- Check that the filter is not worn or damaged, replace it if necessary.
- Check the status of the gasket (4), replace it if it is ruined.

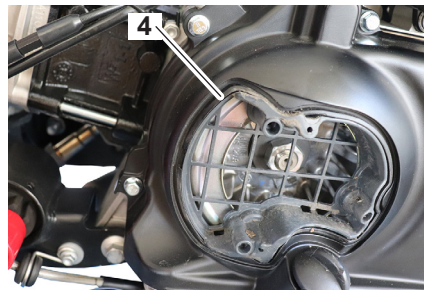

- Re-mount the filter (3) and the lid (2) in reverse order to disassembly.

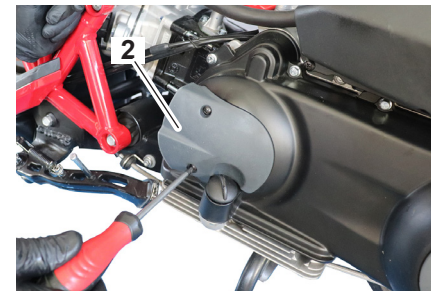



5.1.g Spark plug check

⚠ WARNING

Wait until the engine has cooled down before carrying out the check, danger of burns.

- Remove the cap (1).
- Using the appropriate key, remove the spark plug (2).

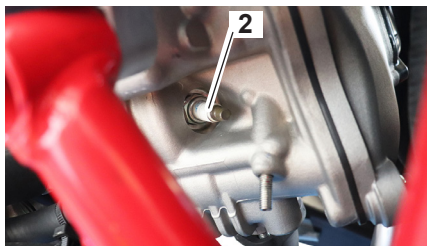

The distance between the spark plug electrodes (2) must be $0.5 \div 0.6$ mm. A different distance can cause the motorcycle to malfunction.

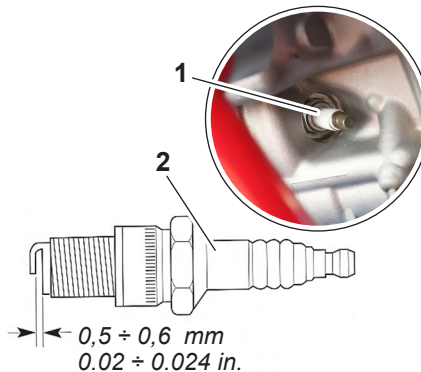

5.1.h Check tires and relative pressure

It is essential to always keep your tires in good condition and replace them at the proper intervals with tires according to specification.

Always check and, if necessary, adjust the tire pressure before setting off.

⚠ WARNING

Using the motorcycle with an incorrect tire pressure can cause serious injury or death as a result of loss of control.

- Check and adjust the tire pressure when cold (ie when the tire temperature equals the ambient temperature).
- The tire pressure must be adjusted according to the total weight of the rider, passenger, load and accessories approved for this model.



5.1.i Tire check

This motorcycle is equipped with tubeless tires.

- Check the condition of the tires, they must not have cracks, abrasions, etc., also check the wear of the tread using the special indicators on the tire itself.

MINIMUM HEIGHT OF THE TREAD

FRONT	2 mm (0.08 in)
REAR	2 mm (0.08 in)

- Check the pressure according to the indications given in the technical data paragraph.

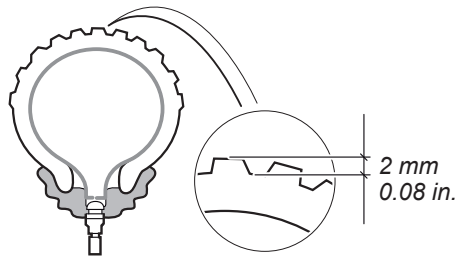

⚠ WARNING

The front and rear tires must be of the same make and model, using different types of tires between the front and rear wheels compromise the stability of the motorcycle and its maneuverability.

NOTE: Tires age even if they are not visually worn; lateral cracks or deformations of the casing are a sign of aging. Have the tires checked by a tire dealer before using the motorcycle.

Cold tire pressure:

1 person:

Front:
190 kPa (1.9 Kgf/cm², 28 psi)

Rear:
200 kPa (2.00 kgf/cm², 29 psi)

2 people:

Front:
210 kPa (2.10 kgf/cm², 30 psi)

Rear:
250 kPa (2.50 kgf/cm², 36 psi)

- To adjust the pressure, remove the cap (1) and connect the pressure gauge to the valve (2).

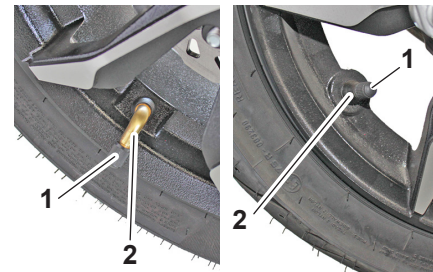



⚠ WARNING

- **Replace excessively worn tires by a tire dealer. Using the vehicle with excessively worn tires reduces driving stability and can cause loss of control of the vehicle.**
- **Ride at moderate speed after changing a tire, to allow the surface of the tire to “break in”, so that it can develop its characteristics to the fullest.**

NOTE: *When replacing a tire, it is necessary to balance the wheel.*

Before each use, always check the rims for cracks, bends, deformations, or other damage. If any damage is found, have the wheel replaced. Don't try to do even the slightest repair on a wheel. In case of deformation or cracks, the wheel must be replaced.

5.1.I Check the wear of the brake pads

Check the wear of the front brake pads (1) and rear brake pads (2).

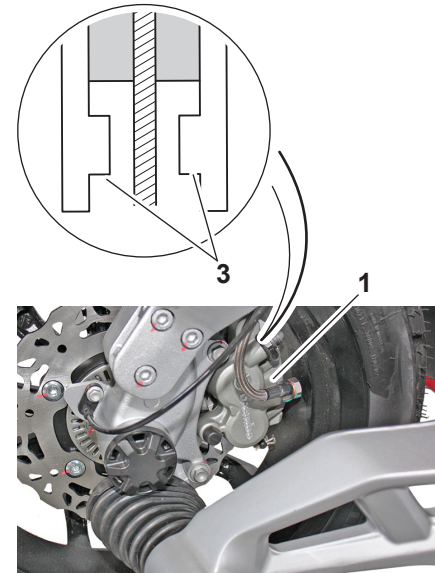



- The pads are equipped with a wear indicator (3). To check the pad wear, check the position of the wear indicator (3) while applying the brake. If a pad has worn to the point that the wear indicator almost touches the brake disc, replace the pads in pairs.

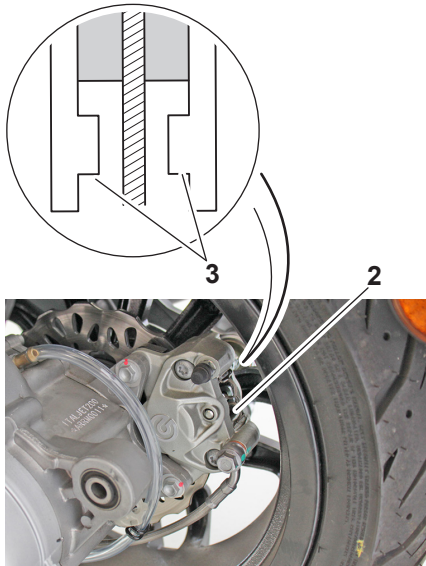

⚠ WARNING

To replace the brake pads, it is necessary to contact an *Italjet* dealer.

⚠ WARNING

After replacing the brake pads, it is necessary to drive carefully, braking gradually to allow the pads to settle correctly / couple with the relative discs.





5.1.m Front / rear brake fluid level check

- Position the motorcycle so that the upper part of the brake reservoir is parallel to the ground.
- The fluid level in the pump tank must be in the center of the rim (1).

Any lowering of the fluid level can allow air to enter the system with consequent lengthening of the stroke of the lever; if it is necessary to top up, contact your **Italjet** dealer.

WARNING

If the brake lever is too “soft”, there is air in the pipe or a system defect. As it is dangerous to ride the motorcycle in these conditions, have the braking system checked immediately by your *Italjet* dealer.

ATTENTION

Do not pour brake fluid on plastic parts and lenses (i.e. headlights)

WARNING

Do not mix two different types of fluid. If you choose to use a different brand of fluid, eliminate the existing one.

WARNING

Brake fluid can cause irritation. Avoid contact with skin and eyes. In case of contact, completely clean the affected area and, if it is the eyes, call a doctor.

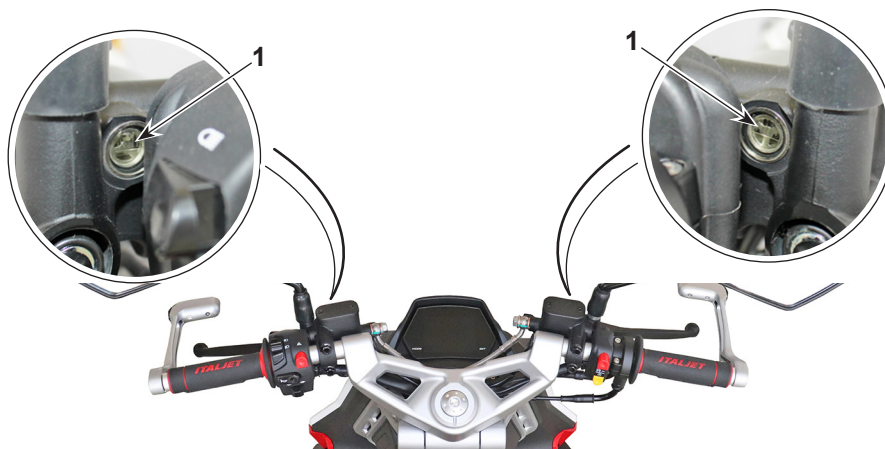



⚠ WARNING

- Use only the brake fluid prescribed according to specification; otherwise, the rubber seals may deteriorate, causing leaks.
- Top up with the same type of brake fluid. The addition of a brake fluid other than DOT 4 can cause a harmful chemical reaction.
- Avoid water or dust infiltration into the brake fluid reservoir during refueling. Water causes a significant reduction in the boiling point of the liquid and can cause “vapor lock”, and dirt can clog the valves of the ABS hydraulic unit.

WARNING

Brake fluid can damage painted surfaces or plastic parts. Always clean up any spilled liquid immediately.

As the brake pads wear out, it is normal for the brake fluid level to gradually go down. If the brake fluid level is low, it is possible that the brake pads are worn and / or that there is a leak in the brake circuit; therefore, be sure to check the wear level of the brake pads and the presence of leaks in the brake circuit.

If the brake fluid level drops suddenly, have the vehicle checked by an *Italjet* dealer before continuing to use it.

5.1.n Changing the brake fluid

Have an *Italjet* dealer change the brake fluid every 2 years. Also, have the seals of the master cylinders and brake calipers, as well as the brake hoses, replaced at the intervals listed below or sooner if they are damaged or leaking.

- Brake seals: every 2 years
- Brake hoses: every 4 years

5.1.o Checking the V-belt

The V-belt must be checked and / or replaced by an *Italjet* dealer at the intervals specified in the periodic maintenance chart.



5.1.p Checking and lubricating the center stand and side stand

Periodically, always check the operation of the central stand and side stand and lubricate the guide pins (1) and metal-to-metal contact surfaces if necessary.

⚠ WARNING

If the central stand or side stand does not raise or lower easily, have it checked or repaired by an *Italjet* dealer.

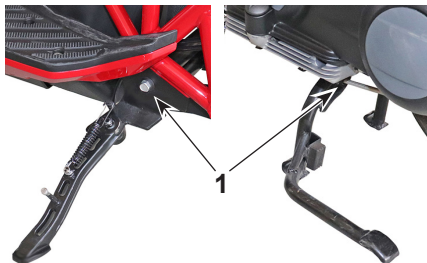

5.1.q Shock absorber spring preload adjustment

The front (1) and rear (2) shock absorbers can adjust the spring preload. To adjust, loosen the counter-ring nut (3) and operate on the ring nut (4); screwing it increases the preload, vice versa it decreases.

By screwing the ring nut, the spring is compressed and therefore a stiffer damping action is obtained.

Unscrewing the ring nut releases the spring and therefore you will have a softer shock absorbing action.

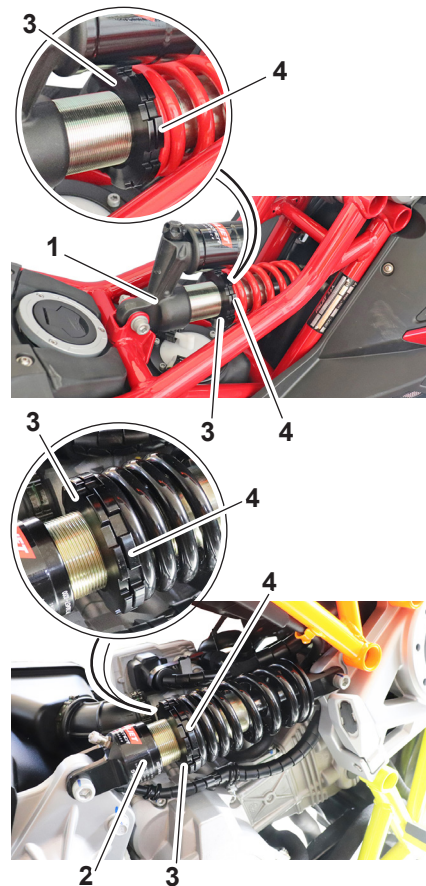



5.1.r Front shock absorber braking adjustment

- Adjust braking by operating on the lock-nut (1), by rotating it towards “+” braking increases, by rotating it towards “-” braking decreases.

Factory adjustment is 6 clicks from fully closed.

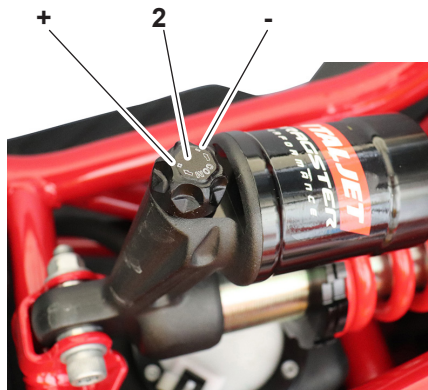

5.1.s Front steering column check

Periodically, any play in the steering column should be checked.

- Place the motorcycle on the central stand, one person must hold the motorcycle handlebar so that it is stable, and another person must try to move the wheel (1) in the direction of the arrow “A” and in the direction of the arrow “B”.

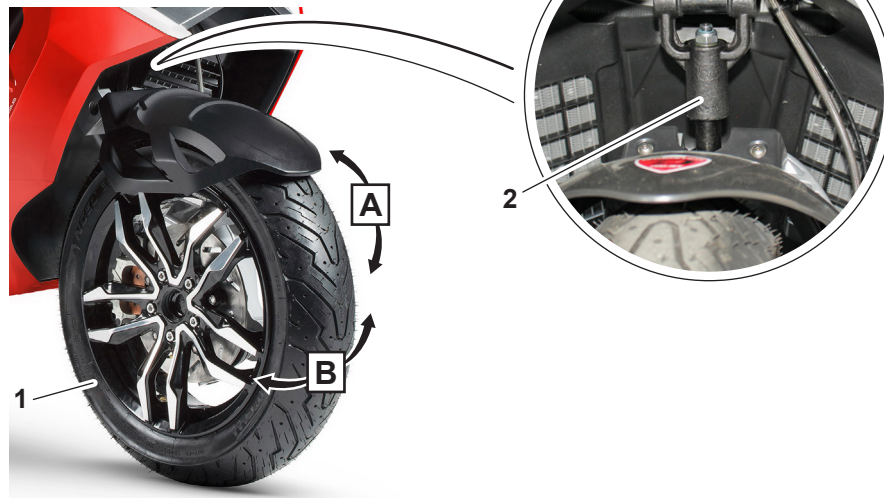

If excessive play is found, contact an **Italjet** dealer to check the steering movement (2).





5.1.t Checking and charging the battery

To access the battery compartment, proceed as follows:

- Lift the saddle as described in the relative paragraph.
- Unscrew the two screws (1) and remove the passenger seat (2).

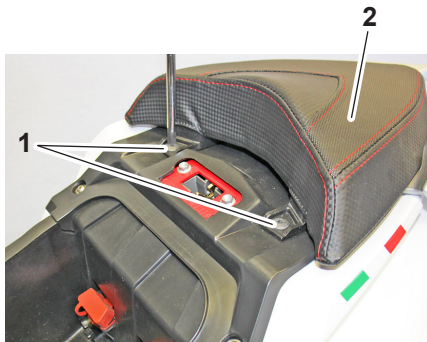

- Unscrew the two screws (3) and remove the casing (4).

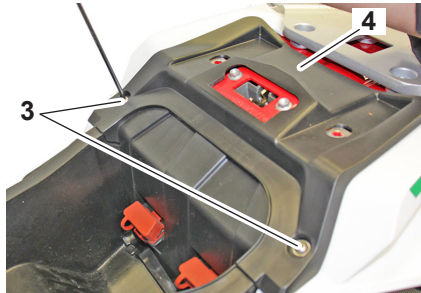

- First remove the BLACK negative cable (5) then the RED positive cable (6) (when reassembling, connect the RED positive cable first, then the BLACK negative one).
- Remove the battery (7) from its housing.

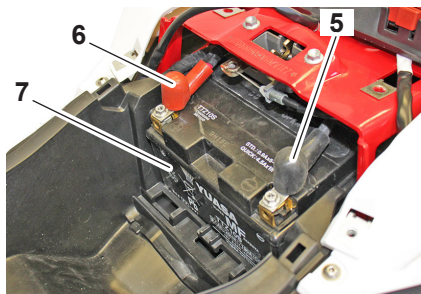

- Verify, with the help of a voltmeter, that the voltage of the same is not less than 12.5V. If not, the battery needs a recharge cycle.

- Using a constant voltage battery charger, first connect the RED positive cable to the positive terminal of the battery then the BLACK negative one to the negative terminal of the same.

- Always check the state of charge of the battery before reinstalling it on the vehicle. The battery must be kept clean, and the terminals greased.

>>>





- Reassemble everything by proceeding in the reverse order to disassembly, taking care to fit the hook (8) of the passenger seat into the seat (9) of the support.

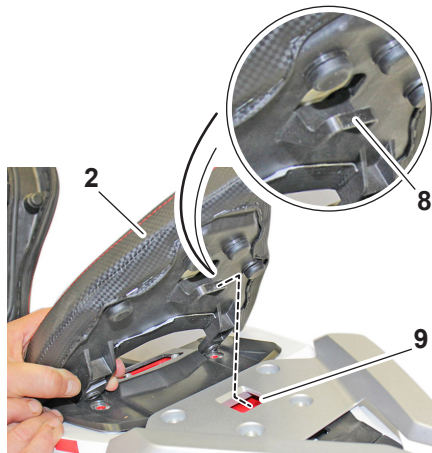

! DANGER

The battery contains sulfuric acid. Avoid contact with skin, eyes, and clothing.

REMEDIES:

CONTACT WITH THE SKIN

Rinse thoroughly with water.

INGESTION:

Drink large quantities of water and milk.

Call a doctor right away. Do not induce vomiting.

EYE CONTACT

Rinse with water for at least 15 minutes and call a doctor.

ATTENTION

If the battery is not in use, it must in any case be recharged with a slow charge cycle (0.6 A for 8 hours for 12V-6Ah battery) at least every 3 weeks.

! WARNING

Batteries produce explosive gases, ventilate the room when charging the battery indoors. When using a battery charger, connect the battery to the charger before turning it on. This practice avoids the formation of sparks at the battery terminals which could ignite the gases contained in the battery.





5.1.u Checking / replacing the fuses

The motorcycle is equipped with two fuse boxes, one located under the seat, and one located under the front panel.

Fuses under the seat

- Lift the saddle to access the fuse box (1).

Fuse 2 (20 A) = ABS motor

Fuse 3 (15 A) = ABS valve

Fuse 4 (10 A) = Positive, instrument panel, voltage regulator, injection

Fuse 5 (20 A) = Spare fuse

Fuse 6 (15 A) = Spare fuse

Fuses under the front panel

- Unscrew the screws (1) and remove the upper panel (2).

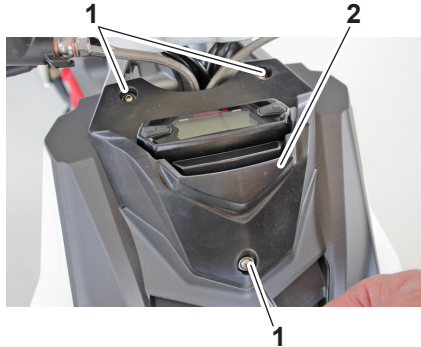

- Slightly pull the panel (3) outwards to release it from the top.

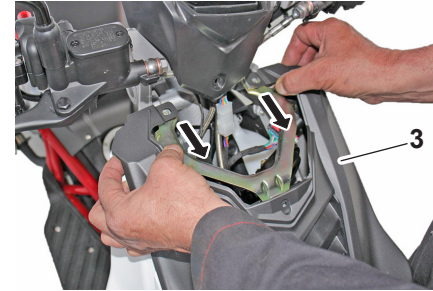

- Take the panel (3) with both hands and pull it outwards until it is released from the support.

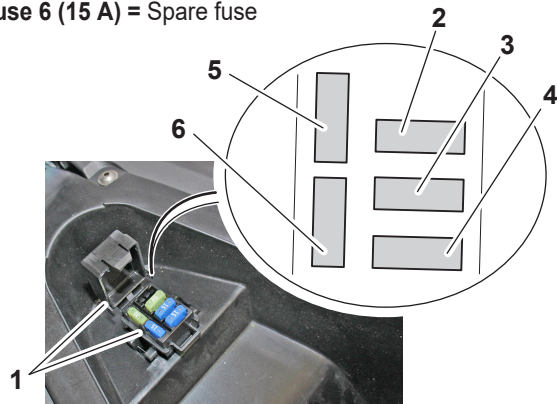
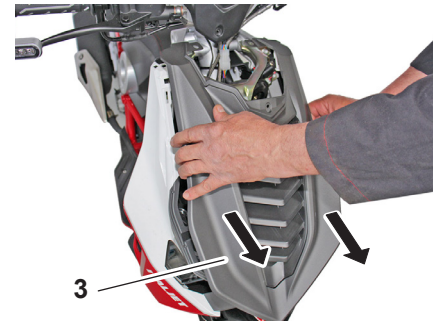



- The fuse box (4) is located in the upper right part of the motorcycle.

Fuse 5 (15A) = Lights, license plate light, direction indicator relay, horn

Fuse 6 (15A) = Injection, starter motor

Fuse 7 (15A) = Spare fuse

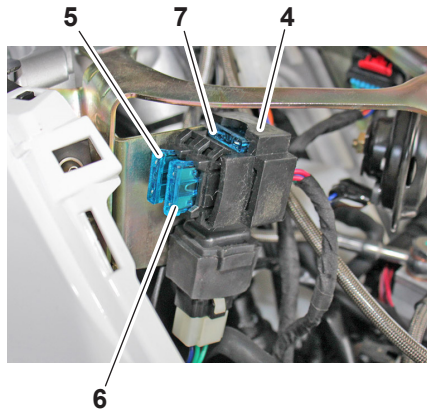

- Reassemble everything proceeding in the reverse order to disassembly, taking care to fit the stops (8) of the panel (3) in their seats (9).

ATTENTION

Do not use a fuse with a higher amperage than the original one, it could cause damage to the electrical system and possible fire.

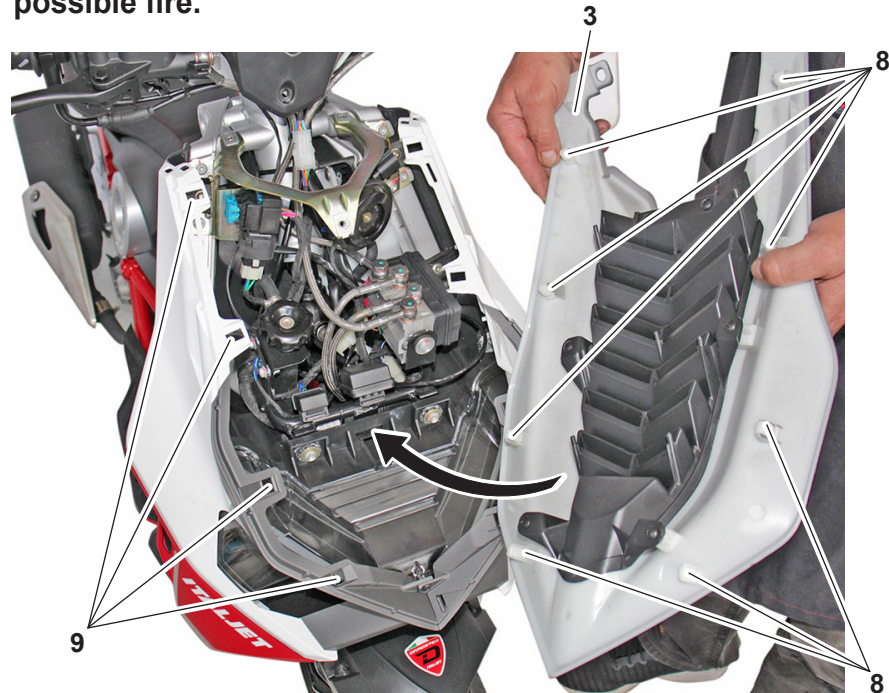



5.1.v Lighting control

Front light beam control

- To check if the light is oriented correctly, place the motorcycle, with the tires inflated to the right pressure and with a person sitting in the saddle, perfectly perpendicular to its longitudinal axis.
- In front of a wall or a screen, 10 meters away from it, draw a horizontal line corresponding to the height of the center of the light and a vertical line in line with the longitudinal axis of the vehicle.

- Carry out the check, if possible, in dim light.
- By turning on the high beam, the upper limit of demarcation between the dark area and the illuminated area must be at a height not exceeding 9/10 of the height from the ground of the center of the projector.
- To carry out the correct adjustment, go to an *Italjet* dealer.

Lights and direction indicators

- The motorcycle is equipped with LED lights and indicators, if a light does not work it must be replaced by going to the *Italjet* dealer.

Diagnostic connectors

Lift the saddle to access the Diagnostic Connectors (1)(2).

Connector (1) = ABS control unit

Connector (2) = Engine control unit

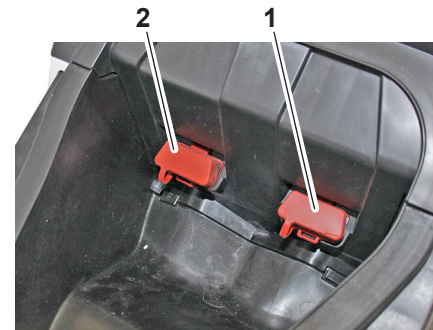
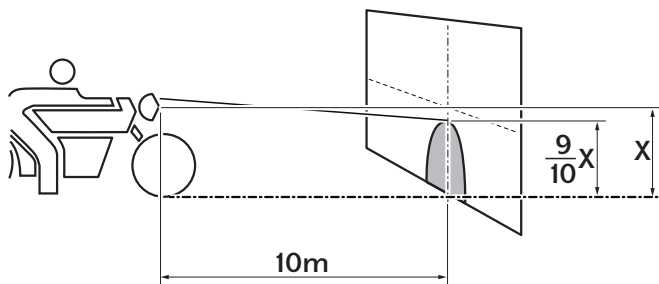



6.1 MOTORCYCLE CARE AND STORAGE

6.1.a Care

Frequent and thorough cleaning of the vehicle, in addition to improving its appearance, will also improve its overall performance and extend the useful life of many components. In addition, washing, cleaning and polishing will allow you to inspect the condition of the vehicle more frequently. Wash the vehicle after using it in the rain or near the sea, as the salt is corrosive to metals.

NOTE: Roads in areas prone to heavy snow can be sprinkled with salt to prevent them from freezing. This salt can remain on the roads until late spring, so wash the underside and chassis components after using the vehicle in such areas.

WARNING

Inadequate cleaning can cause aesthetic and mechanical damage. Do not use:

- High pressure cleaners or steam jet cleaners. Excessive water pressure could cause water penetration and deterioration of wheel bearings, brakes, transmission seals and electrical devices.
- Aggressive chemicals, abrasive cleaning agents or wax on components with a satin finish. Brushes can scratch and damage the satin finish; use only soft sponges or towels.

- Towels, sponges, or brushes contaminated with abrasive cleaning products or aggressive chemicals, such as solvents, petrol, rust inhibitors, brake fluid, antifreeze, etc.



6.1.b Washing

Before

1. Park the motorcycle out of direct sunlight and allow it to cool. This will prevent limescale stains from forming.
2. Check that all plugs, covers, connectors and electrical connection elements are properly installed.
3. Be careful not to let water penetrate inside the silencer.
4. Remove Road dirt and oil stains with a quality degreasing agent and a brush with plastic bristles or a sponge.

During

1. Rinse away any traces of degreaser using running water. Avoid spraying water directly into the muffler, on the instrument panel, in the air inlet or inside other internal areas, such as the storage compartments under the saddle.
2. Wash the motorcycle with a quality car cleaner mixed with fresh water and a soft sponge. Use a used toothbrush or a brush with plastic bristles to clean hard-to-reach places.

ATTENTION

If the motorcycle has been exposed to salt, use cold water. Hot water will increase the corrosive properties of the salt.

3. Rinse well with clean water. Remove all detergent residues; could be harmful to plastic components.

After

1. Dry the motorcycle completely.
2. Polish the chrome, aluminum and stainless-steel surfaces with a specific product.
3. Apply anti-corrosion spray to all metal components, including chrome or nickel-plated surfaces.

⚠ WARNING

Do not apply silicone or oil-based sprays to the saddles, grips, rubber footrest brackets, brake discs or tire treads. Otherwise, the components will become slippery, which could cause you to lose control of the vehicle. Thoroughly clean the surfaces of these components before using the vehicle.



4. Treat rubber, vinyl, and unpainted plastic components with a suitable care product.
5. Spread a non-abrasive wax on all painted surfaces.
6. After cleaning, start the engine and let it run at idle for a few minutes to dry the residual moisture.
7. Allow the vehicle to dry completely before storing or covering it.

WARNING

Foreign matter left on the brakes or tires can cause you to lose control of the vehicle.

- **Make sure there is no lubricant or wax on the brakes or tires.**
- **If necessary, wash the tires with warm water and a neutral detergent.**
- **If necessary, clean the brake discs and pads with a special spray cleaner.**
- **After washing the motorcycle, test the efficiency of the brakes.**

6.1.c Storage

Always store the vehicle in a cool, dry place. If necessary, protect it from dust by covering it with a permeable sheet.

Make sure that the engine and the exhaust system have cooled down before covering the motorcycle.

ATTENTION

To prevent corrosion, avoid damp basements, animal shelters (due to the presence of ammonia) and environments where strong chemicals are stored.



6.1.d Prolonged storage

Before storing the vehicle for an extended period (60 days or more) do the following:

1. Carry out maintenance work.
2. Clean the motorcycle.
3. Fill the fuel tank by adding fuel stabilizer according to the product instructions.
Run the engine for 5 minutes to distribute the treated fuel throughout the fuel system.
4. Lubricate the sidestand (if equipped) and the centerstand.
5. Check and restore the tire pressure and then raise the vehicle so that the wheels are off the ground.
6. Cover the drain with a plastic bag to prevent moisture from entering.
7. Remove the battery and fully charge it or connect a maintainer charger to maintain optimal battery charge.

ATTENTION

Check that the battery and its charger are compatible.

***NOTE:** If the battery will be removed, charge it once a month and store it in a temperate place where the temperature is 0-30 ° C (32-90 ° F).*



7.1 TECHNICAL DATA

Maximum length	1885 mm
Maximum width	750 mm
Max height	1075 mm
Seat height	760 mm
Wheelbase	1350 mm
Minimum height from the ground	120 mm
Curb weight (empty weight)	150 kg
Maximum vehicle load (driver + passenger + luggage)	305 kg
Full speed	124 km/h
Motor oil	1300 cm ³ (First filling) 1250 cm ³ (Replace engine oil & filter) 1200 cm ³ (Only change engine oil)
Transmission oil	250 cm ³
Refrigerant	1.15 l (50% water + 50% ethylene glycol antifreeze liquid)
Seats	2
Gear Box	CVT
Transmission	Speed reducer and belt
Frame type	High resistance tubular steel frame, single front beam, double rear overlapping cradle.
Steering angle	27.5°

>>>>>





Front suspension	Independent Steering System
Front suspension travel	33 mm
Rear suspension	Mono Shock Absorber
Rear suspension travel	47 mm
Front disk	Ø 200 mm disc brake with hydraulic transmission
Rear disk	Ø 220 mm disc brake with hydraulic transmission
Wheel rims	Light alloy rims
Front wheel rim	MT 3.50 x 12"
Rear wheel rim	MT 4.00 x 13"
Type of tire	Without inner tube (Tubeless)
Front tire	120/70 - 12" 51 P (120/70-12 M/C, 58S)
Rear tire	140/60-13" M/C 63P (140/60-13 M/C 63S)
Standard front tire inflation pressure	190 kPa (1.9 bar)
Standard rear tire inflation pressure	200 kPa (2.0 bar)
Standard front tire inflation pressure with passenger	210 kPa (2.1 bar)
Standard rear tire inflation pressure with passenger	250 kPa (2.5 bar)
Battery	12V - 8.6Ah
Fuses	20 - 15 - 15 - 15 - 15 - 10 A
Alternator (permanent magnet type)	12 V - 300W a 8000 rpm



Engine technical data (300CC)

Model engine	AZC
Engine type	Liquid-cooled 4-stroke single cylinder, 4 valves per cylinder with single overhead camshaft
Net power max.	17 kW (8000 r/min)
Max.torque	23 N•m (6000 r/min)
Displacement	278 cc
Bore / stroke	75 mm x 63 mm
Compression ratio	11 : 1
Starting	Electric
Idle	1700 ± 170 rpm
Clutch	Automatic centrifugal dry clutch
Gear Box	Automatic
Cooling	Liquid cooling system with radiator and electric fan
Injection	Electronic injection
Throttle body diffuser	Ø 32 mm
Fuel	Super unleaded petrol, minimum octane number of 95 (NORM)
Ignition type	Electronic
Spark plug	NGK CR8EKB



8.1 PRODUCTS TABLE RECOMMENDED

Product	Description	Characteristics
Semi-synthetic or synthetic engine oil	Motor oil	SAE 5W-40 JASO MA, MA2 API SL ACEA A3
Semi-synthetic or synthetic engine oil	Gear oil	SAE 80W/90 75W/90 GL-4 / GL-5
L-XCDBB2 lubricant	Lithium grease with molybdenum for bearings and other points that require lubrication	NLGI 2
Brake Fluid DOT4	Brake fluid	FMVSS DOT4
Engine Coolant FD-2B	O.A.T. technology refrigerant	Anti-freeze protection down to -40 ° C. Complies with the CUNA 956-16 standard.
Lubricant / Engine oil 5W-30	Air filter sponge oil	-
NEUTRAL OR PETROLATED GREASE	Battery poles	-



EN - 70





9.1 GUARANTEE AND SERVICE BOOK





9.1.a The content of the guarantee

Your new motorcycle is guaranteed free from original defects in accordance with **Directive 99/44 EC**.

The guarantee consists in the free replacement or repair of the vehicle or of components that show, within the term, manufacturing defects or, in any case, defects pre-existing upon delivery of the vehicle.

The warranty is only valid if your vehicle has followed the recommended maintenance schedule and all coupons have been properly stamped.

We remind you that the warranty does not apply in the case of use of the vehicle in motorcycle competitions, as it is a different use and not compatible with the use for which your vehicle was specifically designed.

Remember that, as required by law, this guarantee is provided directly by your **Italjet** Dealer, to whom we invite you to contact for any need.

If your **Italjet** Dealer cannot satisfy your requests within a reasonable time or this is more convenient for you, we invite you to contact any other **Italjet** Dealer, who will be happy to be at your service.

9.1.b Battery activation

Your vehicle is covered by a guarantee against original defects from the moment it is delivered to you by your **Italjet** Dealer.

When you receive your **Italjet** vehicle, we invite you to sign, together with the Dealer, the Vehicle Delivery Certificate found in this manual.

9.1.c What to do in the event of a warranty claim

If, during the warranty period, your vehicle requires an extraordinary repair and / or replacement due to an original defect, we advise you to immediately contact the Dealer where you purchased the vehicle (your Dealer) describing it the problem occurred and having him examine the vehicle.

If the intervention is made necessary by the occurrence of an original defect, your Dealer will carry out the necessary repair or replacement free of charge in the shortest possible time.

9.1.d Warranty conditions

Exclusions

The following are excluded from the guarantee:

- Deterioration resulting from failure to comply with the periodic maintenance plan prescribed by **Italjet**.
- Vehicles whose repairs have been carried out with spare parts that do not conform to the original.
- Vehicles for which the periodic maintenance plan has not been carried out or for which the coupons have not been duly stamped.
- Vehicles used for racing / rental / heavy off-road use.

Consumables and wear parts:

The warranty does not cover normal wear and tear caused using the vehicle for the following parts:

- Spark plugs.
- Distribution chain.
- Brake pads and disks.
- Clutch disks and masses.
- Tires.
- Lamps and fuses.
- Transmission and control cables.
- Tubes and all other rubber parts.
- Bearings.
- Air and petrol filter.
- Secondary belt and gear drive.



Lubricants

The warranty does not cover liquids: oil, grease, battery acid and coolant.

Limitations

For all vehicles: the warranty of the BATTERY, the SEAT and the PLASTICS is limited to 6 months.

- The warranty does not cover maintenance and overhaul costs, nor the cost of the parts required for these operations.
- The guarantee does not cover the costs resulting from the guaranteed application such as: additional costs for communications, any room and board, or other derived costs such as compensation for lost time, commercial losses, replacement vehicle rental costs, transport.

NOTE: important for the validity of the guarantee:

- The warranty booklet must be kept with care and must be presented to the official **Italjet** dealer at each intervention.
- The inspection coupons must be completed by the Dealer who carried out the intervention.
- The guarantee can be transferred to subsequent owners until it expires.
- In case of change of ownership, use the special coupon found in this booklet.
- The manufacturer reserves the right to make changes and / or improvements on all its models without the obligation to make these changes on vehicles already in circulation.





DELIVERY CERTIFICATE

Date:

NB° Frame:

Model:

NB° Engine:

The motorcycle has been prepared for delivery by carrying out all the checks and pre-delivery operations provided for by ITALJET S.P.A. and completed with any optional accessories requested by the Customer.

The Customer has been given this Warranty Booklet and the Use and Maintenance Manual and the main driving devices supplied with the vehicle have been illustrated.

Dealer's stamp and signature

The official sales organization and the ITALJET SPA company declare that the processing of the buyer's personal data, with reference to Law No. 675 of 1996 and subsequent amendments, can also take place without the need for the Customer's consent, in implementation of the obligation to provide the Assistance Service.



CLIENT

Name: _____

Surname: _____

Address: _____

City: _____

Postal Code: _____

Phone number: _____

I declare to receive today the motorcycle indicated above complete and in accordance with my expectations, as well as I declare to receive this Warranty Booklet and the Use and Maintenance Manual. I authorize ITALJET S.P.A. to the processing of my personal data for the purpose of providing the Assistance Service pursuant to Law 675/1996 and subsequent amendments.

Customer signature

Copy for ITALJET S.P.A.



Area with horizontal dotted lines for text entry.



EN - 76





COMMUNICATION OF TRANSFER OF OWNERSHIP

Date: Km:

NB° Frame:

Model:

NB° Engine:

The undersigned: _____

Name: _____

Surname: _____

Address: _____

City: _____ Postal code: _____

Phone number: _____

Send in sealed envelope to:
ITALJET S.P.A. , Via dell'agricoltura, 2 - 40023 Castel Guelfo di Bologna (BO) - Italia

The official sales organization and the ITALJET SPA company declare that the processing of the buyer's personal data, with reference to Law No. 675 of 1996 and subsequent amendments, can also take place without the need for the Customer's consent, in implementation of the obligation to provide the Assistance Service.



CLIENT



Notify ITALJET S.P.A. who today transferred ownership of the aforementioned vehicle to Mr:

Name: _____

Surname: _____

Address: _____

City: _____

Postal code: _____

Phone number: _____

delivering this Warranty Booklet and the Use and Maintenance Manual supplied.

Copy for ITALJET S.P.A.





A series of 12 horizontal dotted lines, evenly spaced, intended for text entry.





Space for storing the tax documentation proving the execution of the scheduled maintenance coupons.



COUPON	<input type="text"/>	DATE	<input type="text"/>	Km	<input type="text"/>	Customer signature	<input type="text"/>	Dealer stamp	<input type="text"/>
COUPON	<input type="text"/>	DATE	<input type="text"/>	Km	<input type="text"/>	Customer signature	<input type="text"/>	Dealer stamp	<input type="text"/>
COUPON	<input type="text"/>	DATE	<input type="text"/>	Km	<input type="text"/>	Customer signature	<input type="text"/>	Dealer stamp	<input type="text"/>
COUPON	<input type="text"/>	DATE	<input type="text"/>	Km	<input type="text"/>	Customer signature	<input type="text"/>	Dealer stamp	<input type="text"/>
COUPON	<input type="text"/>	DATE	<input type="text"/>	Km	<input type="text"/>	Customer signature	<input type="text"/>	Dealer stamp	<input type="text"/>
COUPON	<input type="text"/>	DATE	<input type="text"/>	Km	<input type="text"/>	Customer signature	<input type="text"/>	Dealer stamp	<input type="text"/>
COUPON	<input type="text"/>	DATE	<input type="text"/>	Km	<input type="text"/>	Customer signature	<input type="text"/>	Dealer stamp	<input type="text"/>
COUPON	<input type="text"/>	DATE	<input type="text"/>	Km	<input type="text"/>	Customer signature	<input type="text"/>	Dealer stamp	<input type="text"/>
COUPON	<input type="text"/>	DATE	<input type="text"/>	Km	<input type="text"/>	Customer signature	<input type="text"/>	Dealer stamp	<input type="text"/>
COUPON	<input type="text"/>	DATE	<input type="text"/>	Km	<input type="text"/>	Customer signature	<input type="text"/>	Dealer stamp	<input type="text"/>

FIX with a paper clip or a stapler the Fiscal Receipt or Receipt that certifies that the maintenance coupons have been carried out.







FR

FRANÇAIS

Italjet décline toute responsabilité pour les erreurs qui auraient pu se produire lors de la rédaction de ce manuel et se réserve le droit d'apporter les modifications requises par le développement évolutif de ses produits. Les illustrations présentées sont indicatives et peuvent ne pas correspondre exactement au traité en question. La reproduction même partielle de cette publication est interdite sans autorisation écrite.





DRAGSTER

A large, stylized red letter 'D' logo. The 'D' is composed of a thick red horizontal bar on the left that curves into a vertical bar on the right. Inside the vertical bar, there is a smaller, white-outlined 'D' shape.

FR - 2





INDICE

1.1 PRÉSENTATION	FR - 5	2.5 RÉGLAGES ET AJUSTEMENTS DE L’AFFICHAGE	FR - 18	2.14 ACCESSOIRES POUR PRISE USB	FR - 26
1.2 AVERTISSEMENTS IMPORTANTS	FR - 5	2.6 COMMANDES	FR - 19	2.14.a Pour utiliser la prise USB	FR - 26
1.3 SYMBOLES PRÉSENTS DANS LE MANUEL	FR - 6	2.6.a Serrure à clé	FR - 19	2.14.b Compartiment de rangement sous la selle	FR - 27
1.4 CONDUITE SÉCURISÉE ET SÉCURITÉ À MOTO	FR - 7	2.6.b “Lock” antivol (verrouillage)	FR - 20	2.14.c Béquille latérale	FR - 28
1.5 SYSTÈME DE FREINAGE ANTIBLOCAGE – ABS	FR - 8	2.7 BLOC DE COMMANDE GAUCHE	FR - 21	2.14.d Béquille centrale	FR - 29
1.6 RISQUES LIÉS AU MONOXYDE DE CARBONE	FR - 8	2.8 BLOC DE COMMANDE DROIT	FR - 22	3.1 CONTRÔLES AVANT UTILISATION	FR - 30
1.7 INFORMATIONS DE SÉCURITÉ	FR - 9	2.8.a Bouton d’arrêt d’URGENCE	FR - 22	3.2 INSTRUCTIONS D’UTILISATION DU MOTOCYCLE	FR - 32
1.7.a Accessoires	FR - 9	2.8.b Bouton de démarrage du moteur	FR - 22	3.2.a Instructions de rodage ...	FR - 32
1.7.b Transport du scooter	FR - 9	2.9 COMMANDE DE L’ACCÉLÉRATEUR	FR - 22	3.2.b Identification des problèmes de fonctionnement	FR - 32
1.7.c Clé pliable	FR - 9	2.10 COMMANDE DE FREIN AVANT	FR - 23	3.3 MONTÉE / DESCENTE PILOTE ET PASSAGER	FR - 33
2.1 COMPOSANTS DU SCOOTER	FR - 10	2.11 COMMANDE DE FREIN ARRIÈRE	FR - 23	3.3.a Règles générales	FR - 33
2.2 COMMANDES ET INSTRUMENTS	FR - 13	2.12 RÉSERVOIR DE CARBURANT	FR - 24	3.3.b Montée du pilote	FR - 33
2.3 DONNÉES D’IDENTIFICATION	FR - 14	2.12.a Ravitaillement	FR - 24	3.3.c Montée du passager	FR - 34
2.4 INSTRUMENTATION	FR - 15	2.13 CARBURANT	FR - 25	3.3.d Descente de la moto	FR - 35
2.4.a Indicateurs et voyants d’avertissement	FR - 15	2.13.a Différents types d’essence	FR - 25	3.4 RÉGLAGE DES RÉTROVISEURS	FR - 35
2.4.b Instrumentation numérique	FR - 17	2.13.b Pot catalytique	FR - 26		





4.1 DÉMARRAGE DE LA MOTO FR - 36

- 4.1.a Utilisation de l'accélérateur FR - 37
- 4.1.b Utilisation des freins FR - 37
- 4.1.c Arrêt de la moto et du moteur FR - 38
- 4.1.d Arrêt du moteur en cas d'urgence FR - 38
- 4.1.e Stationnement de la moto FR - 38

5.1 ENTRETIEN ET CONTRÔLES PÉRIODIQUES FR - 39

- 5.1.a Entretien périodique FR - 39
- 5.1.b Contrôle du niveau d'huile FR - 43
- 5.1.c Remplacement de l'huile moteur et du filtre FR - 43
- 5.1.d Contrôle du niveau de liquide de refroidissement FR - 46
- 5.1.e Nettoyage du filtre à air du moteur FR - 46
- 5.1.f Nettoyage du filtre à air de transmission FR - 48
- 5.1.g Contrôle des bougies FR - 49
- 5.1.h Vérification des pneus et de la pression relative ... FR - 49

- 5.1.i Contrôle des pneus FR - 50
- 5.1.l Contrôle de l'usure des plaquettes de frein FR - 51
- 5.1.m Contrôle du niveau de liquide de frein avant/arrière FR - 53
- 5.1.n Vidange du liquide de frein FR - 54
- 5.1.o Contrôle de la courroie trapézoïdale FR - 54
- 5.1.p Contrôle et graissage de la béquille centrale et latérale FR - 55
- 5.1.q Réglage de la précharge du ressort des amortisseurs FR - 55
- 5.1.r Réglage freinage amortisseur avant FR - 56
- 5.1.s Vérification colonne de direction avant FR - 56
- 5.1.t Vérification et charge batterie FR - 57
- 5.1.u Contrôle / remplacement des fusibles FR - 59
- 5.1.v Commande d'éclairage FR - 61

6.1 ENTRETIEN ET STOCKAGE

DE LA MOTO FR - 62

- 6.1.a Soins FR - 62
- 6.1.b Lavage FR - 63
- 6.1.c Stockage FR - 64
- 6.1.d Stockage prolongé FR - 65

7.1 DONNÉES TECHNIQUES FR - 66

8.1 TABLEAU DES PRODUITS RECOMMANDÉS FR - 69

9.1 CARNET DE GARANTIE ET DE SERVICE FR - 71

- 9.1.a Le contenu de la garantie FR - 72
- 9.1.b Activation de la garantie FR - 72
- 9.1.c Que faire en cas de réclamation sous garantie FR - 72
- 9.1.d Conditions de garantie FR - 72





1.1 PRÉSENTATION

Bienvenue dans la famille des motos **Italjet!**

Votre scooter **Italjet** a été conçu et construit pour être le meilleur de sa catégorie. Les instructions de ce manuel ont été préparées pour fournir un guide simple et clair pour l'utilisation et l'entretien de la moto. Pour en tirer les meilleures performances, nous vous recommandons de suivre attentivement les instructions de ce manuel. Il contient des instructions pour effectuer les opérations de maintenance nécessaires. Les réparations ou entretiens plus spécifiques ou majeurs nécessitent le travail de mécaniciens experts et l'utilisation d'équipements appropriés. Il est conseillé de contacter le Réseau Officiel **Italjet** qui dispose de tous les outils pour offrir le meilleur service au Client.

ATTENTION

Rappelons enfin que le « **Manuel d'utilisation et d'entretien** » doit être considéré **comme faisant partie intégrante de la moto et à ce titre y rester attaché même en cas de revente.**

Cette moto utilise des composants conçus et fabriqués à l'aide de systèmes et de technologies de pointe.

Pour le bon fonctionnement de la moto, il est nécessaire de suivre le tableau d'inspection et d'entretien de ce manuel.



1.2 AVERTISSEMENTS IMPORTANTS

Les modèles **DRAGSTER** sont des motos à usage ROUTE, couvertes par une garantie contractuelle, sous réserve que LA CONFIGURATION STANDARD SOIT MAINTENUE et que les interventions d'entretien soient respectées.



1.3 SYMBOLES PRÉSENTS DANS LE MANUEL

Les informations particulièrement importantes sont mises en évidence par les symboles suivants.

 DANGER	DANGER est utilisé pour attirer l'attention sur les risques de blessures. Respectez tous les messages de sécurité qui suivent ce symbole pour éviter des blessures ou la mort.
 AVERTISSEMENT	AVERTISSEMENT indique une situation dangereuse qui, si elle n'est pas évitée, peut entraîner la mort ou des blessures graves.
ATTENTION	ATTENTION indique des précautions particulières à prendre pour éviter d'endommager le véhicule.
REMARQUE	<i>NOTER : contient des informations importantes sur le sujet.</i>



1.4 CONDUITE SÉCURISÉE ET SÉCURITÉ À MOTO

Ci-dessous, nous énumérons quelques principes de base pour une conduite sûre de votre scooter.

- N'oubliez pas que votre sécurité et celle du passager passent avant tout. Arriver en toute sécurité à la fin du voyage doit être l'objectif principal.
- Le pilote et le passager doivent porter des vêtements de protection adaptés tels que combinaison, gants, chaussures, casque homologué pour l'usage moto.
- La position du pilote doit être telle qu'il ait la vue la plus large possible sur la route sur laquelle vous roulez.
- Conduisez la moto prudemment, réglez la vitesse en fonction du trafic et du type de conformation de la route. Une conduite en douceur vous permet d'évaluer les dangers et de définir les trajectoires de virage avec plus de précision.
- Soyez toujours attentif aux panneaux d'avertissement et modulez la vitesse en fonction des indications données.
- Respectez toujours les limitations de vitesse.
- Toujours évaluer l'état de la chaus-

sée et moduler la vitesse en fonction de celui-ci.

- Limitez votre vitesse en cas de pluie et surtout en cas de flaques d'eau sur l'asphalte.
- Lors de la conduite sur sol mouillé ou sur sol à faible adhérence (neige, verglas, boue...), garder une vitesse modérée en évitant les freinages brusques et les manœuvres brusques.
- Gardez une distance de sécurité avec les véhicules qui vous précèdent.
- Avant de dépasser, vérifiez qu'il n'y a pas d'obstacles devant le véhicule que vous devez dépasser et vérifiez toujours par les rétroviseurs qu'il n'y a pas d'autres véhicules venant de l'arrière.
- Freiner utilisant simultanément les freins avant et arrière : cela permet de maintenir la stabilité du véhicule.
- Si vous vous sentez fatigué ou somnolent, arrêtez-vous et reposez-vous. L'utilisation continue des freins en descente peut provoquer une surchauffe des plaquettes de frein, limitant l'action de freinage.
- Ne coupez pas le moteur en descente.
- Lorsque vous voyagez avec le passager, augmentez les distances de sécurité avec les véhicules qui vous

précèdent et tenez compte du poids du passager au freinage et lorsque vous devez effectuer un virage ou un dépassement.

- La position du pilote et du passager est importante pour le contrôle du véhicule.
- Pendant la conduite, le pilote doit garder les deux mains sur le guidon et les deux pieds sur les repose-pieds pour garder le contrôle de la moto.
- Le passager doit toujours se tenir au pilote ou à la poignée avec les deux mains, et garder les deux pieds sur les repose-pieds. Ne transportez jamais un passager à moins qu'il ne soit capable de placer fermement les deux pieds sur ses repose-pieds.
- Ne conduisez jamais sous l'influence de l'alcool ou de drogues.
- Ce scooter est conçu pour une utilisation sur route uniquement. Il n'est pas adapté à une utilisation hors route.
- N'utilisez pas de lacets, cordes etc. pour sécuriser les bagages, n'utilisez que des sacs homologués adaptés au type de moto que vous utilisez.
- La charge maximale transportable (pilote, passager et bagages) ne doit pas dépasser 155 kg (342 lb.). Le poids des bagages ne doit en aucun cas dépasser 5 kg (11 lb).





1.5 SYSTÈME DE FREINAGE ANTIBLO-CAGE – ABS

L'ABS est un système d'aide au freinage électromécanique :

Il empêche le blocage des roues lors du freinage, contribuant ainsi à maintenir la stabilité du véhicule en présence de chaussées glissantes, humides ou sales.

Dans des conditions de mauvaise adhérence, le système peut intervenir en allongeant la distance de freinage (par exemple, présence de gravier ou de surface glissante), mais garantit dans tous les cas l'espace minimum de freinage sur cette surface de route particulière.

- Le système ABS ne fonctionne pas à des vitesses inférieures à 10 km/h. Lorsque, lors d'un freinage, le système entre en action, des pulsations se font sentir sur le levier de frein : cette sensation ne doit pas conduire à relâcher la pression sur le levier, car cela annulerait l'action du système. De plus, la présence du système ABS ne doit pas conduire à des comportements de conduite dépassant les règles de prudence habituelles.
- Utilisez toujours les plaquettes frein et les pneus recommandés pour assurer le bon fonctionnement du système ABS.

1.6 RISQUES LIÉS AU MONOXYDE DE CARBONE

Les gaz d'échappement contiennent du monoxyde de carbone, un gaz incolore et inodore. L'inhalation de monoxyde de carbone peut provoquer une perte de conscience et la mort.

Si le moteur est démarré dans des pièces complètement ou partiellement fermées, l'air que vous respirez peut contenir une quantité dangereuse de monoxyde de carbone. Ne démarrez jamais la moto dans un garage ou un autre endroit clos.

 **DANGER**

Le monoxyde de carbone est un gaz toxique. Respirer ce gaz peut provoquer une perte de conscience et la mort. Évitez toute zone ou activité susceptible de vous exposer au monoxyde de carbone.



1.7 INFORMATIONS DE SÉCURITÉ

1.7.a Accessoires

Choisir les bons accessoires pour votre véhicule est une décision importante. Utilisez uniquement des accessoires d'origine, disponibles auprès des concessionnaires **Italjet** qui ont été testés et approuvés pour une utilisation sur votre véhicule.

L'ajout d'accessoires électriques doit être fait avec précaution. Si les accessoires électriques dépassent la capacité du système électrique du scooter, une panne du système électrique peut se produire.

1.7.b Transport du scooter

Avant de transporter votre scooter dans un autre véhicule, veuillez respecter les instructions suivantes.

- Retirez tous les objets en vrac du scooter.
- Orientez la roue avant en position de marche en ligne droite sur la remorque ou sur le plateau du camion et verrouillez-la convenablement pour l'empêcher de bouger.
- Fixez le scooter avec des cordes ou des sangles d'ancrage appropriées aux composants solides du scooter lui-même, tels que le cadre (et non par exemple aux indicateurs de direction ou à d'autres composants qui pourraient se casser). Choisissez avec soin l'emplacement de fixation des sangles pour éviter que les sangles ne frottent contre les pièces peintes pendant le transport.
- La suspension, si possible, doit être partiellement comprimée, afin que le scooter ne secoue pas excessivement pendant le transport.

1.7.c Clé pliable

La clé (1) du Dragster est pliable. Afin d'éviter de la casser, il est recommandé de plier la poignée de la clé (1) perpendiculairement à la clé elle-même pendant que le véhicule roule.





2.1 COMPOSANTS DU SCOOTER

Vue du côté droit

1. Repose-pieds du Pilote
2. Selle pilote
3. Siège passager
4. Poignées passager
5. Repose-pieds passager
6. Amortisseur arrière
7. Silencieux d'échappement
8. Boîte à gants





Vue côté gauche

1. Roue avant
2. Disque de frein avant
3. Etrier de frein avant
4. Bras simple avant
5. Amortisseur monobras
6. Verrou d'accès au compartiment sous la selle
7. Régulateur de tension
8. Moteur
9. Filtre à air
10. Béquille centrale
11. Filtre à air de boîte de vitesses
12. Disque et étrier de frein arrière
13. Roue arrière
14. Bouchon de réservoir de carburant
15. Réservoir d'essence
16. Béquille latérale

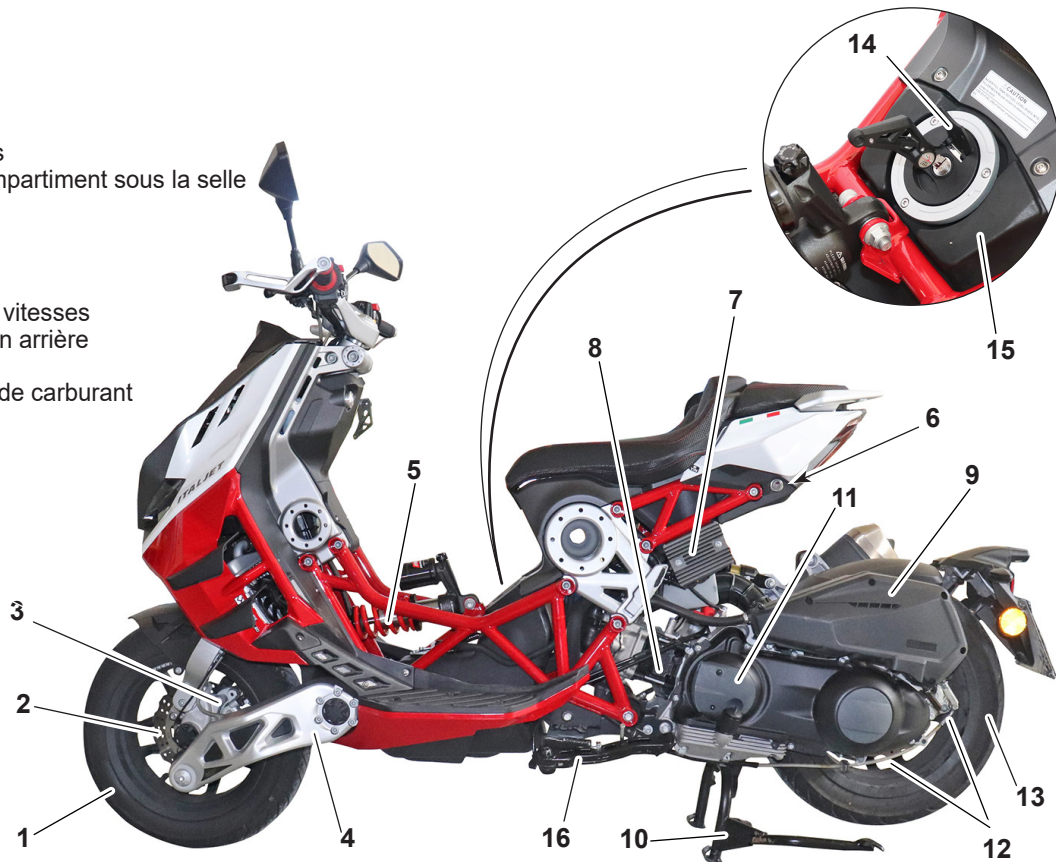



Vue avant et arrière

1. Rétroviseur droit
2. Rétroviseur gauche
3. Indicateur de direction droit
4. Indicateur de direction gauche
5. Feu avant
6. Radiateur droit
7. Radiateur gauche
8. Feu arrière
9. Flèche arrière gauche
10. Flèche arrière droite
11. Feu de plaque d'immatriculation
12. Support de plaque d'immatriculation

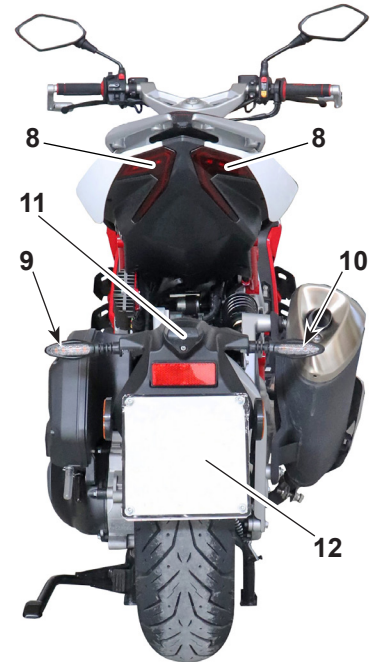
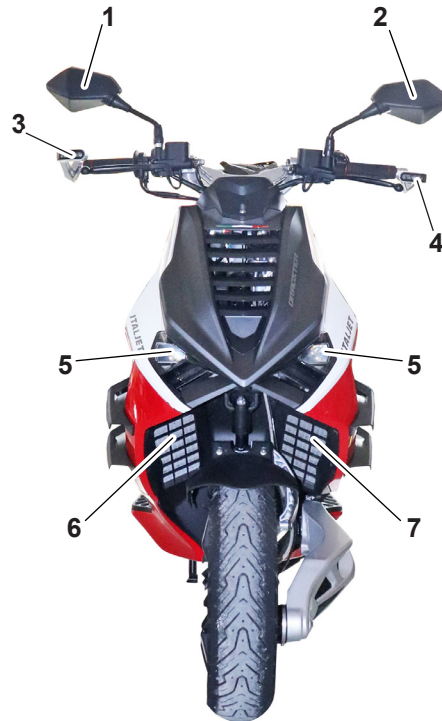



2.2 COMMANDES INSTRUMENTS

1. Bouton gauche
2. Bloc de commande gauche
3. Levier de frein arrière
4. Commande d'accélérateur
5. Bloc de commande droit
6. Levier de frein avant
7. Commutateur d'allumage
8. Prise USB
9. Instrumentation

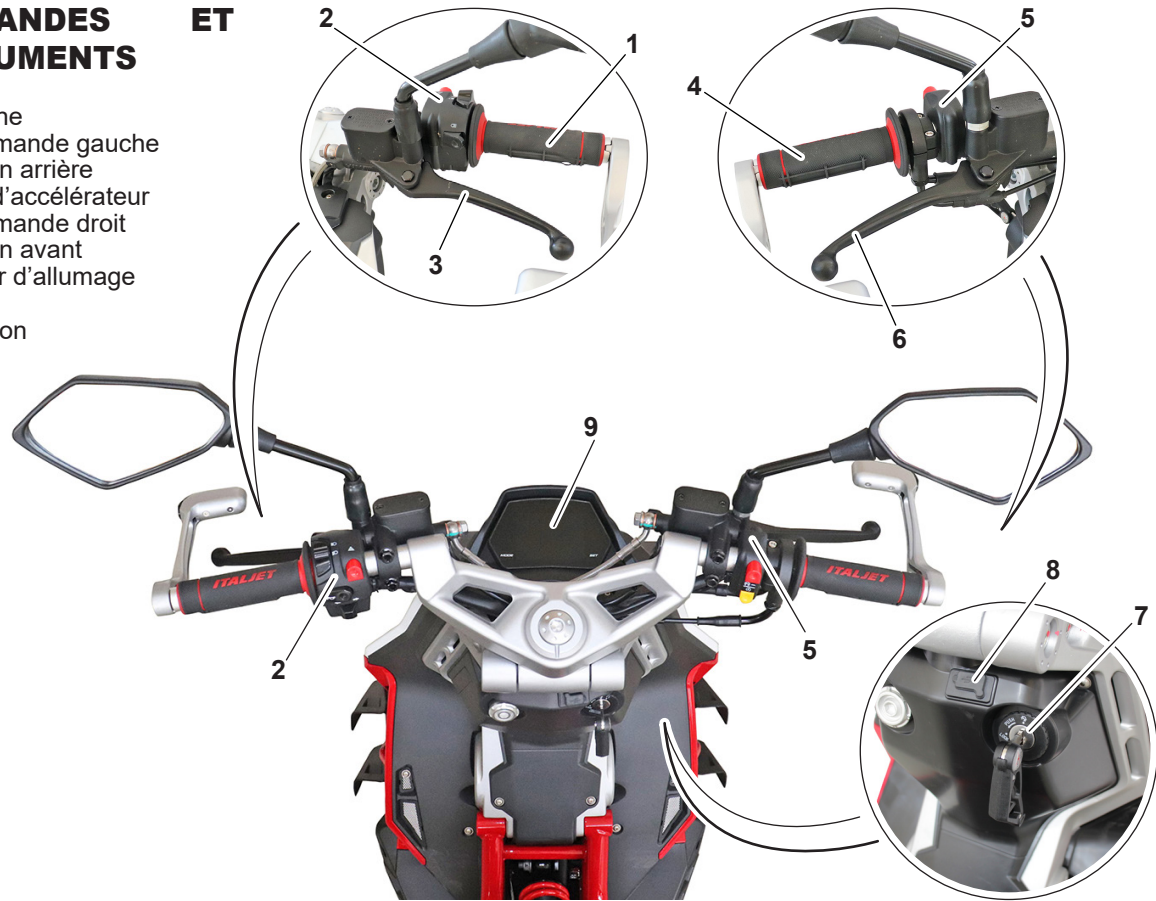



2.3 DONNÉES D'IDENTIFICATION

Le numéro d'identification du moteur est gravé à l'arrière/en haut du carter, tandis que le numéro de série est gravé sur le cadre sous la selle.

Référez-vous toujours, en le notant également dans ce livret, **au numéro gravé sur le cadre** lorsque vous commandez des pièces détachées ou demandez des informations sur votre moto.

NUMÉRO DE SÉRIE DU MOTEUR

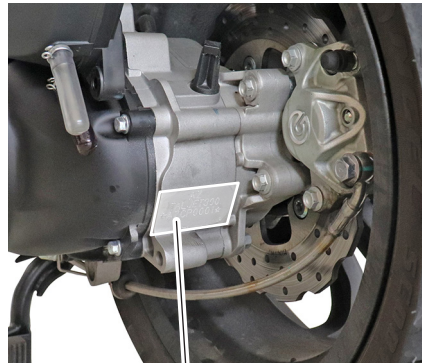

NUMÉRO DE SÉRIE DE LA MOTO





2.4 INSTRUMENTATION

2.4.a Indicateurs et voyants d'avertissement

- 1) Témoin de clignotant gauche.
- 2) Témoin de clignotant droit.
- 3) Témoin de pression d'huile moteur insuffisante.
- 4) Témoin de feux de route.
- 5) Témoin de température élevée du liquide de refroidissement.
- 6) Témoin de réserve de carburant.
- 7) Témoin ABS.
- 8) Témoin de panne moteur.

Témoin de clignotant gauche «←»

Le voyant clignote lorsque le clignotant gauche est inséré à l'aide du levier de commande spécial situé sur le bloc de commande gauche.

Témoin de clignotant droit «→».

Le voyant clignote lorsque l'indicateur de direction droit est inséré à l'aide du levier de commande spécial situé sur le bloc de commande gauche.

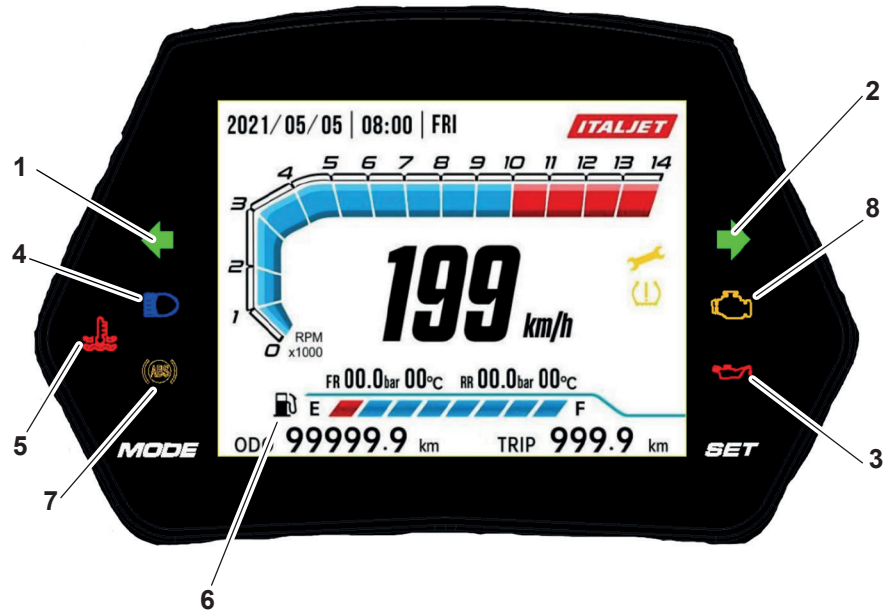

Témoin de pression d'huile moteur insuffisante «».

Il s'allume avec la clé de contact en position "ON" et doit s'éteindre lorsque le moteur tourne. S'il reste allumé ou s'allume avec le moteur

tournant, arrêtez le moteur et vérifiez le niveau d'huile comme décrit dans le paragraphe correspondant ou contactez votre revendeur pour faire vérifier le défaut.





ATTENTION

Ne pas utiliser la moto avec une pression d'huile insuffisante ; panne moteur possible.

Témoin de feux de route «».

Le témoin s'allume à l'allumage des feux de route à l'aide de la commande appropriée située sur le bloc de commande gauche.

Témoin de température d'eau élevée «».

Il s'allume lorsque la température du liquide de refroidissement a atteint la valeur maximale autorisée.

ATTENTION

Arrêtez la moto et coupez le moteur. Ne pas utiliser la moto avec une température de liquide de refroidissement élevée ; panne moteur possible.

- Attendez que le liquide de refroidissement refroidisse puis vérifiez le niveau comme décrit dans le paragraphe correspondant ou contactez votre revendeur pour vérifier le défaut.

Témoin de bas niveau de carburant «»

Si le témoin s'allume pendant l'utilisation de la moto, il indique que le niveau de carburant a atteint le niveau de réserve (2 litres), indiquant une autonomie limitée ; faire le plein dès que possible.

Témoin ABS «»

En tournant la clé, la centrale ABS effectue un autodiagnostic, le témoin s'allume quelques secondes puis s'éteint indiquant l'absence d'anomalie.

Si en revanche le témoin s'allume pendant que la moto roule, cela indique qu'il y a un défaut du système de freinage ABS :

- Arrêtez et coupez le moteur ;

- Attendre quelques minutes et redémarrer le moteur. Si le témoin se rallume, contactez le Concessionnaire **Italjet** le plus proche pour faire contrôler le système ABS.

Témoin de panne moteur «»

En tournant la clé de contact, l'unité de contrôle du moteur effectue un autodiagnostic, le témoin s'allume quelques secondes puis s'éteint indiquant l'absence d'anomalie.

Si le témoin s'allume moteur tournant, il indique qu'il y a un dysfonctionnement du moteur ou du système d'injection ;

- Arrêtez et coupez le moteur ;
- Attendre quelques minutes et redémarrer le moteur. Si le témoin s'allume, contactez le Concessionnaire **Italjet** le plus proche pour effectuer un contrôle du système d'autodiagnostic.





2.4.b Instrumentation numérique

- 1) Indicateur de vitesse (Compteur de vitesse) km / h - mi / h.
- 2) Date / heure / jour.
- 3) Jauge de carburant.
- 4) Indicateur du total de km parcourus.
- 5) Indicateur des km partiels parcourus.
- 6) Voyant d'avertissement de maintenance programmée expirée.
- 7) Bouton "MODE".
- 8) Bouton « RÉGLER ».

Indicateur de vitesse (1)

Indique la vitesse de la moto ; la vitesse peut être indiquée en km/h ou en mi/h selon la façon dont l'unité de mesure a été réglée.

Date / heure / jour de la semaine (2)

- 2a) Indique la date ; peut être affichée en « année/mois/jour » ou « jour/mois/année ».
- 2b) Indique l'heure ; peut être réglée sur une échelle de 24 heures ou de 12 heures.
- 2c) Indique le jour de la semaine.

Jauge de carburant (3)

Indique le niveau de carburant à l'intérieur du réservoir ; l'échelle complètement visible (3a) indique le ni-

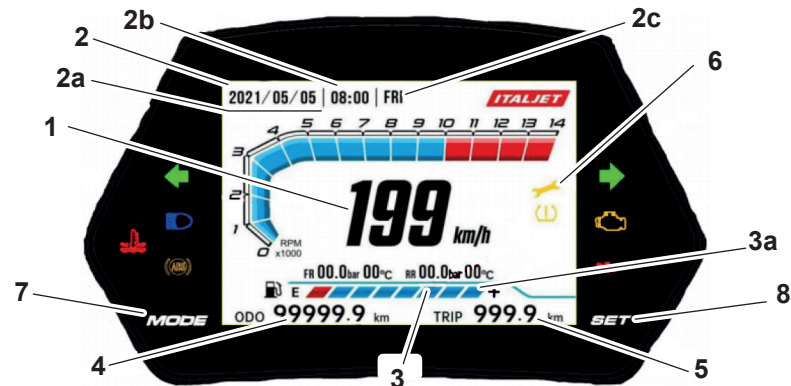

veau maximum, l'échelle non visible (3a) indique le niveau minimum, le voyant «  » s'allume.

Indicateur du total de km parcourus (4)

Cette partie de l'écran affiche le nombre total de km/mi parcourus.

Indicateur de kilomètres partiels parcourus (TRIP) (5)

Cette partie de l'écran affiche les km partiels parcourus depuis la dernière remise à zéro.

Indicateur de maintenance programmée expirée (6)

Le témoin clignote lorsque la maintenance est à 100km / 62mi.

Le voyant d'avertissement reste fixe lorsque le km / mi de l'intervalle d'entretien a été dépassé et reste fixe jusqu'à la réinitialisation. Après avoir effectué la maintenance, afficher TOTAL ODO, puis appuyer sur le bouton « **mode** » (7) pendant plus de 10 secondes ; le voyant d'entretien s'éteint.

Bouton MODE (7)

Le bouton "**mode**" permet de faire défiler le menu.

Bouton RÉGLER (8)

Le bouton "**set**" vous permet de définir l'unité de mesure et de supprimer les compteurs partiels.



2.5 RÉGLAGES ET AJUSTEMENTS DE L’AFFICHAGE

DANGER

Tous les réglages doivent être effectués avec la moto à l’arrêt.



Réglage km/mi et horloge 24 heures/12 heures

- Appuyez sur le bouton “**mode**” jusqu’à ce que le total km/mi s’affiche.
- Appuyez et maintenez enfoncé le bouton « set » pendant au moins dix secondes pour passer de l’unité de mesure km + horloge 24 heures à mi (miles) + horloge 12 heures et vice versa ; les compteurs partiels sont remis à zéro.

Réglage de l’heure

- Appuyez simultanément sur les touches « **mode** » et « **set** » pendant plus de deux secondes, les heures et les minutes se mettent à clignoter.
- Appuyez sur la touche “**mode**” pour augmenter les heures et sur la touche “Set” pour augmenter les minutes.
- Appuyez simultanément sur les touches “**mode**” et “**set**” pendant plus de deux secondes pour valider le réglage de l’heure.

Réglage km/mi et heures partielles « Trajet A ou Trajet B »

- Appuyez sur le bouton “mode” jusqu’à ce que “Trajet A” ou “Trajet B” s’affiche, en appuyant rapidement sur le bouton “set” vous pouvez basculer entre l’affichage des km/mi parcourus partiels aux heures partielles pour le trajet.
- Pour réinitialiser le km/mi partiel parcouru et le temps partiel, appuyez sur le bouton « set » pendant plus de deux secondes, les valeurs sont réinitialisées et un nouveau décompte recommence.



2.6 COMMANDES

2.6.a Serrure à clé

Le bloc de touches a trois positions :

↻ position de départ de la moto
(clé non amovible);

⊗ position d'extraction de clé;

“**lock**” position de verrouillage de la
colonne de direction (clé amovible).

- Position d'extraction de la clé “⊗”

En tournant la clé sur la position
“⊗”, le moteur et les feux s'étei-
gnent et la clé peut être retirée de la
serrure

- Position de démarrage “↻”

A partir de la position “⊗” (ex-
traction de la clé) tourner la clé (1) dans
le sens horaire jusqu'à la position “
↻”; les lumières, l'écran s'allumera
et la moto pourra démarrer.





2.6.b “Lock” antivol (verrouillage)

Pour verrouiller la colonne de direction, procédez comme suit :

- Tourner le guidon complètement vers la gauche
- Insérer la clé (1) sur le bloc (2) en position .
- Appuyez sur la clé (1) et tournez-la dans le sens inverse des aiguilles d'une montre jusqu'à la position « **Lock** ».
- Retirer la clé (2).







Pour déverrouiller la direction, opérer en marche arrière.





2.7 BLOC DE COMMANDE GAUCHE

Le bloc de gauche contient les commandes suivantes :

1.  Appel de phare.
2.  /  Interrupteur feux de croisement / feux de route.
3.  Interrupteur feux de détresse
4.  Klaxon.
5.  Commutateur d'indicateur de direction.



Feu de route “”

Appuyez sur le bouton (1) lorsque les feux de croisement sont allumés.





Interrupteur feux de croisement / feux de route “ / ”

Selon la position du commutateur (2), les feux de croisement ou de route s'allument :

-  Feux de croisement éclairés.
-  Feux de route éclairés.

Interrupteur Feux de Détresse “”



En appuyant sur le contacteur (3) tous les indicateurs de direction clignotent simultanément et les voyants “” et “” clignotent sur le tableau de bord.

NOTER : Utilisez les feux de détresse uniquement lorsque cela est nécessaire pour avertir les autres véhicules que votre moto est à l'arrêt. L'utilisation des feux de détresse avec le moteur éteint peut décharger les batteries.

Klaxon “”

Appuyez sur le bouton (4) pour actionner le klaxon.

Commutateur d'indicateur de direction “ / ”



Déplacer le commutateur (5) vers “” insère le clignotant gauche, déplacer le commutateur (5) vers “” insère le clignotant droit : Une fois relâché, l'interrupteur revient en position centrale. Pour éteindre l'indicateur de direction inséré, appuyez sur le commutateur une fois qu'il est en position centrale.





2.8 BLOC DE COMMANDE DROIT

Le bloc de droite contient les commandes suivantes :

1.  Interrupteur d'urgence arrêt du moteur.
2.  Bouton de démarrage du moteur.



2.8.a Bouton d'arrêt d'URGENCE



ATTENTION

Appuyez sur l'interrupteur (1) pour éteindre le moteur uniquement en cas d'urgence réelle.

Lorsqu'il est en position "  ", il désactive le démarrage et le fonctionnement du moteur.

Lorsqu'il est en position "  ", il permet au moteur de tourner et de démarrer.

2.8.b Bouton de démarrage du moteur

En appuyant sur le bouton (2) avec la clé en position "  " et le commutateur (1) en position "  ", appuyez sur un levier de frein et le moteur démarre.

2.9 COMMANDE DE L'ACCÉLÉRATEUR

La poignée des gaz (1) est située sur le côté droit du guidon.





2.10 COMMANDE DE FREIN AVANT

Le levier de frein (1) est situé sur le côté droit du guidon. Un interrupteur d'arrêt, lors du freinage, provoque l'allumage du feu arrière. Pour activer le frein, tirez le levier vers la poignée des gaz.

La position de la commande sur le guidon peut être réglée en desserrant les deux vis de fixation (2).

ATTENTION

N'oubliez pas de resserrer les vis (2) après réglage.

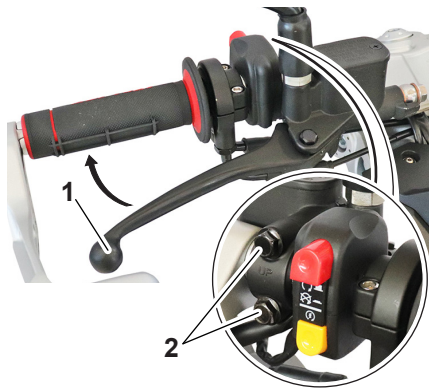

2.11 COMMANDE DE FREIN ARRIÈRE

Le levier de frein (1) est situé sur le côté gauche du guidon. Un interrupteur d'arrêt, lors du freinage, provoque l'allumage du feu arrière.

Pour activer le frein, tirez le levier vers le bouton.

La position de la commande sur le guidon peut être réglée en desserrant les deux vis de fixation (2).

ATTENTION

N'oubliez pas de resserrer les vis (2) après réglage.





2.12 RÉSERVOIR DE CARBURANT

DANGER

L'essence est extrêmement inflammable et peut devenir explosive dans certaines conditions. Coupez toujours le moteur, ne fumez pas et ne vous approchez pas de flammes ou d'étincelles dans la zone où vous faites le plein ou stockez du carburant.

2.12.a Ravitaillement

- Couper le moteur.
- Soulever le couvercle de serrure (1).
- Insérez la clé (2) et tournez-la de 1/4 de tour dans le sens de la flèche « A » pour retirer le capuchon (3).
- Verser le carburant dans le réservoir.

ATTENTION

Ne pas remplir le réservoir au-delà de la limite inférieure du goulot de remplissage, si le carburant déborde, nettoyer immédiatement le carburant avec un chiffon car, en plus d'être extrêmement inflammable, il peut détériorer les surfaces peintes ou plastiques.

- Remonter le capuchon (3) en procédant en sens inverse des opérations de démontage en tournant la clé dans le sens de la flèche « B » puis retirer la clé (2) et abaisser le couvercle de protection serrure (1).

NOTER : Il n'est pas possible de remonter le bouchon de réservoir (3) sans que la clé ne soit insérée dans la serrure ; il n'est possible de retirer la clé (2) du capuchon (3) que si ce dernier est correctement fermé.

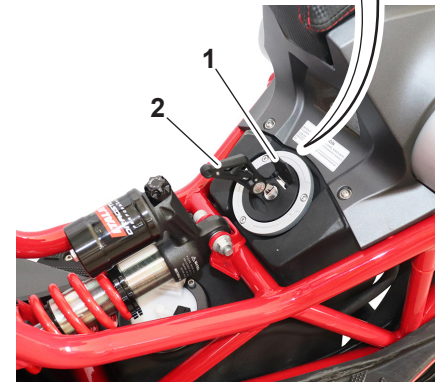
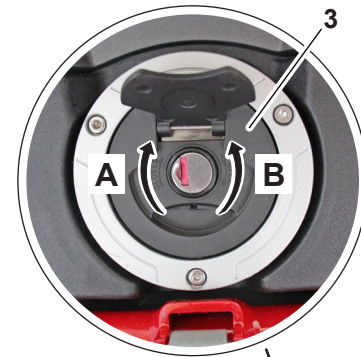



⚠ ATTENTION

Vérifiez que le bouchon du réservoir de carburant est bien fermé après avoir fait le plein. Les fuites de carburant constituent un risque d'incendie.

2.13 CARBURANT

⚠ ATTENTION

L'essence est toxique et peut causer des blessures ou la mort. Manipulez l'essence avec précaution. Ne jamais aspirer d'essence avec la bouche. Si de l'essence est ingérée ou si de grandes quantités de vapeurs d'essence sont inhalées, ou si de l'essence entre en contact avec les yeux, contactez immédiatement un médecin.

Si vous renversez de l'essence sur votre peau, lavez-la à l'eau et au savon. Si vous renversez de l'essence sur vos vêtements, changez-les.

Le moteur a été conçu pour utiliser de l'essence sans plomb avec un indice d'octane contrôlé de 95 ou plus. Si le moteur cogne, utilisez une autre marque ou de l'essence à indice d'octane plus élevé.

Carburant recommandé:

Essence sans plomb (E10 admissible)

Indice d'octane (RON):
95

E5

E10

NOTER :

- Cette référence identifie le carburant recommandé pour ce véhicule tel que spécifié par la réglementation européenne (EN228).
- Vérifier que le gicleur de la pompe à carburant a la même référence d'identification du carburant.

2.13.a Différents types d'essence

Il existe plusieurs types d'essence contenant de l'éthanol. L'essence contenant de l'éthanol peut être utilisée si la teneur en éthanol ne dépasse pas 10 % (E10). **Italjet** ne recommande pas l'essence contenant du méthanol car cela peut endommager le système d'alimentation en carburant ou entraîner des problèmes de performance du véhicule.

ATTENTION

N'utilisez que de l'essence sans plomb. L'utilisation d'essence au plomb causerait de graves dommages à la fois aux pièces internes du moteur, telles que les soupapes et les segments, et au système d'échappement.



2.13.b Pot catalytique

Le système d'échappement comprend des convertisseurs catalytiques pour réduire les émissions d'échappement nocives.

ATTENTION

Le système d'échappement atteint des températures élevées après avoir fait fonctionner la moto. Pour prévenir les risques d'incendie ou de brûlures :

- Ne garez pas le véhicule à proximité de matériaux pouvant présenter un risque d'incendie, tels que de l'herbe ou d'autres matériaux facilement inflammables.
- Garez le véhicule dans un endroit où il n'y a aucun danger que des piétons ou des enfants touchent le système d'échappement

chaud.

- Vérifier que le système d'échappement a refroidi avant d'effectuer des travaux de maintenance sur celui-ci.
- Ne pas faire tourner le moteur au ralenti même pendant quelques minutes. Un ralenti prolongé peut provoquer une accumulation de chaleur.

2.14 ACCESSOIRES POUR PRISE USB

ATTENTION

L'accessoire branché sur la prise USB ne doit pas être utilisé moteur éteint, et la charge ne doit jamais dépasser 12W (1A), sinon le fusible pourrait griller et la batterie se décharger.

2.14.a Pour utiliser la prise USB

- Soulever la protection (1).
- Branchez l'accessoire sur la prise (2).
- Lorsque la prise n'est pas utilisée, repositionnez correctement la protection.

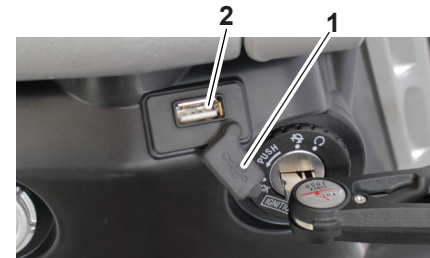



2.14.b Compartiment de rangement sous la selle

- Placer la moto sur la béquille latérale ou la béquille centrale.
- Insérez la clé (1) dans la serrure (2) et tournez-la jusqu'à ce que la serrure du siège soit déverrouillée.

- Soulevez la selle (3) pour accéder au compartiment (4).
- Pour fermer la selle, abaissez-la et poussez vers le bas pour qu'elle s'accroche dans la serrure.

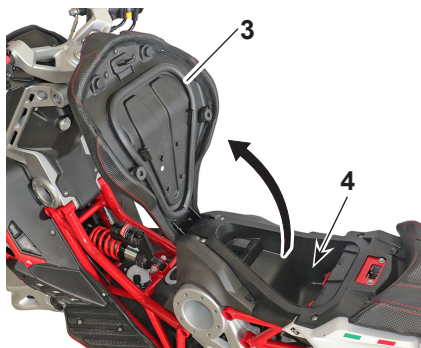
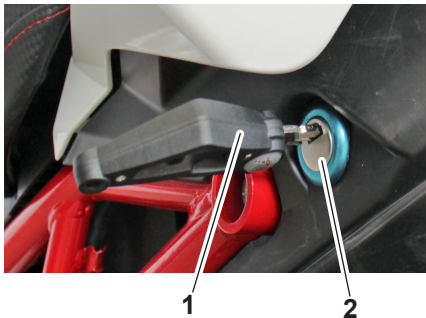

NOTER : Après avoir ouvert le compartiment sous la selle, la clé peut être retirée de la serrure.





2.14.c Béquille latérale

ATTENTION

La béquille est conçue pour supporter **UNIQUEMENT LE POIDS DE LA MOTO**.

Ne vous asseyez pas sur le véhicule en utilisant la béquille comme support ; une rupture pourrait se produire et entraîner des blessures corporelles graves.

ATTENTION

La moto **DOIT** être placée sur la béquille latérale **UNIQUEMENT APRÈS** que le pilote ait quitté le véhicule.

ATTENTION

Un capteur de sécurité est positionné sur la moto qui ne permet pas le démarrage de la moto, avec la béquille baissée.

Lorsque la béquille est abaissée avec la moto en marche, le moteur s'arrête.

La béquille latérale est située sur le côté gauche du cadre. Soulevez ou abaissez la béquille (1) avec votre pied tout en maintenant le véhicule en position verticale.



DANGER

Ne pas utiliser la moto avec la béquille latérale baissée.

Si la béquille latérale ne reste pas relevée, il est nécessaire de contacter le revendeur *Italjet* le plus proche pour la réparation.

Vérifier périodiquement le bon fonctionnement de la béquille latérale et le bon fonctionnement du capteur de sécurité qui bloque le démarrage de la moto avec la béquille baissée.



2.14.d Béquille centrale

- Saisir la poignée gauche du guidon (1) et la poignée du passager à gauche (2).
- Appuyez sur le levier (3) de la béquille centrale (4) avec votre pied droit et en même temps soulevez la moto vers le haut et vers l'arrière jusqu'à ce qu'elle soit complètement relevée sur la béquille centrale.

ATTENTION

Lorsque le véhicule est garé sur la béquille centrale, il est dangereux de s'asseoir sur le véhicule, mettant ainsi son poids sur la béquille de stationnement.

Pour descendre la moto de la béquille centrale, procéder comme décrit ci-dessous.

- Saisir la poignée gauche (1) et la poignée gauche (2) du passager.
- Placez votre pied devant la béquille et poussez la moto vers l'avant jusqu'à ce qu'elle se détache de la béquille ; le support se lèvera automatiquement.





3.1 CONTRÔLES AVANT UTILISATION

Inspectez le véhicule chaque fois que vous l'utilisez pour vous assurer qu'il est en bon état de fonctionner. Respectez toujours les procédures et les intervalles d'inspection et d'entretien décrits dans le manuel d'utilisation et d'entretien.

ATTENTION

Le défaut d'effectuer une inspection ou un entretien approprié du véhicule augmente la possibilité d'accidents ou de dommages au véhicule. N'utilisez pas le véhicule si vous rencontrez des problèmes. Si le dysfonctionnement ne peut pas être éliminé avec les instructions fournies dans ce manuel, faites inspecter le véhicule par un concessionnaire Italjet.

Avant d'utiliser ce véhicule, veuillez vérifier les points suivants :

ÉLÉMENT	CONTRÔLES
<i>Le carburant</i>	<ul style="list-style-type: none">- Vérifiez le niveau de carburant dans le réservoir de carburant.- Remplir si nécessaire.- Vérifier s'il y a des fuites dans le circuit de carburant.
<i>L'huile de moteur</i>	<ul style="list-style-type: none">- Vérifiez le niveau d'huile dans le moteur.- Si nécessaire, rajouter de l'huile du type préconisé jusqu'au niveau.- Vérifier l'absence de fuites d'huile du moteur.
<i>Huile de transmission finale</i>	<ul style="list-style-type: none">- Vérifier l'absence de fuites d'huile de la transmission.
<i>Liquide de refroidissement</i>	<ul style="list-style-type: none">- Vérifier le niveau du liquide de refroidissement dans le vase d'expansion.- Si nécessaire, faites l'appoint de liquide de refroidissement.- Vérifier qu'il n'y a pas de fuites dans le système de refroidissement.
<i>Roues et pneus</i>	<ul style="list-style-type: none">- Vérifiez les dommages.- Vérifier l'état des pneumatiques et la profondeur des sculptures.- Vérifier la pression d'air.



ÉLÉMENT	CONTRÔLES
Freins	<ul style="list-style-type: none">- Vérifier le fonctionnement des freins.- Si vous ressentez une sensation de trop de souplesse, faites contrôler le système de sécurité par un revendeur Italjet.- Vérifier l'usure des plaquettes de frein.- Les remplacer si nécessaire (pour le remplacement, contacter un revendeur Italjet).- Vérifier le niveau de liquide dans le réservoir, faire l'appoint si nécessaire (pour faire l'appoint, contacter un revendeur Italjet).- Vérifier qu'il n'y a pas de fuites dans le système hydraulique.
Béquille latérale, béquille centrale	<ul style="list-style-type: none">- Assurez-vous que le mouvement est fluide.- Lubrifier les points de pivot si nécessaire.
Instruments, feux, indicateurs de direction	<ul style="list-style-type: none">- Vérifiez le fonctionnement des feux, indicateurs de direction.
Commutateur de béquille latérale	<ul style="list-style-type: none">- Vérifier le fonctionnement du système d'interruption du circuit d'allumage.- Si le système ne fonctionne pas correctement, faites contrôler le véhicule par un concessionnaire Italjet.





3.2 INSTRUCTIONS D'UTILISATION DU MOTOCYCLE

NOTER : *Si vous n'êtes pas familiarisé avec le fonctionnement du motorcycle, avant de la conduire, lisez attentivement les instructions contenues dans le paragraphe « COMMANDES ».*

3.2.a Instructions de rodage

Durant les 1000 premiers km, les règles suivantes doivent être scrupuleusement respectées, dont le NON-RESPECT PEUT JUGER DE LA VIE ET DES PERFORMANCES DU MOTOCYCLE :

- Avant d'utiliser le véhicule, chauffer le moteur à régime réduit ;
- Evitez les démarrages rapides et ne faites pas tourner le moteur à haut régime ;
- Rouler à vitesse modérée jusqu'à ce que le moteur se réchauffe ;
- Utilisez à plusieurs reprises les deux freins pour faire fonctionner les plaquettes et les disques ;
- Éviter de maintenir la même vitesse

- pendant longtemps ;
- Évitez de parcourir de longues distances sans vous arrêter.

3.2.b Identification des problèmes de fonctionnement

La liste suivante d'éventuels problèmes de fonctionnement sert, en général, à identifier leur origine et à mettre en œuvre le remède.

Le moteur ne démarre pas

- Technique de démarrage inadéquate : suivre les instructions du paragraphe « Démarrage du moteur » ;
- Béquille latérale abaissée.

Le moteur est lent à démarrer

- Bougie sale ou en mauvais état : remplacer

Le moteur démarre mais le fonctionnement est irrégulier

- Bougie sale ou en mauvais état : remplacer ;

La bougie se salit facilement

- Bougie défectueuse, remplacer

Le moteur manque de puissance

- Filtre à air sale : nettoyer ;

Les freins ne fonctionnent pas correctement

- Plaquettes usées : remplacer chez un réparateur spécialisé.

ATTENTION

Pour tout autre problème, contactez un revendeur *Italjet*.



3.3 MONTÉE / DESCENTE PILOTE ET PASSAGER

3.3.a Règles générales

Lisez attentivement les instructions suivantes car elles fournissent des informations importantes pour la sécurité du pilote et du passager afin d'éviter des blessures aux personnes ou des dommages à la moto.

Monter et descendre de la moto doit toujours se faire du côté gauche de la moto, les mains libres, sans gêne et avec la béquille centrale relevée. Si la béquille latérale est présente, le pilote peut monter avec la béquille abaissée.

Le motard doit être le premier à monter et le dernier à descendre de la moto et doit contrôler la stabilité de la moto pendant la montée et la descente du passager. Ne descendez pas du véhicule en sautant ou en allongeant la jambe, descendez toujours en effectuant les opérations décrites dans le paragraphe correspondant.

3.3.b Montée du pilote

Relevez la béquille centrale. S'il y a une béquille latérale, laissez-la en position abaissée.

- Du côté gauche, tenez correctement le guidon à deux mains, puis soulevez la jambe droite et dépassez la selle.
- Asseyez-vous sur la moto et posez les deux pieds au sol, en redressant le véhicule sans charger votre poids sur la béquille latérale (si présente).

ATTENTION

Si vous ne parvenez pas à poser les deux pieds au sol, placez votre pied droit avec votre pied gauche prêt à être soutenu.

- Avec le pied gauche, escamoter complètement la béquille latérale (si présente) ;
- Démarrer la moto comme décrit dans le paragraphe correspondant.

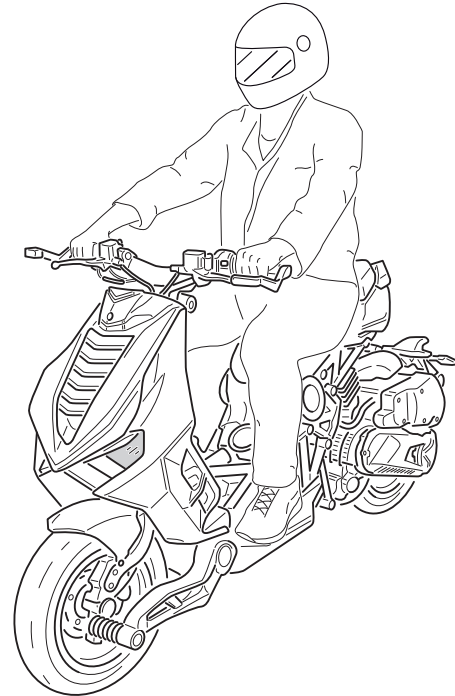



3.3.c Montée du passager

- Le pilote doit monter sur le motorcycle comme décrit au paragraphe correspondant, sans démarrer le motorcycle.
- Le passager doit extraire les repose-pieds (1).

ATTENTION

Le pilote en position de conduite ne doit absolument pas extraire ou tenter d'extraire les repose-pieds des passagers arrière, car cela pourrait compromettre l'équilibre du véhicule.

- Montez sur le véhicule en levant la jambe droite en bougeant prudemment pour ne pas déséquilibrer le véhicule et le pilote.

- Avec vos mains tenez les poignées (2).
- Avec votre pied gauche, rétractez complètement la béquille latérale (si présente).
- Démarrer la moto comme décrit dans le paragraphe correspondant.

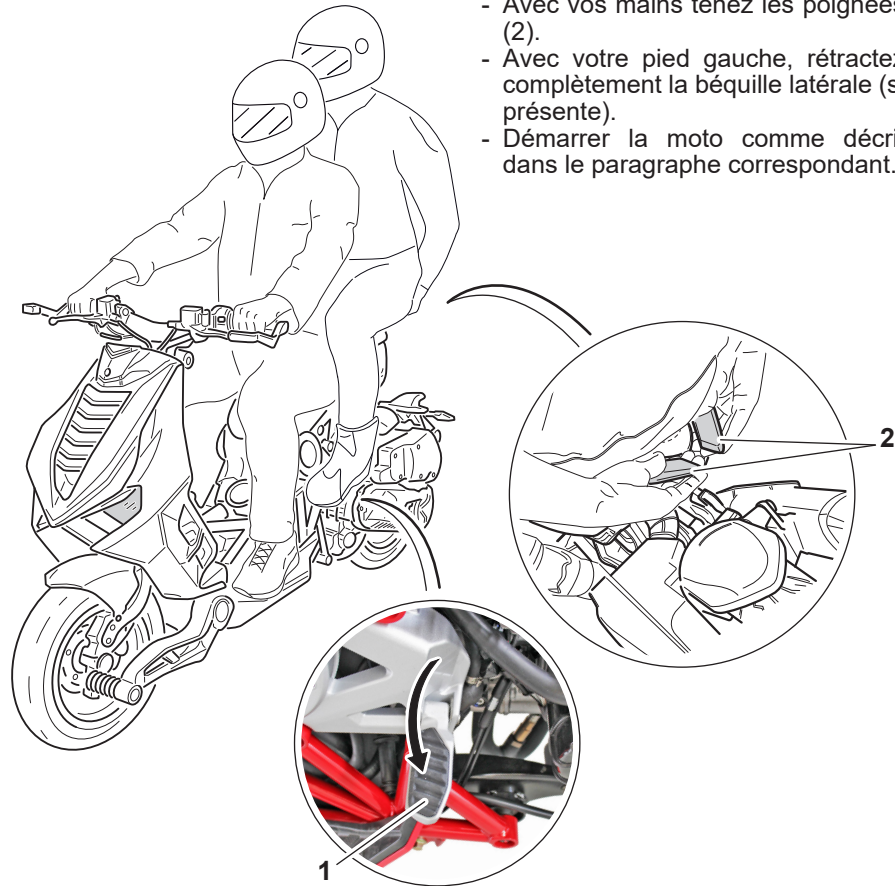



3.3.d Descente de la moto

- Arrêtez le véhicule et coupez le moteur.

ATTENTION

Assurez-vous que la zone où le véhicule doit être garé est stable et de niveau.

- Placer les deux pieds au sol.
- Eteindre la moto comme décrit dans le paragraphe correspondant.
- Avec votre pied gauche, extrayez complètement la béquille latérale (si présente).
- Le passager doit d'abord descendre du côté gauche du véhicule en levant la jambe droite.
- Basculer la moto vers la gauche jusqu'à ce qu'elle repose sur la béquille latérale, si présente.
- Les mains fermement sur le guidon, descendez du vélo par le côté gauche en levant la jambe droite.

3.4 RÉGLAGE DES RÉTROVISEURS

Asseyez-vous sur la moto comme décrit dans le paragraphe correspondant.

Ajuster les deux rétroviseurs (1) en les dirigeant directement afin que depuis la position assise du pilote puisse voir correctement la partie arrière de la route.





4.1 DÉMARRAGE DE LA MOTO

Après être monté sur la moto, comme indiqué dans le paragraphe correspondant, pour démarrer le moteur, procédez comme suit :

NOTER : La moto ne démarrera pas si la béquille latérale est abaissée.

- Mettre la clé (1) du contacteur d'allumage en position "  ".



- Le témoin "  " s'allume quelques secondes puis s'éteint tandis que les témoins "  ", "  " restent allumés jusqu'au démarrage de la moto.

- S'assurer que la manette des gaz (2) soit complètement relâchée et que la béquille latérale soit en position de marche.
- Tirez l'un des deux leviers de frein.
- Appuyez sur le bouton de démarrage du moteur (3) et relâchez-le dès que le moteur démarre.



NOTER : Le témoin « ABS » reste allumé jusqu'à ce que le véhicule atteigne une vitesse de 10 km/h (6mi/h), puis il s'éteint.

NOTER : Ne faites pas tourner le moteur froid à un nombre de tours élevé afin de permettre à l'huile de chauffer et de circuler dans tous les points nécessitant une lubrification.



4.1.a Utilisation de l'accélérateur

- Relâcher le levier de frein tiré et tourner simultanément la poignée des gaz (1) ; la vitesse est directement proportionnelle à la rotation de la poignée des gaz, en tournant le bouton vers « A » la moto accélère, en tournant le bouton vers « D » la moto décélère.

4.1.b Utilisation des freins

Pour avoir une action de freinage plus incisive, il est conseillé d'appliquer les deux freins en même temps.

- Relâcher la poignée des gaz (1) et tirer les deux leviers de frein (2) en augmentant progressivement la pression selon le degré de freinage souhaité.

ATTENTION

Évitez les freinages brusques, soyez très prudent lors du freinage avec la moto dans une pente, risque de chute. Dans certaines conditions, l'utilisation indépendante du frein avant ou arrière peut être utile. Utilisez le frein avant avec précaution, surtout sur sol glissant. Une mauvaise utilisation des freins peut provoquer des accidents graves.





4.1.c Arrêt de la moto et du moteur

- Relâcher complètement la poignée des gaz (1) pour décélérer la moto.
- Appiquer les freins avant et arrière.
- Une fois la moto arrêtée, tournez la clé de contact (2) en position "⊗" (position retrait clé), le moteur s'arrête.



4.1.d Arrêt du moteur en cas d'urgence

- Pour arrêter le moteur en cas d'urgence, appuyez sur l'interrupteur rouge (1) sur "⊗"; après avoir arrêté la moto, remettre le contacteur (1) en position "↻".

ATTENTION

En cas de blocage de l'accélérateur en position ouverte ou de tout autre dysfonctionnement provoquant une vrille incontrôlable du moteur, appuyez IMMÉDIATEMENT sur le bouton d'arrêt du moteur (1). Gardez le contrôle de la moto avec une utilisation normale des freins et de la direction tout en appuyant sur le bouton d'arrêt.



4.1.e Stationnement de la moto

Placer la moto sur la béquille latérale ou sur la béquille centrale comme décrit dans les paragraphes correspondants.

ATTENTION

- Après avoir éteint la moto, le moteur et le système d'échappement peuvent devenir très chauds, essayez de vous garer afin que les piétons ne touchent pas accidentellement ces pièces.
- Ne vous gariez pas à côté d'herbe sèche ou d'autres matériaux inflammables pouvant s'enflammer.
- Ne pas stationner sur des pentes ou sur un sol meuble ; la moto pourrait se renverser avec une fuite de carburant et un risque d'incendie.



5.1 ENTRETIEN ET CONTRÔLES PÉRIODIQUES

5.1.a Entretien périodique

Des inspections, des réglages et des graissages périodiques maintiennent la moto dans les meilleures conditions possibles de sécurité et d'efficacité. Les points les plus importants concernant les contrôles, les réglages et la lubrification de la moto sont illustrés dans les pages suivantes.

Les intervalles d'entretien indiqués dans le tableau ne doivent être considérés qu'à titre indicatif dans des conditions de conduite normales. Cependant, il peut être nécessaire de réduire les intervalles d'entretien en fonction des conditions climatiques, du terrain, de la position géographique et de l'utilisation individuelle.

ATTENTION

Un manque d'entretien ou un entretien incorrect de la moto peut augmenter le risque de blessures ou de décès lors de l'utilisation du véhicule. **Faites effectuer l'entretien par un revendeur *Italjet* ou un réparateur professionnel.**

ATTENTION

Avant d'effectuer toute opération de maintenance, vérifiez que vous disposez de l'outillage, des composants et des compétences techniques nécessaires.

- Couper le moteur et garer la moto sur une surface plane et solide.
- Attendre que le moteur, le silencieux et les disques de frein refroidissent.

ATTENTION

Si vous utilisez le véhicule sur des routes poussiéreuses, boueuses ou très humides, il est nécessaire de nettoyer / remplacer le filtre à air avec un intervalle d'entretien plus court. Rendez-vous chez le concessionnaire *Italjet* pour connaître l'intervalle d'entretien correct.



Intervalle d'entretien	<i>Temps ou kilométrage</i>											
	Temps (Mois)	6	12	18	24	30	36	42	48	54	60	66
Éléments	Kilométrage (km x 1000)	1	6	12	18	24	30	36	42	48	54	60
Moteur												
Rouleau de poulie conduite				L		L		L		L		L
Douille en plastique de couvercle de variateur				R		R		R		R		R
Cloche d'embrayage			C	C	C	C	C	C	C	C	C	C
Courroie de transmission				R		R		R		R		R
Filtre à air de boîte de vitesses				I		I		I		I		I
Préfiltre à maille pour huile moteur	C	C	C	C	C	C	C	C	C	C	C	C
Filtre à huile moteur	R	R	R	R	R	R	R	R	R	R	R	R
Jeu des soupapes				A		A		A		A		A
Huile de moyeu	R			R		R		R		R		R
Huile de moteur (*)	R	R	R	R	R	R	R	R	R	R	R	R
Rouleaux du variateur CVT				R		R		R		R		R
Demi-poulie mobile variateur				I		I		I		I		I
Transmission				L		L		L		L		L
Bougie				R		R		R		R		R
Filtre à air			C	C	C	C	C	C	C	C	C	C



Intervalle d'entretien	<i>Temps ou kilométrage</i>											
	Temps (Mois)	6	12	18	24	30	36	42	48	54	60	66
Éléments	Kilométrage (km x 1000)	1	6	12	18	24	30	36	42	48	54	60
Système de vaporisation												
Conteneur et tubes		I		I		I		I		I		I
Système de refroidissement												
Niveau de liquide de refroidissement (**)		I	I	I	I	I	I	I	I	I	I	I
Radiateur				C		C		C		C		C
Alimentation												
Filtre à carburant				R		R		R		R		R
Tuyaux de carburant (***)		I		I		I		I		I		I
Système électrique												
Voltage de batterie		I		I		I		I		I		I
Réglage des phares				A		A		A		A		A
Essai du véhicule sur route												
Essai du véhicule sur route		I		I		I		I		I		I



Intervalle d'entretien	<i>Temps ou kilométrage</i>											
	Temps (Mois)	6	12	18	24	30	36	42	48	54	60	66
Éléments	Kilométrage (km x 1000)	1	6	12	18	24	30	36	42	48	54	60
Châssis												
Fixations de sécurité		I		I		I		I		I		I
Freins		I	I	I	I	I	I	I	I	I	I	I
Liquide de frein (**)		I		I		I		I		I		I
Suspensions				I		I		I		I		I
Roues / pneus		I	I	I	I	I	I	I	I	I	I	I
Système de direction		I		I		I		I		I		I
Système d'échappement				I		I		I		I		I
Commande d'accélérateur		A		A		A		A		A		A

I: Vérifier et nettoyer, régler, graisser ou remplacer si nécessaire

C: Nettoyer

R: Remplacer

A: Ajuster

L: Lubrifier

(*) Vérifier le niveau tous les 3000 km

(**) Remplacer tous les 2 ans

(***) Remplacer tous les 4 ans



5.1.b Contrôle du niveau d'huile

NOTER : Le contrôle doit être effectué avec le moteur à peine arrêté et encore chaud.

ATTENTION

Le silencieux de la moto atteint des températures élevées, veillez à ne pas vous brûler.

- Placer la moto sur une surface plane, en position verticale surélevée sur la béquille centrale.
- Attendre quelques minutes pour permettre à l'huile de se déposer.
- Dévisser la jauge (1) et la retirer, nettoyer la jauge avec un chiffon et la réinsérer dans l'orifice de remplissage (2) sans la visser, puis la retirer et vérifier que le niveau d'huile se situe entre les repères de niveau minimum "MIN" et maximum "MAX".
- En cas d'appoint, introduire de l'huile par l'orifice (2) jusqu'au niveau MAX et pas au-delà.
- Remonter la jauge (1) en la vissant.

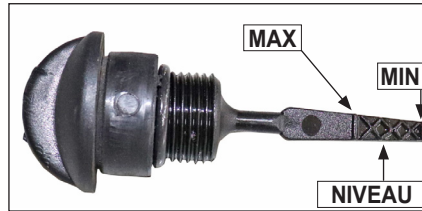

5.1.c Remplacement de l'huile moteur et du filtre

NOTER : Le remplacement de l'huile doit être effectué avec le moteur à peine éteint et encore chaud.

ATTENTION

Attention à ne pas vous brûler avec de l'huile chaude.

- Placer la moto sur une surface plane, en position verticale surélevée sur la béquille centrale.
- Retirer la jauge d'huile (1).

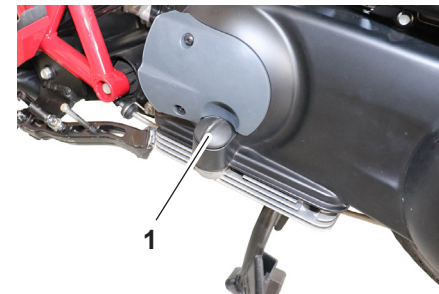



- Placer une bassine en correspondance avec le bouchon de vidange (2).
- Dévisser le bouchon de vidange (2) et laisser s'écouler toute l'huile.

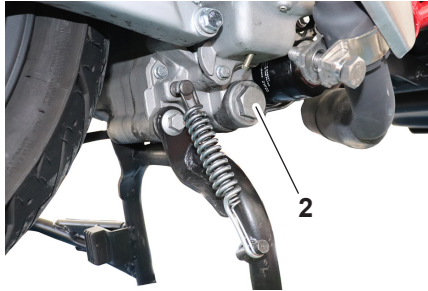

- À l'aide de l'outil (4), dévisser le filtre à huile (5).

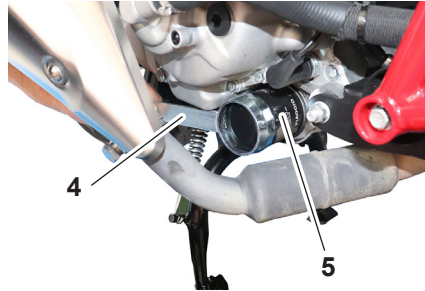

- Nettoyer le filtre (3), le remplacer s'il est endommagé, puis le remonter.

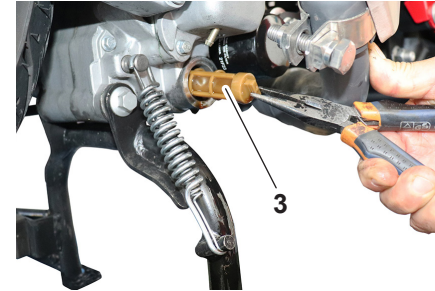

- Retirer le filtre lavable (3) à l'aide d'une pince.

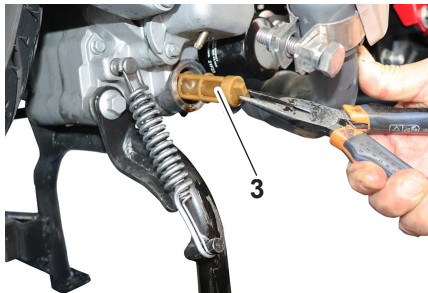

- Retirer le filtre (5).

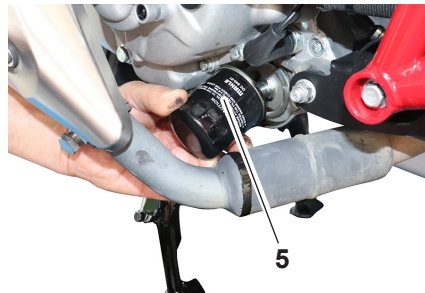

- Vérifier l'état du joint (6) du bouchon (2), le remplacer s'il est endommagé.

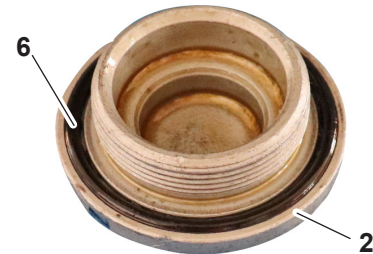



- Remonter le bouchon (2) en le vissant avec un couple de 25 Nm / 18.44 ft/lb.

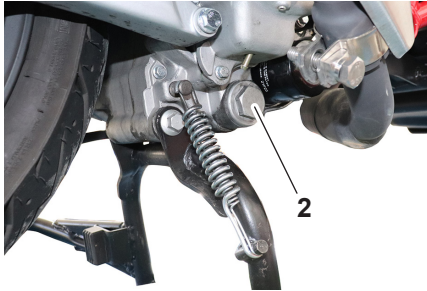

- Monter le filtre (5) en le vissant à l'aide de l'outil de filtrage (4) avec un couple de 12 Nm / 8.85 ft/lb.

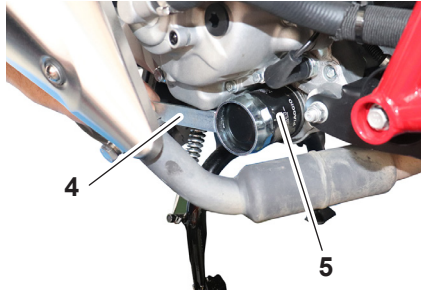

- Remonter la jauge (1) en la vissant.



NOTE : Pour le type d'huile à utiliser, voir le paragraphe « Ravitaillement en carburant ».

- Lubrifier le joint (7) avec de l'huile.



- Verser environ 1250 cm³ d'huile dans le réservoir d'huile par l'orifice (8).

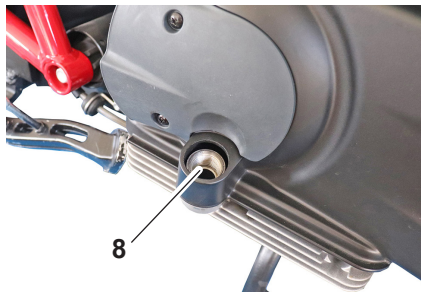

NOTE : Nettoyez toute huile renversée sur les pièces avec un chiffon une fois le moteur et le système d'échappement refroidis.

- Démarrer le moteur et laisser le tourner au ralenti quelques minutes en vérifiant qu'il n'y a pas de fuite d'huile. S'il y a une fuite d'huile, arrêtez immédiatement le moteur et recherchez la cause.
- Couper le moteur, vérifier le niveau d'huile et le corriger si nécessaire.
- Réinitialiser l'intervalle de maintenance comme décrit au paragraphe "Instrument numérique".





5.1.d Contrôle du niveau de liquide de refroidissement

NOTER : Vérifiez le niveau de liquide de refroidissement à moteur froid.

- Placer la moto sur une surface plane, en position verticale surélevée sur la béquille centrale.
- Retirer le couvercle (1) du vase d'expansion (2).

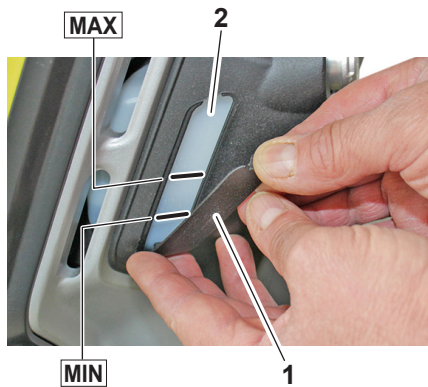

- Vérifier que le niveau de liquide se situe entre le niveau minimum « MIN » et le niveau maximum « MAX » du réservoir.

- S'il est nécessaire de faire l'appoint, retirer le bouchon du réservoir (3) en le dévissant et introduire le liquide de refroidissement par l'orifice (4) en vérifiant le niveau sur le réservoir (2).
- Une fois le niveau rétabli, remonter le bouchon (3) et le couvercle (1).

NOTER : Le liquide de refroidissement est corrosif, s'il en renverse un peu lors de l'appoint, nettoyez soigneusement les pièces qui ont été en contact avec l'eau.

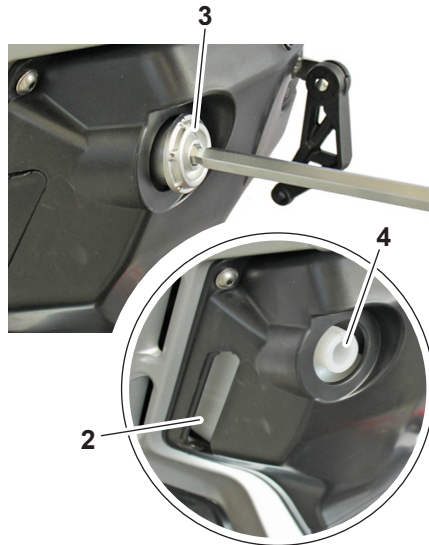

5.1.e Nettoyage du filtre à air du moteur

- Dévisser les vis (1) et retirer le couvercle (2).

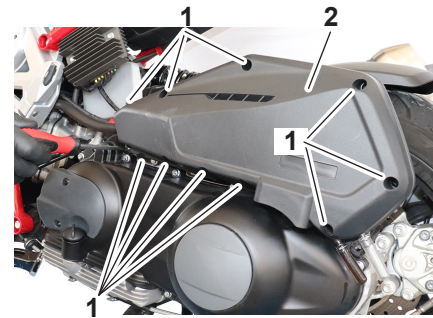

- Retirez le filtre (3) du couvercle du filtre (2).

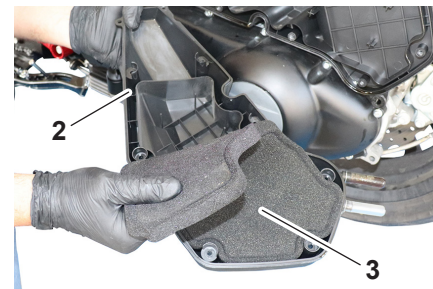



- Nettoyez le filtre (3) avec un nettoyant pour filtre approprié et laissez-le sécher complètement.

ATTENTION

N'utilisez pas d'essence ou d'autres solvants inflammables pour nettoyer le filtre.

- Vérifiez que le filtre n'est pas usé ou endommagé, remplacez-le si nécessaire.
- Appliquez de l'huile spécifique pour filtres sur toute la surface du filtre (3) puis le pressez pour éliminer l'excès d'huile.
- Remontez le filtre (3) sur le couvercle (2).

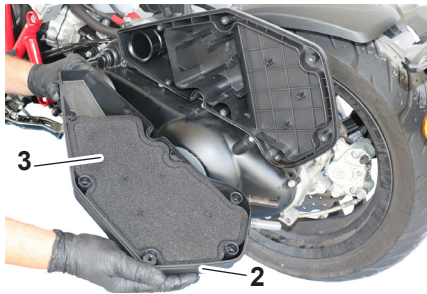

- Vérifier l'état du joint (4), le remplacer s'il est endommagé.

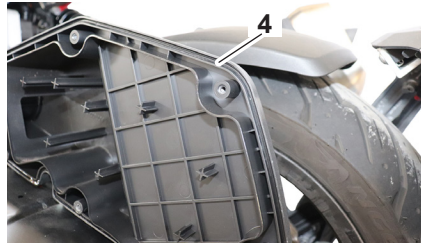

- Remonter le couvercle du filtre (2) en serrant les vis (1).

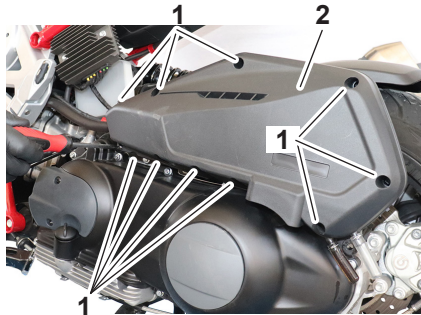

- Vérifier que les événements (5) et (6) ne sont pas encrassés. Si des saletés sont visibles, retirer les événements, nettoyer, puis remettre en place.

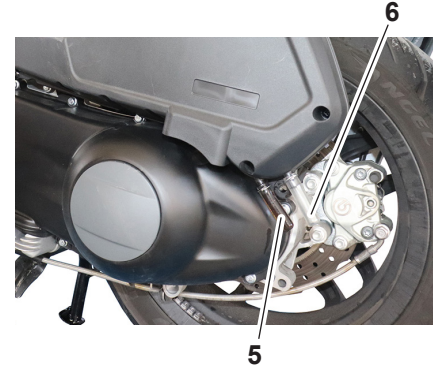



5.1.f Nettoyage du filtre à air de transmission

- Dévisser les vis (1) et retirer le couvercle (2).

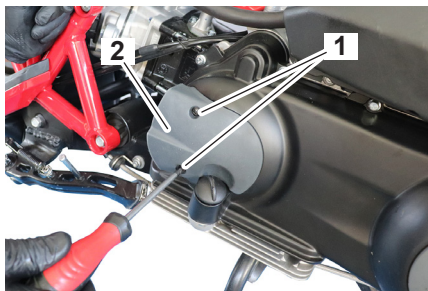

- Retirer le filtre (3) et nettoyer avec des produits de nettoyage appropriés.

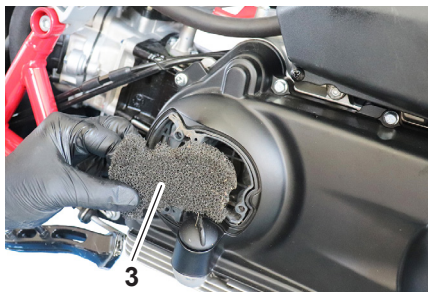

ATTENTION

N'utilisez pas d'essence ou d'autres solvants inflammables pour nettoyer le filtre.

- Vérifiez que le filtre n'est pas usé ou endommagé, remplacez-le si nécessaire.
- Vérifier l'état du joint (4) et remplacer, s'il est abîmé.

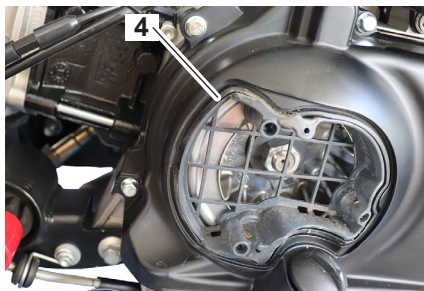

- Remonter le filtre (3) et le couvercle (2) dans l'ordre inverse du démontage.

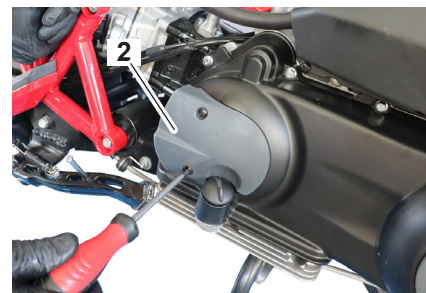



5.1.g Contrôle des bougies

ATTENTION

Attendre le refroidissement du moteur avant d'effectuer le contrôle ; danger de brûlures.

- Retirer le capuchon (1).
- A l'aide de la clé appropriée, retirer la bougie (2).

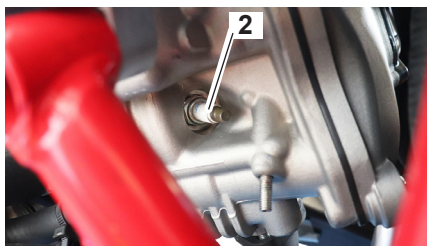

La distance entre les électrodes des bougies (2) doit être de $0,5 \div 0,6$ mm. Une distance différente peut entraîner un dysfonctionnement de la moto.

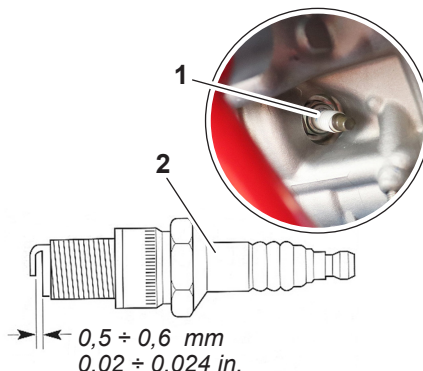

5.1.h Vérification des pneus et de la pression relative

Il est essentiel de toujours garder les pneus en bon état et de les remplacer à intervalles réguliers par des pneus conformes aux spécifications. Vérifiez toujours et, si nécessaire, ajustez la pression des pneus avant de partir.

ATTENTION

L'utilisation de la moto avec une pression de gonflage incorrecte peut entraîner des blessures graves ou la mort par perte de contrôle.

- Vérifiez et ajustez la pression des pneus à froid (c'est-à-dire lorsque la température des pneus est égale à la température ambiante).
- La pression des pneus doit être ajustée en fonction du poids total du pilote, du passager, de la charge et des accessoires homologués pour ce modèle.



5.1.i Contrôle des pneus

Cette moto est équipée de pneus tubeless.

- Vérifiez l'état des pneus, ils ne doivent pas présenter de fissures, d'abrasions, etc., vérifiez également l'usure de la bande de roulement à l'aide des indicateurs spéciaux sur le pneu lui-même.

HAUTEUR MINIMALE DE LA BANDE DE ROULEMENT

AVANT	2 mm (0.08 in)
ARRIÈRE	2 mm (0.08 in)

- Vérifier la pression selon les indications données dans le paragraphe des données techniques.

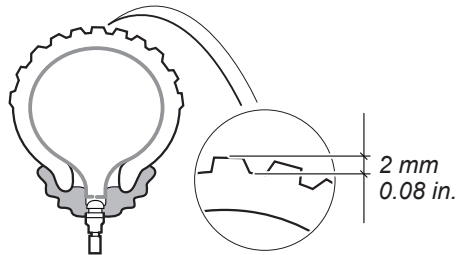

⚠ ATTENTION

Les pneus avant et arrière doivent être de la même marque et du même modèle, l'utilisation de différents types de pneus entre les roues avant et arrière compromet la stabilité de la moto et sa maniabilité.

NOTER : Les pneus vieillissent même s'ils ne sont pas visuellement usés ; des fissures latérales ou des déformations du carter sont un signe de vieillissement. Faites vérifier les pneus par un spécialiste du pneu avant d'utiliser la moto.

Pression des pneus à froid :

1 personne :

Avant :
190 kPa (1.9 Kgf/cm², 28 psi)

Arrière :
200 kPa (2.00 kgf/cm², 29 psi)

2 personnes :

Avant :
210 kPa (2.10 kgf/cm², 30 psi)

Arrière :
250 kPa (2.50 kgf/cm², 36 psi)

- Pour régler la pression, retirer le bouchon (1) et raccorder le manomètre à la valve du pneu (2).

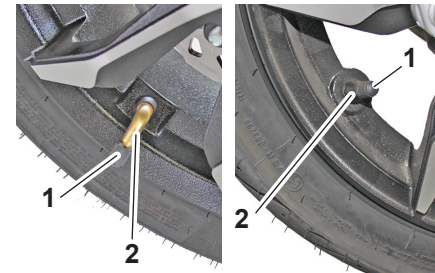



⚠ ATTENTION

- Remplacez les pneus trop usés chez un revendeur spécialisé. L'utilisation du véhicule avec des pneus excessivement usés réduit la stabilité et peut entraîner une perte de contrôle du véhicule.
- Rouler à vitesse modérée après avoir changé un pneu, pour permettre à la surface du pneu de « roder », afin qu'il puisse développer au maximum ses caractéristiques.

NOTER : Lors du remplacement d'un pneu, il est nécessaire d'équilibrer la roue.

Avant chaque utilisation, vérifiez toujours que les jantes ne présentent pas de fissures, de plis, de déformations ou d'autres dommages. Si vous constatez des dommages, faites remplacer la roue. N'essayez pas de faire la moindre réparation sur une roue. En cas de déformation ou de fissures, la roue doit être remplacée.

5.1.I Contrôle de l'usure des plaquettes de frein

Vérifier l'usure des plaquettes de frein avant (1) et des plaquettes de frein arrière (2).

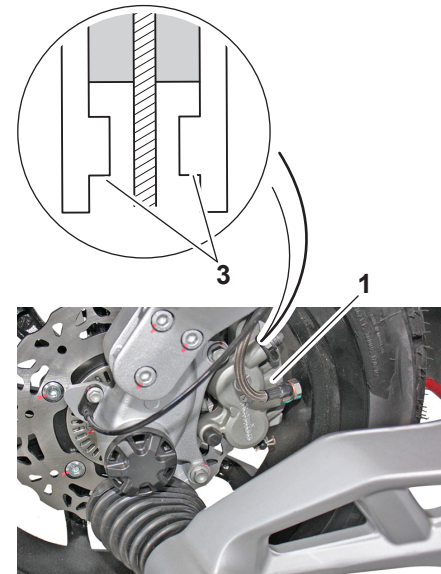



- Les plaquettes sont équipées d'un témoin d'usure (3). Pour vérifier l'usure de la plaquette, contrôler la position de l'indicateur d'usure (3) tout en appliquant le frein. Si une plaquette est usée au point que l'indicateur d'usure touche presque le disque de frein, remplacez les plaquettes par paires.

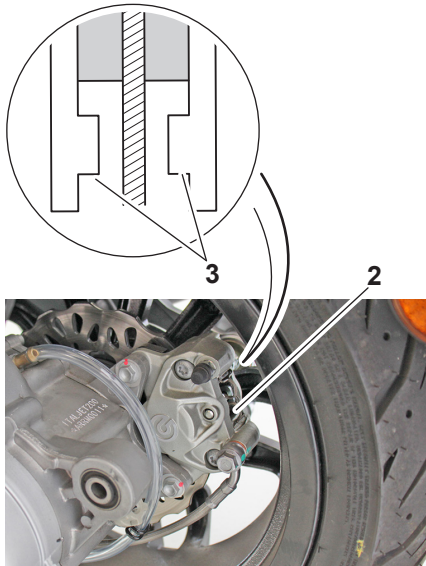

⚠ ATTENTION

Pour remplacer les plaquettes de frein, il est nécessaire de contacter un revendeur *Italjet*.

⚠ ATTENTION

Après avoir remplacé les plaquettes de frein, il est nécessaire de rouler prudemment, en freinant progressivement pour permettre aux plaquettes de bien se caler / se coupler avec les disques correspondants.





5.1.m Contrôle du niveau de liquide de frein avant/arrière

- Positionner la moto de manière que la partie supérieure du réservoir de frein soit parallèle au sol.
- Le niveau de liquide dans le réservoir de la pompe doit être au centre de la jante (1).

Tout abaissement du niveau de fluide peut permettre l'entrée d'air dans le système avec un allongement conséquent de la course du levier ; s'il est nécessaire de faire l'appoint, contactez votre revendeur *Italjet*.

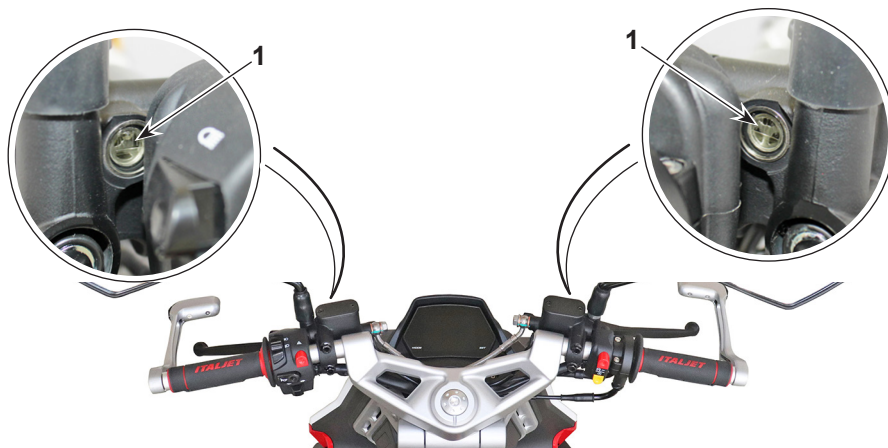

⚠ ATTENTION

Si le levier de frein est trop « mou », il y a de l'air dans le tuyau ou un défaut du système. Comme il est dangereux de conduire la moto dans ces conditions, faites contrôler immédiatement le système de freinage par votre concessionnaire *Italjet*.

ATTENTION

Ne pas verser de liquide de frein sur des surfaces peintes ou lentilles (par exemple des phares)

⚠ ATTENTION

Ne mélangez pas deux types de fluides différents. Si vous choisissez d'utiliser une autre marque de fluide, éliminez complètement la marque existante.

⚠ ATTENTION

Le liquide de frein peut provoquer une irritation. Éviter le contact avec la peau et les yeux. En cas de contact, nettoyez complètement la zone touchée et, s'il s'agit des yeux, appelez un médecin.





ATTENTION

- N'utiliser que le liquide de frein prescrit selon les spécifications ; sinon, les joints en caoutchouc peuvent se détériorer et provoquer des fuites.
- Faire l'appoint avec le même type de liquide de frein. L'ajout d'un liquide de frein autre que le DOT 4 peut provoquer une réaction chimique nocive.
- Eviter les infiltrations d'eau ou de poussière dans le réservoir de liquide de frein lors du ravitaillement. L'eau provoque une réduction significative du point d'ébullition du liquide et peut provoquer un "bouchon de vapeur", et la saleté peut obstruer les vannes du groupe hydraulique ABS.

ATTENTION

Le liquide de frein peut endommager les surfaces peintes ou les pièces en plastique. Nettoyez toujours immédiatement tout liquide renversé.

Au fur et à mesure que les plaquettes de frein s'usent, il est normal que le niveau de liquide de frein baisse progressivement. Si le niveau de liquide de frein est bas, il est possible que les plaquettes de frein soient usées et/ou qu'il y ait une fuite dans le circuit de freinage ; veillez donc à vérifier le niveau d'usure des plaquettes de frein et la présence de fuites dans le circuit de freinage.

Si le niveau de liquide de frein baisse brutalement, faites contrôler le véhicule par un concessionnaire *Italjet* avant de continuer à l'utiliser.

5.1.n Vidange du liquide de frein

Demandez à un concessionnaire *Italjet* de changer le liquide de frein tous les 2 ans. De plus, faites remplacer les joints des maîtres-cylindres et des étriers de frein, ainsi que les flexibles de frein, aux intervalles indiqués ci-dessous ou plus tôt s'ils sont endommagés ou fuient.

- Joints de freins : tous les 2 ans
- Flexibles de frein : tous les 4 ans

5.1.o Contrôle de la courroie trapézoïdale

La courroie trapézoïdale doit être vérifiée et/ou remplacée par un concessionnaire *Italjet* aux intervalles spécifiés dans le tableau d'entretien périodique.



5.1.p Contrôle et graissage de la béquille centrale et latérale

Périodiquement, toujours vérifier le fonctionnement de la béquille centrale et latérale, et lubrifier les axes de guidage (1) et les surfaces de contact métal sur métal si nécessaire.

! AVERTISSEMENT

Si la béquille centrale ou la béquille latérale ne s'actionne pas aisément, faire contrôler ou réparer par un concessionnaire *Italjet*.

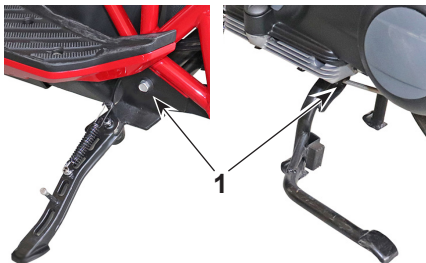

5.1.q Réglage de la précharge du ressort des amortisseurs

Les amortisseurs avant (1) et arrière (2) ont la possibilité de régler la précharge du ressort ; pour ce faire, desserrer le contre-bague (3) et tourner la bague (4), en la serrant pour augmenter la précharge et inversement pour la diminuer.

En vissant la bague, le ressort est comprimé et donc une action d'amortissement plus rigide est obtenue.

Le dévissage de la bague libère le ressort et vous aurez donc une action d'amortissement plus douce.

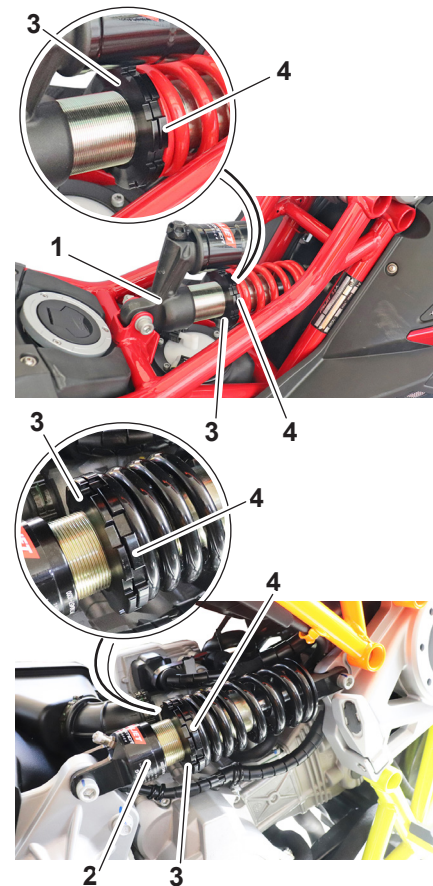



5.1.r Réglage freinage amortisseur avant

- Régler le freinage en tournant la bague (1) : vers « + » le freinage augmente, vers « - » le freinage diminue.

Le réglage d'usine est de 6 clics à partir du blocage complet.

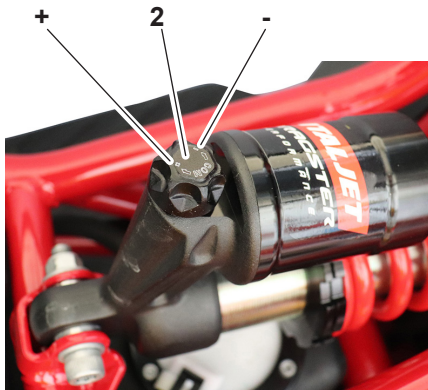

5.1.s Vérification colonne de direction avant

Périodiquement, tout jeu dans la colonne de direction doit être vérifié.

- Placer la moto sur la béquille centrale, une personne doit tenir le guidon de la moto pour qu'il soit stable et une autre personne doit essayer de déplacer la roue (1) dans le sens de la flèche "A" et dans le sens de la flèche "B".



En cas de jeu excessif, contacter un revendeur **Italjet** pour vérifier le comportement de la direction (2).

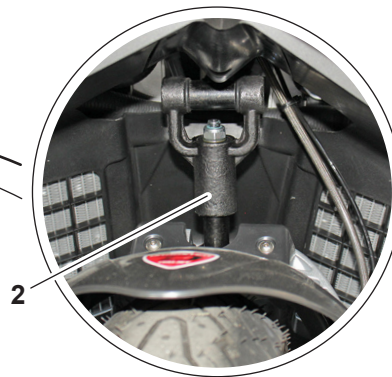



5.1.t Vérification et charge batterie

Pour accéder au compartiment de la batterie, procédez comme suit :

- Soulever la selle comme décrit dans le paragraphe correspondant ;
- Dévisser les deux vis (1) et retirer la selle passager (2) ;

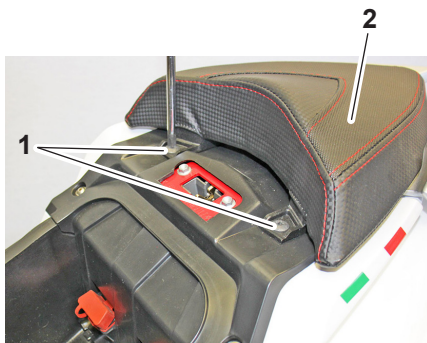

- Dévisser les deux vis (3) et retirer le carter (4).



- Retirer d'abord le câble négatif NOIR (5) puis le câble positif ROUGE (6) (au remontage, brancher d'abord le câble positif ROUGE, puis le câble négatif NOIR) ;
- Retirer la batterie (7) de son logement.

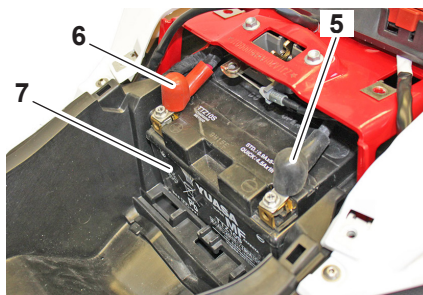

- Vérifiez, à l'aide d'un voltmètre, que la tension de celui-ci n'est pas inférieure à 12,5V. Sinon, la batterie a besoin d'un cycle de recharge.

- À l'aide d'un chargeur de batterie à tension constante, connectez d'abord le câble positif ROUGE au pôle positif de la batterie puis le négatif NOIR au pôle négatif de celle-ci.

- Vérifiez toujours l'état de charge de la batterie avant de la réinstaller sur le véhicule. La batterie doit être maintenue propre et les pôles graissés.

>>>





- Remonter le tout en procédant dans l'ordre inverse du démontage en prenant soin d'emboîter le crochet (8) de la selle passager dans l'assise (9) du support.

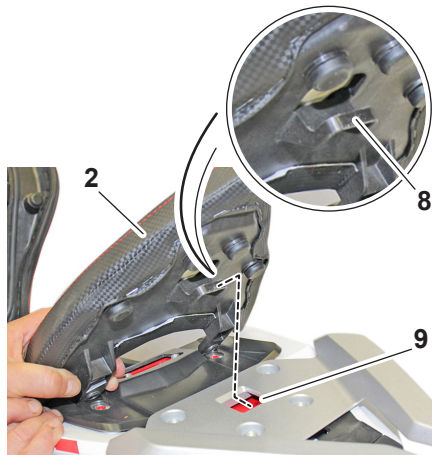

! DANGER

La batterie contient de l'acide sulfurique. Éviter le contact avec la peau, les yeux et les vêtements.

REMÈDES : **CONTACT AVEC LA PEAU**

Rincer abondamment à l'eau.

INGESTION :

Buvez de grandes quantités d'eau et de lait.

Appelez un médecin immédiatement.

Ne pas faire vomir.

LENTILLES DE CONTACT :

Rincer à l'eau pendant au moins 15 minutes et appeler un médecin.

ATTENTION

Si la batterie n'est pas utilisée, elle doit dans tous les cas être rechargée avec un cycle de charge lent (0,6 A

pendant 8 heures pour une batterie 12V-6Ah) au moins toutes les 3 semaines.

! ATTENTION

Les batteries produisent des gaz explosifs, ventilez la pièce lorsque vous chargez la batterie à l'intérieur. Lorsque vous utilisez un chargeur de batterie, connectez la batterie au chargeur avant de l'allumer. Cette pratique évite la formation d'étincelles aux pôles de la batterie qui pourraient enflammer les gaz contenus dans la batterie.



5.1.u Contrôle / remplacement des fusibles

La moto est équipée de deux boîtes à fusibles, l'une située sous la selle et l'autre située sous le panneau avant.

Fusibles sous le siège

- Soulever la selle pour accéder à la boîte à fusibles (1).

Fusible 2 (20 A) = moteur ABS

Fusible 3 (15 A) = valve ABS

Fusible 4 (10 A) = Positif, tableau de bord, régulateur de tension, injection

Fusible 5 (20 A) = Fusible de recharge

Fusible 6 (15 A) = Fusible de recharge

Fusibles sous le panneau avant

- Dévisser les vis (1) et retirer le panneau supérieur (2).



- Tirez légèrement le panneau (3) vers l'extérieur pour le dégager par le haut.



- Prendre le panneau (3) à deux mains et le tirer vers l'extérieur jusqu'à ce qu'il se dégage du support.

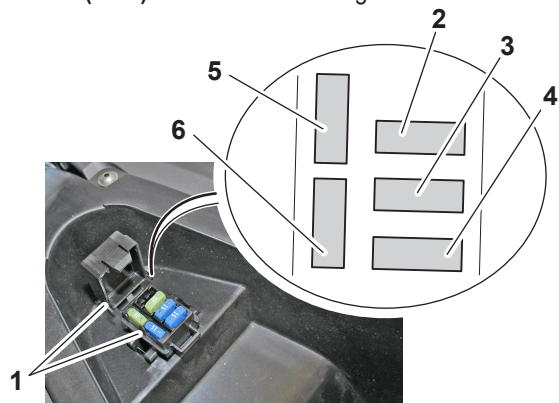
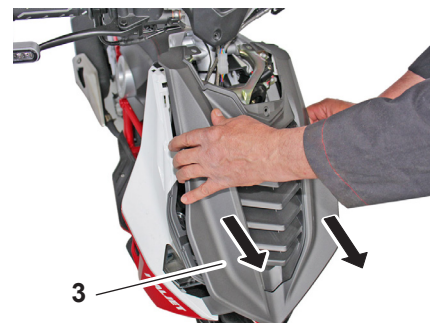



- La boîte à fusibles (4) est située dans la partie supérieure droite de la moto.

Fusible 5 (15A) = Feux, éclairage de plaque d'immatriculation, relais clignotant, klaxon

Fusible 6 (15A) = Injection, démarreur

Fusible 7 (15A) = Fusible de rechange

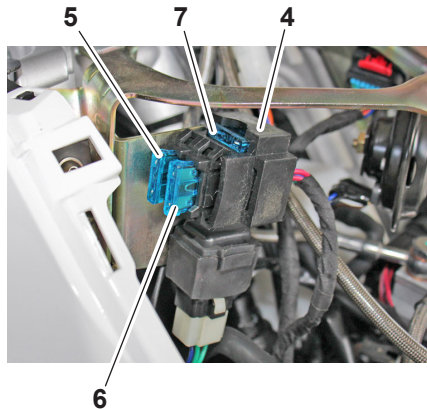

- Remonter le tout en procédant dans l'ordre inverse du démontage, en prenant soin de remettre les butées (8) du panneau (3) dans leurs logements (9).

ATTENTION
N'utilisez pas de fusible avec un ampérage supérieur à celui d'origine, cela pourrait endommager le système

électrique et provoquer un incendie.

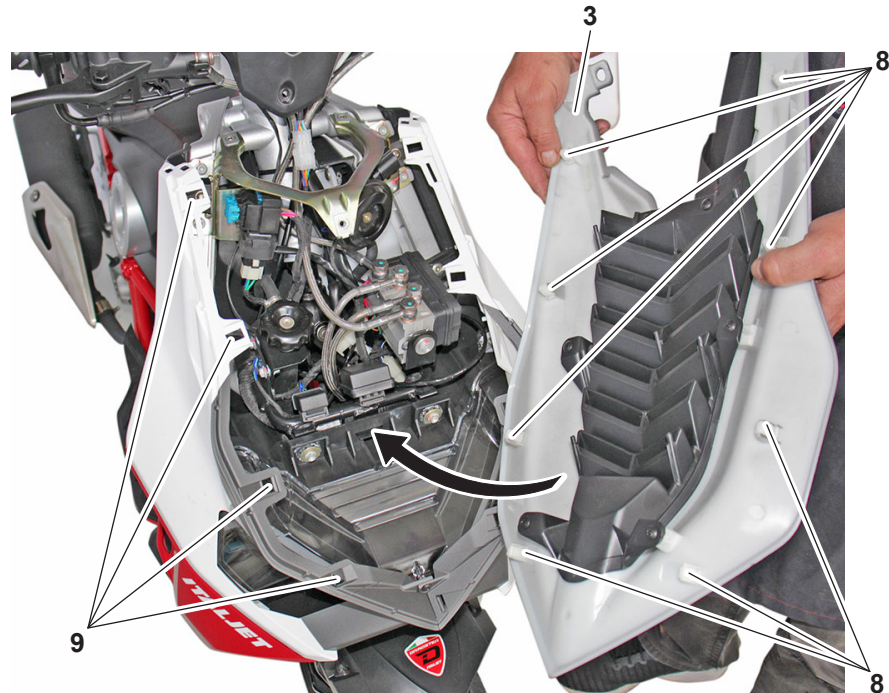



5.1.v Commande d'éclairage

Contrôle du faisceau lumineux avant

- Pour vérifier si le feu est correctement orienté, placez la moto, avec les pneus gonflés à la bonne pression et avec une personne assise en selle, parfaitement perpendiculaire à son axe longitudinal.
- Devant un mur ou un écran, à 10 mètres de celui-ci, tracez une ligne horizontale correspondant à la hauteur du centre du feu et une ligne verticale alignée avec l'axe longitudinal du véhicule.

- Effectuer le contrôle si possible dans la pénombre.
- En allumant les feux de route, la limite supérieure de démarcation entre la zone sombre et la zone éclairée doit être à une hauteur n'excédant pas $\frac{9}{10}X$ de la hauteur depuis le sol du centre du projecteur.
- Pour effectuer le bon réglage, s'adresser à un revendeur **Italjet**.

Feux et indicateurs de direction

- La moto est équipée de feux et clignotants à LED, si un feu ne fonctionne pas il faut le remplacer en se rendant chez le concessionnaire **Italjet**.

Connecteurs de diagnostic

Pour accéder aux connecteurs de diagnostic, soulevez la selle.

Connecteur (1) = unité de contrôle ABS

Connecteur (2) = unité de contrôle Moteur

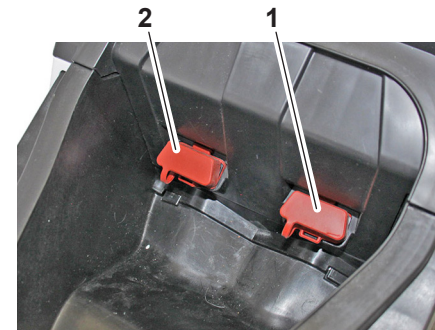
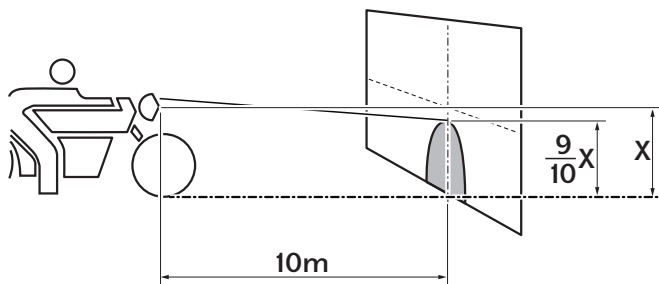



6.1 ENTRETIEN ET STOCKAGE DE LA MOTO

6.1.a Soins

Un nettoyage fréquent et approfondi du véhicule, en plus d'améliorer son apparence, améliorera également ses performances globales et prolongera la durée de vie utile de nombreux composants. De plus, le lavage, le nettoyage et le polissage vous permettront d'inspecter plus fréquemment l'état du véhicule. Lavez le véhicule après l'avoir utilisé sous la pluie ou près de la mer, car le sel est corrosif pour les métaux.

NOTER : Les routes dans les zones sujettes à de fortes chutes de neige peuvent être saupoudrées de sel pour les empêcher de geler. Ce sel peut rester sur les routes jusqu'à la fin du printemps, alors lavez le dessous et les composants du châssis après avoir utilisé le véhicule dans de telles zones.

⚠ ATTENTION

Un nettoyage inadéquat peut causer des dommages esthétiques et mécaniques. Ne pas utiliser :

- Nettoyeurs haute pression ou nettoyeurs vapeur. Une pression d'eau excessive pourra provoquer la pénétration d'eau et la détérioration des roulements de roue, des freins, des joints de transmission et des appareils électriques.
- Produits chimiques agressifs, produits de nettoyage abrasifs ou cire sur les composants avec une finition satinée. Les pinceaux peuvent rayer et endommager les finitions satinées ; utilisez uniquement des éponges ou des serviettes douces.

- Serviettes, éponges ou brosses contaminées par des produits de nettoyage abrasifs ou des produits chimiques agressifs, tels que solvants, essence, antirouille, liquide de frein, antigel, etc.



6.1.b Lavage

Avant

1. Garez la moto à l'abri de la lumière directe du soleil et laissez-la refroidir.
Cela empêchera la formation de taches de calcaire.
2. Vérifiez que toutes les fiches, couvercles, connecteurs et éléments de connexion électrique sont correctement installés.
3. Veillez à ne pas laisser d'eau pénétrer à l'intérieur du silencieux.
4. Enlevez la saleté de la route et les taches d'huile avec un dégraissant de qualité et une brosse à poils en plastique ou une éponge.

Pendant

1. Rincez toute trace de dégraissant à l'eau courante. Évitez de pulvériser de l'eau directement dans le silencieux, sur le tableau de bord, dans l'entrée d'air ou à l'intérieur d'autres zones internes, telles que les compartiments de rangement sous la selle.
2. Lavez la moto avec un nettoyant pour voiture de qualité mélangé à de l'eau douce et une éponge douce. Utilisez une brosse à dents usagée ou une brosse à poils en plastique pour nettoyer les endroits difficiles d'accès.

ATTENTION

Si la moto a été exposée au sel, utilisez de l'eau froide. L'eau chaude augmentera les propriétés corrosives du sel.

3. Bien rincer à l'eau claire. Enlevez tous les résidus de détergent ; pourrait être nocif pour les composants en plastique.

Après

1. Séchez complètement la moto.
2. Polir les surfaces chromées, aluminium et inox avec un produit spécifique.
3. Appliquer un spray anti-corrosion sur tous les composants métalliques, y compris les surfaces chromées ou nickelées.

⚠ ATTENTION

N'appliquez pas de sprays à base de silicone ou d'huile sur les selles, les poignées, les supports de repose-pieds en caoutchouc, les disques de frein ou les bandes de roulement des pneus. Sinon, les composants deviendront glissants, ce qui pourrait vous faire perdre le contrôle du véhicule. Nettoyez soigneusement les surfaces de ces composants avant d'utiliser le véhicule.



4. Traitez les composants en caoutchouc, vinyle et plastique non peints avec un produit d'entretien approprié.
5. Étalez une cire non abrasive sur toutes les surfaces peintes.
6. Après le nettoyage, démarrez le moteur et laissez-le tourner au ralenti pendant quelques minutes pour sécher l'humidité résiduelle.
7. Laissez le véhicule sécher complètement avant de le ranger ou de le couvrir.

ATTENTION

Des saletés s laissées sur les freins ou les pneus peuvent vous faire perdre le contrôle du véhicule.

- **Assurez-vous qu'il n'y a pas de lubrifiant ou de cire sur les freins ou les pneus.**
- **Si nécessaire, laver les pneus avec de l'eau tiède et un détergent neutre.**
- **Si nécessaire, nettoyez les disques et plaquettes de frein avec un spray nettoyant spécial.**
- **Après avoir lavé la moto, tester l'efficacité des freins.**

6.1.c Stockage

Rangez toujours le véhicule dans un endroit frais et sec. Si nécessaire, protégez-le de la poussière en le recouvrant d'une feuille perméable. Assurez-vous que le moteur et le système d'échappement ont refroidi avant de couvrir la moto.

ATTENTION

Pour éviter la corrosion, évitez les sous-sols humides, les abris pour animaux (en raison de la présence d'ammoniac) et les environnements où des produits chimiques puissants sont stockés.



6.1.d Stockage prolongé

Avant de ranger le véhicule pendant une période prolongée (60 jours ou plus), procédez comme suit :

1. Effectuez les travaux d'entretien.
2. Nettoyez la moto.
3. Remplissez le réservoir de carburant en ajoutant du stabilisateur de carburant conformément aux instructions du produit.
Faites tourner le moteur pendant 5 minutes pour répartir le carburant traité dans tout le système de carburant.
4. Lubrifiez la béquille latérale (le cas échéant) et la béquille centrale.
5. Vérifiez et restaurez la pression des pneus, puis soulevez le véhicule de manière que les roues ne touchent pas le sol.
6. Couvrir le silencieux avec un sac en plastique pour empêcher l'humidité de pénétrer.
7. Retirez la batterie et chargez-la complètement, ou connectez un chargeur de maintenance pour maintenir une charge optimale de la batterie.

ATTENTION

Vérifiez que la batterie et son chargeur sont compatibles.

NOTER : Si la batterie doit être retirée, chargez-la une fois par mois et stockez-la dans un endroit tempéré où la température est de 0-30 °C (32-90 °F).



7.1 DONNÉES TECHNIQUES

Longueur maximale	1885 mm
Largeur maximale	750 mm
Hauteur maximum	1075 mm
Hauteur de selle	760 mm
Empattement	1350 mm
Hauteur minimale du sol	120 mm
Poids à vide (poids à vide)	150 kg
Charge maximale du véhicule (conducteur + passager + bagages)	305 kg
Vitesse maxi	124 km/h
Huile moteur	1300 cm ³ (Premier remplissage) 1250 cm ³ (Remplacer l'huile moteur et le filtre) 1200 cm ³ (Ne changer que l'huile moteur)
Huile de transmission	250 cm ³
Réfrigérant	1.15 l (50 % eau + 50 % éthylène glycol liquide antigel)
Places	2
Boite de vitesse	variateur automatique continu
Transmission	ralentisseur et courroie
Type de cadre	Châssis tubulaire en acier haute résistance, monopoutre avant, double berceau arrière à chevauchement.
Angle de braquage	27.5°

>>>>>





Suspension avant	Système de direction indépendant
Débattement de la suspension avant	33 mm
Suspension arrière	Amortisseur mono
Débattement de la suspension arrière	47 mm
Disque avant	Frein à disque Ø 200 mm avec transmission hydraulique
Disque arrière	Frein à disque Ø 220 mm avec transmission hydraulique
Jantes	Jantes en alliage léger
Jante de roue avant	MT 3.50 x 12"
Jante de roue arrière	MT 4.00 x 13"
Type de pneu	Sans chambre à air (Tubeless)
Pneu avant	120/70 - 12" 51 P (120/70-12 M/C, 58S)
Pneu arrière	140/60-13" M/C 63P (140/60-13 M/C 63S)
Pression de gonflage des pneus avant standard	190 kPa (1.9 bar)
Pression de gonflage des pneus arrière standard	200 kPa (2.0 bar)
Pression de gonflage des pneus avant standard avec passager	210 kPa (2.1 bar)
Pression de gonflage des pneus arrière standard avec passager	250 kPa (2.5 bar)
Batterie	12V - 8.6Ah
Fusibles	20 - 15 - 15 - 15 - 15 - 10 A
Alternateur (type aimant permanent)	12 V - 300W a 8000 rpm



Données techniques du moteur (300CC)

Sigle Moteur	AZC
Type de moteur	Monocylindre à 4 temps refroidi par liquide, 4 soupapes par cylindre avec un unique arbre à cames en tête
Puissance nette max.	17 kW (8000 r/min)
Couple maxi	23 N•m (6000 r/min)
Cylindrée	278 cc
Alésage / course	75 mm x 63 mm
Ratio de compression	11 : 1
Allumage	Électrique
Régime de ralenti	1700 ± 170 rpm
Embrayage	Embrayage à sec centrifuge automatique
Boite de vitesse	Automatique
Refroidissement	Système de refroidissement liquide avec radiateur et ventilateur électrique
Système d'alimentation	Injection électronique
Diamètre alimentation	Ø 32 mm
Carburant	Essence super sans plomb, indice d'octane minimum de 95 (NORM)
Type d'allumage	Électronique
Bougie	NGK CR8EKB





8.1 TABLEAU DES PRODUITS RECOMMANDÉS

<i>Produit</i>	<i>Description</i>	<i>Caractéristiques</i>
Huile moteur semi-synthétique ou synthétique	Huile moteur	SAE 5W-40 JASO MA, MA2 API SL ACEA A3
Huile moteur semi-synthétique ou synthétique	Huile transmission	SAE 80W/90 75W/90 GL-4 / GL-5
Lubrifiant L-XCDBB2	Graisse au lithium avec molybdène pour roulements et autres points nécessitant une lubrification	NLGI 2
Liquide de frein FMVSS DOT4	Liquide de frein	FMVSS DOT4
Liquide de refroidissement FD-2B	Liquide de refroidissement O.A.T. technology	Protection antigel jusqu'à -40°C. Conforme à la norme CUNA 956-16.
Lubrifiant / Huile moteur 5W-30	Huile éponge filtre à air	-
GRAISSE NEUTRE OU PÉTROLÉE	Pôles de batterie	-



FR - 70





9.1 CARNET DE GARANTIE ET DE SERVICE

FR - 71





9.1.a Le contenu de la garantie

Votre nouvelle moto est garantie exempte de défauts d'origine conformément à la **Directive 99/44 CE**.

La garantie consiste en le remplacement ou la réparation gratuit du véhicule ou des composants qui présentent, dans le délai susvisé, des défauts de fabrication ou, en tout état de cause, des défauts préexistants à la livraison du véhicule.

La garantie n'est valable que si votre véhicule a suivi le programme d'entretien recommandé et que tous les coupons ont été correctement estampés.

Nous vous rappelons que la garantie ne s'applique pas en cas d'utilisation du véhicule en compétition moto, car il s'agit d'un usage différent et non compatible avec l'usage pour lequel votre véhicule a été spécifiquement conçu. N'oubliez pas que, comme l'exige la loi, cette garantie est fournie directement par votre concessionnaire **Italjet**, auquel nous vous invitons à vous adresser pour tout besoin.

Si votre concessionnaire Italjet ne peut pas satisfaire vos demandes dans un délai raisonnable ou si cela vous convient mieux, nous vous invitons à contacter tout autre concessionnaire **Italjet**, qui se fera un plaisir d'être à votre service.

9.1.b Activation de la garantie

Votre véhicule est couvert par une garantie contre les défauts d'origine à partir du moment où il vous est livré par votre Concessionnaire **Italjet**.

Lorsque vous recevez votre véhicule **Italjet**, nous vous invitons à signer, avec le Concessionnaire, le Certificat de Livraison du Véhicule qui se trouve dans ce manuel.

9.1.c Que faire en cas de réclamation sous garantie

Dans le cas où, pendant la période de garantie, votre véhicule nécessite une réparation et/ou un remplacement extraordinaire en raison d'un défaut d'origine, nous vous conseillons de contacter immédiatement le Concessionnaire où vous avez acheté le véhicule (votre Concessionnaire) en lui décrivant le problème survenu et en lui faisant examiner le véhicule.

Si l'intervention est rendue nécessaire par la survenance d'un défaut d'origine, votre Concessionnaire effectuera gratuitement la réparation ou le remplacement nécessaire dans les plus brefs délais.

9.1.d Conditions de garantie

Exclusions

Sont exclus de la garantie :

- Détérioration résultant du non-respect du plan d'entretien périodique prescrit par Italjet.
- Véhicules dont les réparations ont été effectuées avec des pièces détachées non conformes à l'original.
- Véhicules pour lesquels le plan d'entretien périodique n'a pas été effectué ou pour lesquels les coupons n'ont pas été dûment estampillés.
- Véhicules utilisés pour la course / location / utilisation intensive hors route.

Consommables et pièces d'usure :

La garantie ne couvre pas l'usure normale causée par l'utilisation du véhicule pour les pièces suivantes :

- Bougies.
- Chaîne de distribution.
- Plaquettes et disques de frein.
- Disques et masses d'embrayage.
- Pneus.
- Lampes et fusibles.
- Câbles de transmission et de commande.
- Tubes et toutes autres pièces en caoutchouc.
- Roulements.
- Filtre à air et à essence.
- Courroie et engrenages d'entraînement secondaire.



Lubrifiants

La garantie ne couvre pas les liquides: huile, graisse, acide de batterie et liquide de refroidissement.

Limites

Pour tous les véhicules : la garantie de la BATTERIE, du SIÈGE et des PLASTIQUES est limitée à 6 mois.

- La garantie ne couvre pas les frais d'entretien et de révision, ni le coût des pièces nécessaires à ces opérations.
- La garantie ne couvre pas les frais résultants de la demande de garantie tels que : les frais supplémentaires de communications, de chambre et de pension éventuels, ni les autres frais dérivés tels que l'indemnisation du temps perdu, les pertes commerciales, les frais de location de véhicule de remplacement, le transport.

Remarque importante pour la validité de la garantie :

- Le livret de garantie doit être conservé avec soin et doit être présenté au concessionnaire officiel **Italjet** à chaque intervention.
- Les coupons de contrôle doivent être remplis par le Concessionnaire qui a effectué l'intervention.
- La garantie peut être transférée aux propriétaires ultérieurs jusqu'à son échéance.
- En cas de changement de propriétaire, utilisez le coupon spécial présent dans ce livret.
- Le constructeur se réserve le droit d'apporter des modifications et/ou améliorations sur tous ses modèles sans obligation d'apporter ces modifications sur les véhicules déjà en circulation.





Area with horizontal dotted lines for text entry.



FR - 74





CERTIFICAT DE LIVRAISON

Date :

Numéro de cadre :

Modèle :

Numéro de moteur :

La moto a été préparée pour la livraison en effectuant tous les contrôles et opérations préalables à la livraison prévus par ITALJET S.P.A. et complété par tous les accessoires optionnels demandés par le Client.

Le client a reçu ce livret de garantie et le manuel d'utilisation et d'entretien et les principaux dispositifs de conduite fournis avec le véhicule ont été illustrés.

Cachet et signature du revendeur

L'organisation commerciale officielle et la société ITALJET SPA déclarent que le traitement des données personnelles de l'acheteur, en référence à la loi n° 675 de 1996 et ses modifications ultérieures, peut également avoir lieu sans le consentement du client, en exécution de l'obligation de fournir le Service d'assistance.



CLIENT

Prénom: _____

Nom: _____

Adresse: _____

Ville: _____

CAP: _____

Numéro de téléphone: _____

Je déclare recevoir aujourd'hui la moto indiquée ci-dessus complète et conforme à mes attentes, et je déclare recevoir ce Livret de Garantie et le Manuel d'utilisation et d'entretien. J'autorise ITALJET S.P.A. au traitement de mes données personnelles dans le but de fournir le service d'assistance conformément à la loi 675/1996 et ses modifications ultérieures.

Signature du client

Copie pour ITALJET S.P.A.

FR - 75



Area with horizontal dotted lines for text entry.



FR - 76





COMMUNICATION DE TRANSFERT DE PROPRIÉTÉ

Date: Km:

Numéro de cadre :

Modèle:

Numéro de moteur :

Il sottoscritto : _____

Prénom: _____

Nom: _____

Adresse: _____

Adresse: _____ CAP: _____

Numéro de téléphone: _____

Envoyer sous enveloppe scellée à :
ITALJET S.P.A. , Via dell'agricoltura, 2 - 40023 Castel Guelfo di Bologna (BO) - Italie

L'organisation commerciale officielle et la société ITALJET SPA déclarent que le traitement des données personnelles de l'acheteur, en référence à la loi n° 675 de 1996 et ses modifications ultérieures, peut également avoir lieu sans le consentement du client, en application de l'obligation de fournir le Service d'assistance.



CLIENT



Communique ITALJET S.P.A. qui a aujourd'hui transféré la propriété du véhicule susmentionné à M.

Prénom: _____

Nom: _____

Adresse: _____

Ville: _____

CAP: _____

Numéro de téléphone: _____

Expédier ce livret de garantie et le manuel d'utilisation et d'entretien fournis.

Copie pour ITALJET S.P.A.

FR - 77





A series of 12 horizontal dotted lines, evenly spaced, intended for text entry.



FR - 78





Espace pour conservation documentation prouvant l'exécution des coupons d'entretien programmé.



COUPON	<input type="text"/>	DATE	<input type="text"/>	Km	<input type="text"/>	Signature du client	<input type="text"/>	Tampon du concessionnaire	<input type="text"/>
COUPON	<input type="text"/>	DATE	<input type="text"/>	Km	<input type="text"/>	Signature du client	<input type="text"/>	Tampon du concessionnaire	<input type="text"/>
COUPON	<input type="text"/>	DATE	<input type="text"/>	Km	<input type="text"/>	Signature du client	<input type="text"/>	Tampon du concessionnaire	<input type="text"/>
COUPON	<input type="text"/>	DATE	<input type="text"/>	Km	<input type="text"/>	Signature du client	<input type="text"/>	Tampon du concessionnaire	<input type="text"/>
COUPON	<input type="text"/>	DATE	<input type="text"/>	Km	<input type="text"/>	Signature du client	<input type="text"/>	Tampon du concessionnaire	<input type="text"/>
COUPON	<input type="text"/>	DATE	<input type="text"/>	Km	<input type="text"/>	Signature du client	<input type="text"/>	Tampon du concessionnaire	<input type="text"/>
COUPON	<input type="text"/>	DATE	<input type="text"/>	Km	<input type="text"/>	Signature du client	<input type="text"/>	Tampon du concessionnaire	<input type="text"/>
COUPON	<input type="text"/>	DATE	<input type="text"/>	Km	<input type="text"/>	Signature du client	<input type="text"/>	Tampon du concessionnaire	<input type="text"/>
COUPON	<input type="text"/>	DATE	<input type="text"/>	Km	<input type="text"/>	Signature du client	<input type="text"/>	Tampon du concessionnaire	<input type="text"/>
COUPON	<input type="text"/>	DATE	<input type="text"/>	Km	<input type="text"/>	Signature du client	<input type="text"/>	Tampon du concessionnaire	<input type="text"/>

FIXER avec un trombone ou une agrafeuse le Reçu qui certifie que les coupons d'entretien ont été effectués.







ES

Español

Italjet declina cualquier responsabilidad por cualquier error que pueda haber ocurrido en la compilación de este manual y se reserva el derecho de realizar cualquier cambio requerido por el desarrollo evolutivo de sus productos. Las ilustraciones mostradas son indicativas y pueden no corresponder exactamente con el tratado en particular. Incluso la reproducción parcial de esta publicación está prohibida sin autorización por escrito.





DRAGSTER

A large, stylized red letter 'D' with a white outline, positioned below the word 'DRAGSTER'. The 'D' has a thick, rounded shape with a white cutout in the middle.

ES - 2





ÍNDICE

1.1 PRESENTACIÓN.....	ES - 5	2.4.b Instrumento digital.....	ES - 17	2.13.b Convertidor catalítico ...	ES - 26
1.2 ADVERTENCIAS	ES - 5	2.5 AJUSTE Y CONFIGURACIÓN		2.14 ACCESORIOS Y TOMA	
IMPORTANTES	ES - 5	DE PANTALLA	ES - 18	USB	ES - 26
1.3 SÍMBOLOS PRESENTES		2.6 COMANDOS.....	ES - 19	2.14.a Per utilizzare la toma	
EN EL MANUAL	ES - 6	2.6.a Bloqueo de teclas	ES - 19	USB	ES - 26
1.4 CONDUCCIÓN SEGURA Y		2.6.b "Lock" bloqueo de la		2.14.b Compartimento de	ES - 27
SEGURIDAD DE LA		dirección.....	ES - 20	almacenamiento	
MOTOCICLETA.....	ES - 7	2.7 BLOQUE DE CONTROL		debajo del sillín	ES - 27
1.5 SISTEMA ANTIBLOQUEO		IZQUIERDO.....	ES - 21	2.14.c Caballete lateral	ES - 28
DE FRENOS – ABS	ES - 8	2.8 BLOQUE DE CONTROL		2.14.d Caballete central	ES - 29
1.6 RIESGOS RELACIONADOS		DERECHO.....	ES - 22	3.1 COMPROBACIONES ANTES	
CON EL MONÓXIDO		2.8.a Interruptor de		DEL USO.....	ES - 30
DE CARBONO	ES - 8	EMERGENCIA		3.2 INSTRUCCIONES PARA EL	
1.7 INFORMACIÓN DE		de parada del motor	ES - 22	USO DE LA MOTOCICLETA.....	ES - 32
SEGURIDAD	ES - 9	2.8.b Botón de arranque del		3.2.a Instrucciones de	
1.7.a Accesorios.....	ES - 9	motor	ES - 22	rodaje	ES - 32
1.7.b Transporte del scooter	ES - 9	2.9 CONTROL DEL		3.2.b Identificación de	
1.7.c Llave plegable	ES - 9	ACELERADOR.....	ES - 22	problemas operativos ...	ES - 32
2.1 COMPONENTES DEL		2.10 CONTROL DE FRENO		3.3 ASCENSO / DESCENSO DEL	
SCOOTER.....	ES - 10	DELANTERO.....	ES - 23	CONDUCTOR Y PASAJERO....	ES - 33
2.2 CONTROLES E		2.11 CONTROL DE FRENO		3.3.a Reglas generales	ES - 33
INSTRUMENTOS	ES - 13	TRASERO	ES - 23	3.3.b Ascenso del	
2.3 DATOS DE		2.12 TANQUE DE GASOLINA	ES - 24	conductor	ES - 33
IDENTIFICACIÓN	ES - 14	2.12.a Repostaje	ES - 24	3.3.c Ascenso del pasajero....	ES - 34
2.4 INSTRUMENTACIÓN.....	ES - 15	2.13 COMBUSTIBLE.....	ES - 25	3.3.d Descenso de la	
2.4.a Luces indicadoras y de		2.13.a Diferentes tipos de		motocicleta	ES - 35
advertencia.....	ES - 15	gasolina	ES - 25		





3.4 AJUSTE DE LOS ESPEJOS RETROVISORES ES - 35

4.1 ARRANQUE DE LA MOTOCICLETA ES - 36

4.1.a Uso del acelerador ES - 37

4.1.b Uso de los frenos ES - 37

4.1.c Parada de la motocicleta y el motor ... ES - 38

4.1.d Parada del motor en caso de emergencia..... ES - 38

4.1.e Estacionamiento de la motocicleta ES - 38

5.1 MANTENIMIENTO Y CONTROLES PERIÓDICOS..... ES - 39

5.1.a Mantenimiento periódico..... ES - 39

5.1.b Comprobación del nivel de aceite..... ES - 43

5.1.c Reemplazo del filtro y aceite del motor..... ES - 43

5.1.d Comprobación del nivel de refrigerante ES - 46

5.1.e Limpieza del filtro de aire del motor ES - 46

5.1.f Limpieza del filtro de aire de la transmisión ES - 48

5.1.g Comprobación de

la bujía..... ES - 49

5.1.h Comprobación neumáticos y presión relativa ES - 49

5.1.i Inspección de neumáticos..... ES - 50

5.1.l Comprobación del desgaste de las pastillas de freno ES - 51

5.1.m Comprobación del nivel de líquido de frenos delantero / trasero ES - 53

5.1.n Cambio del líquido de frenos ES - 54

5.1.o Comprobación de la correa trapezoidal ES - 54

5.1.p Comprobación y lubricación del caballete central y lateral..... ES - 55

5.1.q Ajuste de la precarga del resorte del amortiguador ES - 55

5.1.r Ajuste frenado amortiguador delantero ES - 56

5.1.s Comprobación de la columna de dirección delantera ES - 56

5.1.t Comprobación y carga de la batería ES - 57

5.1.u Comprobación / sustitución de fusible ES - 59

5.1.v Control de iluminación... ES - 61

6.1 MANTENIMIENTO Y ALMACENAMIENTO DE LA MOTOCICLETA ES - 62

6.1.a Mantenimiento..... ES - 62

6.1.b Lavado ES - 63

6.1.c Almacenamiento ES - 64

6.1.d Almacenamiento prolongado ES - 65

7.1 DATOS TÉCNICOS ES - 66

8.1 TABLA DE PRODUCTOS RECOMENDADO ES - 69

9.1 LIBRO DE GARANTÍA Y SERVICIO ES - 71

9.1.a El contenido de la garantía ES - 72

9.1.b Activación de la garantía ES - 72

9.1.c Qué hacer en caso de reclamación de garantía ES - 72

9.1.d Condiciones de garantía ES - 72





1.1 PRESENTACIÓN

¡Bienvenido a la familia de motocicletas **Italjet!**

Su scooter **Italjet** ha sido diseñado y fabricado para ser el mejor de su categoría. Las instrucciones de este manual se han preparado para proporcionar una guía sencilla y clara para el uso y mantenimiento de la motocicleta. Para obtener el mejor rendimiento de él, se recomienda seguir cuidadosamente las instrucciones dadas en este manual. Contiene instrucciones para realizar las operaciones de mantenimiento necesarias. Las reparaciones o el mantenimiento más específicos o importantes requieren el trabajo de mecánicos expertos y el uso de equipos adecuados. Es recomendable ponerse en contacto con la Red Oficial **Italjet** que cuenta con todas las herramientas para ofrecer el mejor servicio al Cliente.

ATENCIÓN

Por último, recuerde que el "Manual de uso y mantenimiento" debe considerarse **parte integrante de la motocicleta y como tal permanecerá adjunto a la misma incluso en caso de reventa.**

Esta motocicleta utiliza componentes diseñados y fabricados con sistemas y tecnologías de vanguardia.

Para el correcto funcionamiento de la motocicleta, es necesario seguir la tabla de inspección y mantenimiento que se proporciona en este manual.



1.2 ADVERTENCIAS IMPORTANTES

Los modelos **DRAGSTER** son motocicletas para uso en CARRETERA, cubiertas por una garantía contractual, siempre que SE MANTENGA LA CONFIGURACIÓN ESTÁNDAR y se respeten las intervenciones de mantenimiento.



1.3 SÍMBOLOS PRESENTES EN EL MANUAL

La información particularmente importante se resalta con los siguientes símbolos.

 PELIGRO	PELIGRO se utiliza para llamar la atención sobre los posibles riesgos de lesiones. Obedezca todos los mensajes de seguridad que siguen a este símbolo para evitar lesiones o la muerte.
 ADVERTENCIA	ADVERTENCIA indica una situación peligrosa que, si no se evita, podría provocar la muerte o lesiones graves.
 ATENCIÓN	PRECAUCIÓN indica precauciones especiales que se deben tomar para evitar daños al vehículo.
NOTA	<i>NOTA</i> contiene información importante sobre el tema.



1.4 CONDUCCIÓN SEGU- RA Y SEGURIDAD DE LA MOTOCICLETA

A continuación, enumeramos algunos principios básicos para una conducción segura de su scooter.

- Recuerde que su seguridad y la seguridad del pasajero es lo primero. Llegar con seguridad al final del viaje debe ser el principal objetivo.
- El piloto y el pasajero deben llevar ropa protectora adecuada como mono, guantes, zapatos, casco homologado para uso en motocicleta.
- La posición del ciclista en la motocicleta debe ser tal que tenga la vista más amplia posible de la carretera por la que viaja.
- Conduzca la motocicleta con cuidado, ajuste la velocidad de acuerdo con el tráfico y el tipo de conformación de la carretera. Un viaje suave le permite evaluar los peligros y establecer trayectorias en las curvas con mayor precisión.
- Preste siempre atención a las señales de advertencia y module la velocidad de acuerdo con las indicaciones dadas.
- Respete siempre los límites de velocidad.

- Evaluar siempre el estado de la calzada y modular la velocidad en función de ello.
- Limite su velocidad en caso de lluvia y especialmente en caso de charcos en el asfalto.
- Al conducir sobre superficies mojadas o con poco agarre (nieve, hielo, barro, etc.), mantenga una velocidad moderada, evitando frenadas bruscas y maniobras bruscas.
- Mantenga una distancia segura de los vehículos que se encuentran frente a usted.
- Antes de adelantar, verifique que no haya obstáculos delante del vehículo que debe adelantar y controle siempre por los retrovisores que no haya otros vehículos que se acerquen por detrás.
- Frenar con los frenos delantero y trasero al mismo tiempo: esto ayuda a mantener la estabilidad del vehículo.
- Si se siente cansado o somnoliento, deténgase y descanse. El uso continuo de los frenos cuesta abajo podría hacer que las pastillas de freno se sobrecalienten, limitando la acción de frenado;
- No apague el motor mientras conduce cuesta abajo.
- Cuando viaje con el pasajero, aumente las distancias de seguridad

- con los vehículos que se encuentran frente a usted y tenga en cuenta su peso al frenar y cuando tenga que doblar o adelantar.
- La posición del conductor y del pasajero es importante para el control del vehículo.
- Mientras conduce, el conductor debe mantener ambas manos en el manillar y ambos pies en los reposapiés para mantener el control de la motocicleta.
- El pasajero debe sujetar siempre al conductor o al asa con ambas manos, y mantener ambos pies en los reposapiés. Nunca lleve un pasajero a menos que pueda colocar firmemente ambos pies en sus reposapiés.
- Nunca conduzca bajo los efectos del alcohol o las drogas.
- Este scooter está diseñado solo para uso en carretera. No es apto para uso todoterreno.
- No utilice cordones, cuerdas etc ... para asegurar el equipaje, utilice únicamente bolsas homologadas adecuadas para el tipo de motocicleta que utilice.
- La carga máxima transportable (conductor, pasajero y equipaje) no debe exceder los 155 kg (342 lb.). En ningún caso el peso del equipaje debe exceder los 5 kg (11 lb).





1.5 SISTEMA ANTIBLOQUEO DE FRENOS – ABS

El ABS es un sistema de ayuda al frenado electromecánico:

evita que las ruedas se bloqueen durante el frenado, lo que ayuda a mantener la estabilidad del vehículo en presencia de superficies resbaladizas, mojadas o sucias.

En condiciones de mala adherencia, el sistema puede intervenir ampliando la distancia de frenado (por ejemplo, presencia de grava o superficie resbaladiza), pero en cualquier caso garantiza el espacio mínimo para esa calzada en particular.

- El sistema ABS no funciona a velocidades inferiores a 10 km / h. Cuando, durante el frenado, el sistema entra en funcionamiento, se sienten pulsaciones en la maneta de freno: esta sensación no debe llevar a aflojar la presión sobre la maneta, ya que esto anularía la acción del sistema. Además, la presencia del sistema ABS no debe dar lugar a conductas o conductas de conducción que superen las normas habituales de prudencia.
- Utilice siempre pastillas y neumáticos recomendados para garantizar el correcto funcionamiento del sistema ABS.

1.6 RIESGOS RELACIONADOS CON EL MONÓXIDO DE CARBONO

Los gases de escape contienen monóxido de carbono, un gas incoloro e inodoro. Respirar monóxido de carbono puede provocar pérdida del conocimiento y la muerte.

Si el motor se arranca en habitaciones total o parcialmente cerradas, el aire que respira puede contener una cantidad peligrosa de monóxido de carbono. Nunca arranque la motocicleta en un garaje u otro lugar cerrado.

 **PELIGRO**

El monóxido de carbono es un gas tóxico. Respirarlo puede provocar pérdida del conocimiento y la muerte. Evite las áreas o actividades que puedan exponerlo al monóxido de carbono.



1.7 INFORMACIÓN DE SEGURIDAD

1.7.a Accesorios

Elegir los accesorios adecuados para su vehículo es una decisión importante. Utilice únicamente accesorios originales, disponibles en los distribuidores **Italjet** que hayan sido probados y aprobados para su uso en su vehículo.

La adición de accesorios eléctricos debe realizarse con precaución. Si los accesorios eléctricos exceden la capacidad del sistema eléctrico del scooter, puede ocurrir una falla en el sistema eléctrico.

1.7.b Transporte del scooter

Antes de transportar su scooter a otro vehículo, siga las siguientes instrucciones.

- Retire todos los objetos sueltos del scooter.
- Oriente la rueda delantera en la posición de funcionamiento en línea recta en el remolque o en la plataforma del camión y bloquéela adecuadamente para evitar que se mueva.
- Asegure el scooter con cuerdas adecuadas o correas de anclaje a los componentes sólidos del propio scooter, como el cuadro (y no, por ejemplo, a los indicadores de dirección u otros componentes que puedan romperse). Elija la posición de las correas con cuidado para evitar que rocen contra las piezas pintadas durante el transporte.
- La suspensión, si es posible, debe estar parcialmente comprimida, para que el scooter no se sacuda excesivamente durante el transporte.

1.7.c Llave plegable

La llave (1) del Dragster es plegable. Para evitar que se rompa, se recomienda doblar el mango de la llave (1) perpendicular a la propia llave mientras el vehículo está en movimiento.





2.1 COMPONENTES DEL SCOOTER

Vista lateral derecha

1. Estructuras del conductor
2. Asiento del conductor
3. Asiento del pasajero
4. Asas de pasajero
5. Estructuras pasajero
6. Amortiguador trasero
7. Silenciador de escape
8. Guantero





Vista del lado izquierdo

1. Rueda delantera
2. Disco de freno delantero
3. Pinza de freno delantero
4. Brazo único delantero
5. Amortiguador de un brazo
6. Cerradura de acceso al compartimento debajo del sillín
7. Regulador de voltaje
8. Motor
9. Filtro de aire
10. Caballete central
11. Filtro de aire de transmisión
12. Disco de freno trasero y pinza
13. Rueda trasera
14. Tapón del depósito de combustible
15. Tanque de gasolina
16. Caballete lateral

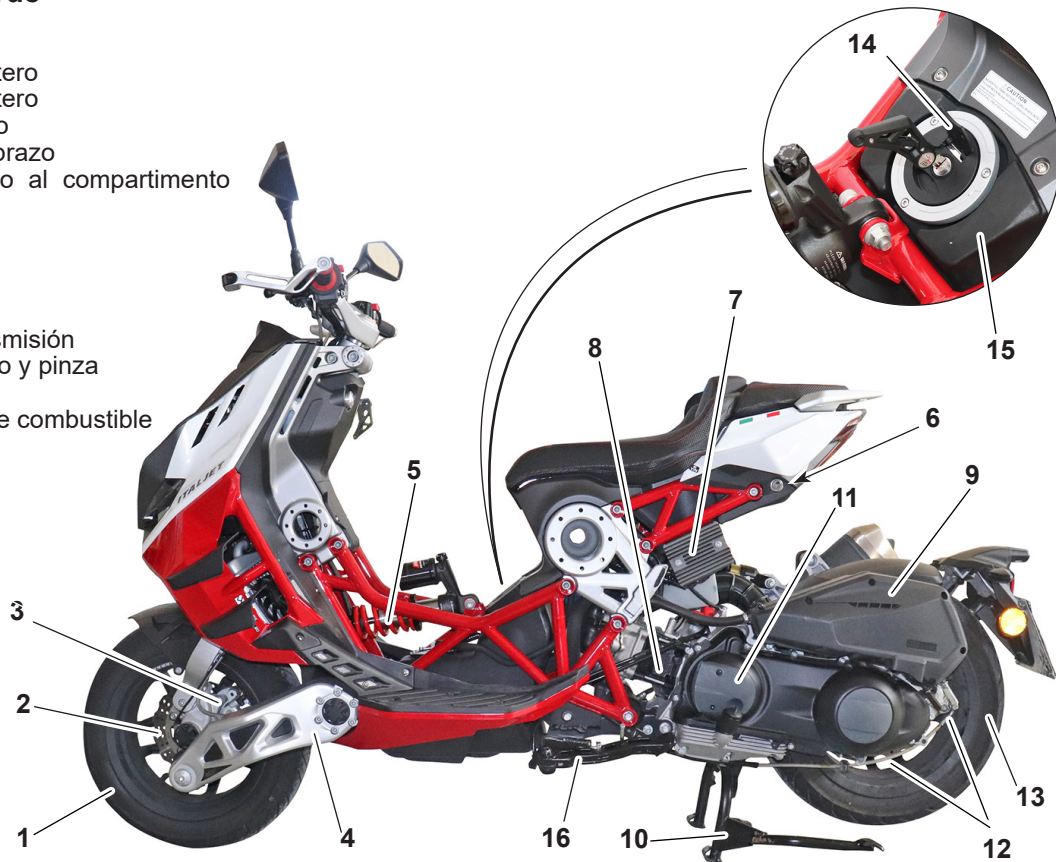



Vista frontal y posterior

1. Espejo retrovisor derecho
2. Espejo retrovisor izquierdo
3. Indicador de dirección derecha
4. Indicador de dirección izquierda
5. Luz delantera
6. Radiador derecho
7. Radiador izquierdo
8. Luz trasera
9. Flecha trasera izquierda
10. Flecha trasera derecha
11. Luz de matrícula
12. Soporte para matrículas

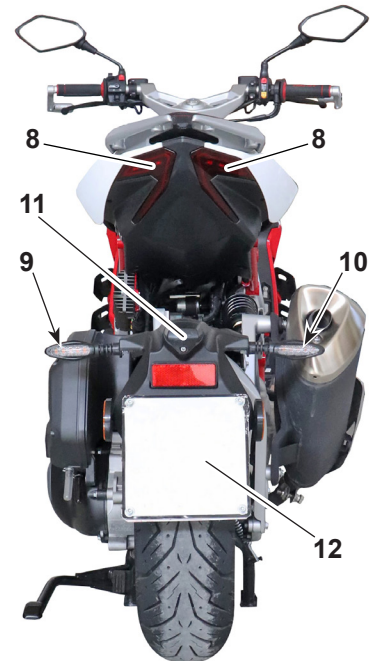



2.2 CONTROLES E INSTRUMENTOS

1. Perilla izquierda
2. Bloque de control izquierdo
3. Palanca del freno trasero
4. Control del acelerador
5. Bloque de control derecho
6. Palanca del freno delantero
7. Interruptor de encendido
8. Toma USB
9. Instrumento digital

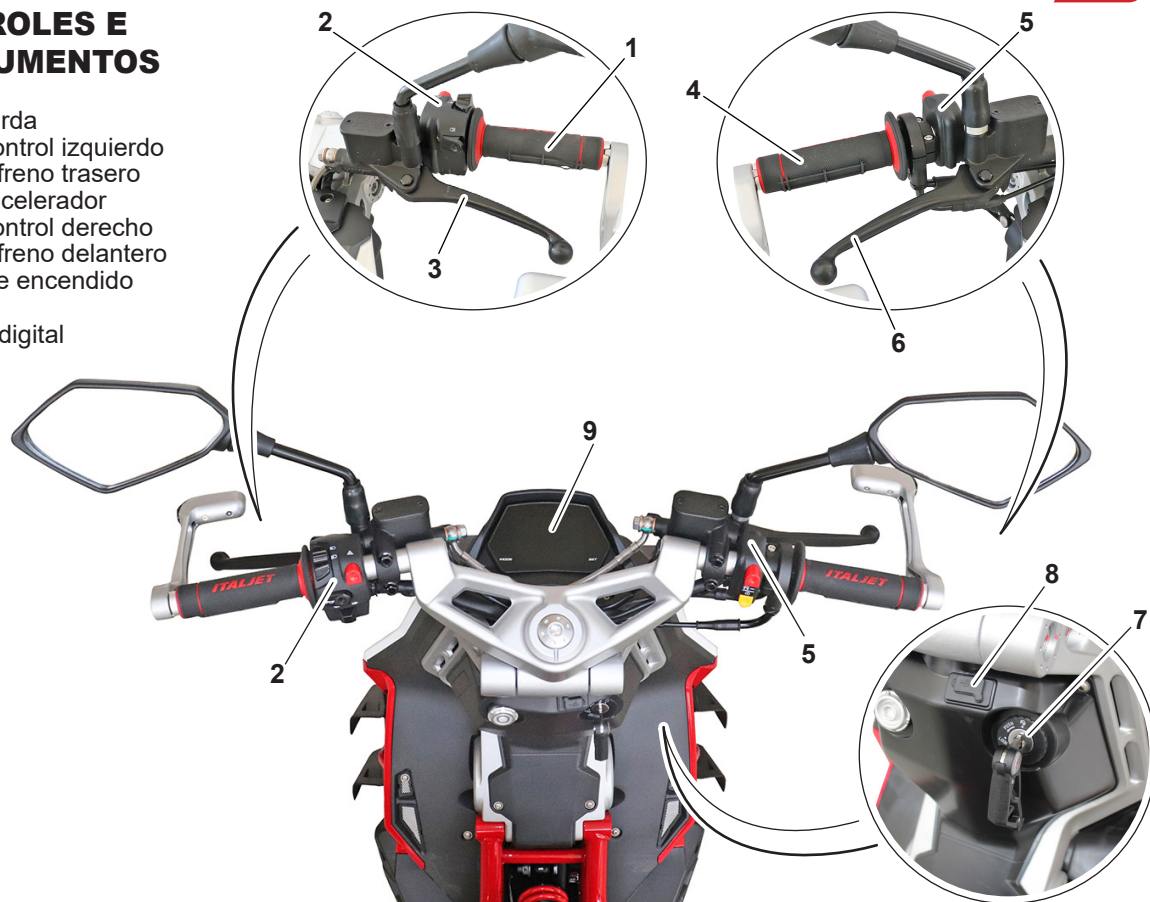



2.3 DATOS DE IDENTIFICACIÓN

El número de identificación del motor está grabado en la parte trasera / superior del cárter, mientras que el número de serie está grabado en el marco debajo del asiento.

Consulte siempre, anotándolo también en este folleto, **el número estampado en el bastidor** cuando solicite piezas de repuesto o solicite información sobre su motocicleta.

NÚMERO DE SERIE DEL MOTOR

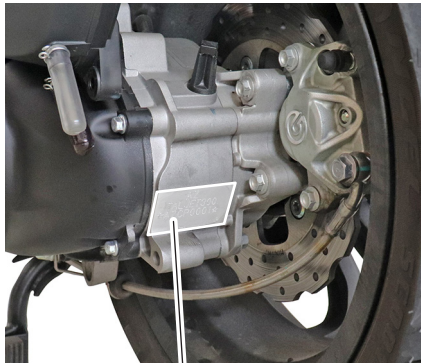

NÚMERO DE SERIE DE LA MOTOCICLETA





2.4 INSTRUMENTACIÓN

2.4.a Luces indicadoras y de advertencia

- 1) Luz de advertencia de la señal de giro a la izquierda.
- 2) Luz de advertencia de la señal de giro a la derecha.
- 3) Luz de advertencia de presión de aceite del motor insuficiente.
- 4) Luz de advertencia de luz de carretera.
- 5) Luz de advertencia de alta temperatura del refrigerante.
- 6) Testigo de reserva de combustible.
- 7) Testigo ABS.
- 8) Testigo de avería del motor.

Luz de advertencia de la señal de giro a la izquierda “←”

La luz parpadea cuando se inserta el indicador de dirección izquierdo usando la palanca de control especial ubicada en el bloque de control izquierdo.

Testigo de señal de giro a la derecha “→”.

La luz parpadea cuando se inserta el indicador de dirección derecho utilizando la palanca de control especial ubicada en el bloque de control izquierdo.

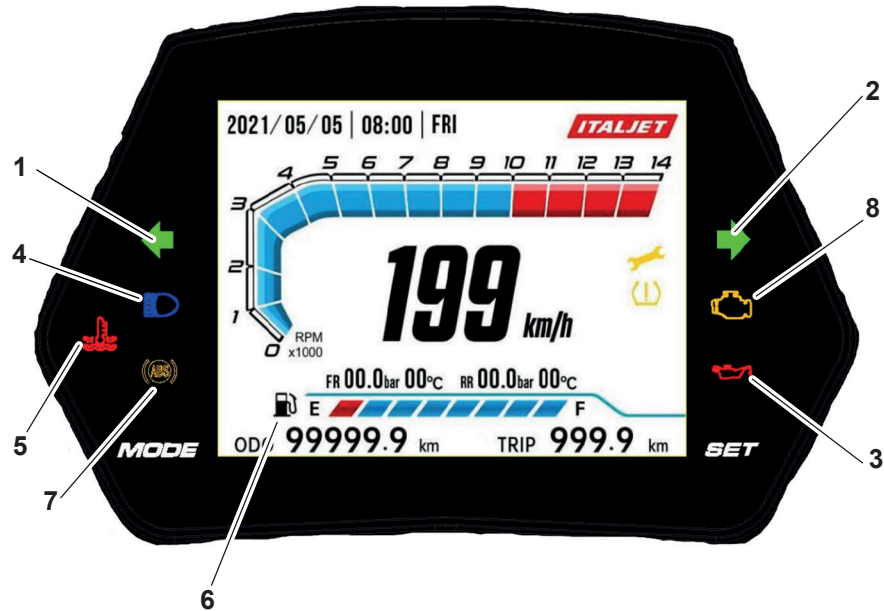

Testigo de presión de aceite del motor insuficiente “”.

Se enciende con la llave de encendido en la posición "ON" y debe apagarse cuando el motor está en marcha. Si permanece encendido o se

enciende con el motor en marcha, detenga el motor y verifique el nivel de aceite como se describe en el párrafo correspondiente o comuníquese con su distribuidor para que revise la falla.





ATENCIÓN

No utilice la motocicleta con una presión de aceite insuficiente; posible falla del motor.

Luz de advertencia de luz de carretera “”.

La luz se enciende cuando se enciende la luz de carretera utilizando el control apropiado ubicado en el bloque de control izquierdo.

Testigo de alta temperatura del refrigerante “”.

Se enciende cuando la temperatura del refrigerante ha alcanzado el valor máximo permitido.

ATENCIÓN

Detenga la motocicleta y apague el motor. No utilice la motocicleta con una temperatura alta del refrigerante; posible falla del motor.

- Espere a que se enfríe el refrigerante y luego verifique el nivel como se describe en el párrafo correspondiente o comuníquese con su distribuidor de confianza para verificar la falla.

Luz de advertencia de combustible bajo “”

Si el testigo se enciende mientras se utiliza la motocicleta, indica que el nivel de combustible ha alcanzado el nivel de reserva (2 litros), lo que indica un recorrido limitado; repostar lo antes posible.

Testigo ABS “”

Al girar la llave, la centralita ABS realiza un autodiagnóstico, el testigo se enciende unos segundos y luego se apaga indicando que no hay anomalías.

Si, por el contrario, el testigo se enciende mientras la motocicleta está en marcha, indica que hay una avería en el sistema de frenado ABS:

- Pare y apague el motor;

- Espere unos minutos y vuelva a arrancar el motor. Si la luz de advertencia se enciende nuevamente, comuníquese con el distribuidor **Italjet** más cercano para que revisen el sistema ABS.

Testigo de avería del motor “”

Al girar la llave de contacto, la unidad de control del motor realiza un autodiagnóstico, el testigo se enciende durante unos segundos y luego se apaga indicando que no hay anomalías.

Si el testigo se enciende con el motor en marcha, indica que hay una avería en el motor o en el sistema de inyección;

- Pare y apague el motor ;
- Espere unos minutos y vuelva a arrancar el motor. Si se enciende la luz de advertencia, póngase en contacto con el distribuidor **Italjet** más cercano para realizar una comprobación del sistema de autodiagnóstico.



2.4.b Instrumento digital

- 1) Indicador de velocidad (velocímetro) km / h - mi / h.
- 2) Fecha / hora / día.
- 3) Indicador de combustible.
- 4) Indicador de km/mi totales recorridos.
- 5) Indicador de km/mi parciales recorridos.
- 6) Luz de advertencia de vencimiento del mantenimiento programado.
- 7) Botón "MODE".
- 8) Botón "SET".

Indicador de velocidad (1)

Indica la velocidad de la motocicleta; la velocidad se puede indicar en km / h o mi / h dependiendo de cómo se haya configurado la unidad de medida.

Fecha/Hora/Día de la semana (2)

- 2a) Indica la fecha; se puede mostrar en el formato "año/mes/día" o bien "día/mes/año"
- 2b) Indica la hora; se puede configurar en formato de 24 horas o bien de 12 horas.
- 2c) Indica el día de la semana.

Indicador de combustible (3)

Indica el nivel de combustible dentro del tanque; la escala completamente visible (3a) indica el nivel máximo, la escala no visible (3a)

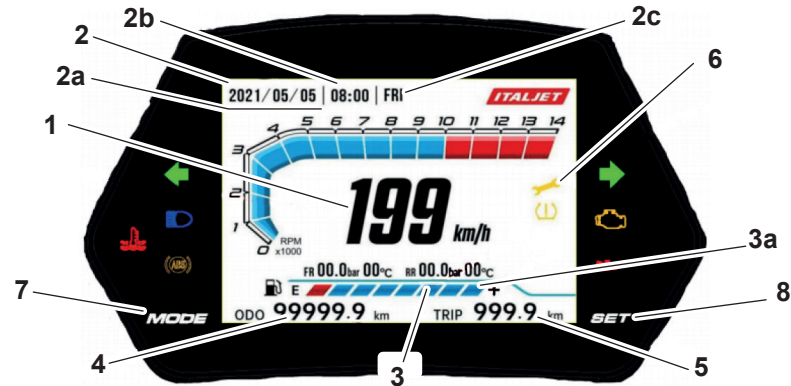

indica el nivel mínimo, la luz "🔔" se enciende.

Indicador de km/mi totales recorridos (4)

En esta parte de la pantalla, se muestran los km/mi totales recorridos.

Indicador de km/mi parciales recorridos (TRIP) (5)

En esta parte de la pantalla, se muestran los km/mi parciales recorridos desde la última puesta a cero.

Indicador de mantenimiento programado vencido (6)

La luz de advertencia parpadea cuando el mantenimiento está a 100km / 62mi.

La luz de advertencia permanece fija cuando se exceden los km / mi del intervalo de mantenimiento y permanece fija hasta que se reinicia.

Después de realizar el mantenimiento, visualice TOTAL ODO, luego presione el botón de "mode" (7) durante más de 10 segundos; el indicador de mantenimiento se apaga.

Botón MODE (7)

El botón "mode" le permite desplazarse por el software.

Botón SET (8)

El botón "set" le permite configurar la unidad de medida y borrar los contadores parciales.



2.5 AJUSTE Y CONFIGURACIÓN DE PANTALLA

⚠ PELIGRO

Todos los ajustes deben realizarse con la motocicleta detenida.



Ajuste de km / mi y reloj de 24 horas / 12 horas

- Presione el botón **"mode"** hasta que se muestre el total de km / mi.
- Mantenga pulsado el botón **"set"** durante al menos diez segundos para cambiar de la unidad de medida km + reloj de 24 horas a mi (millas) + reloj de 12 horas y viceversa; los contadores parciales se ponen a cero.

Configuración de hora

- Pulse los botones de **"mode"** y **"set"** al mismo tiempo durante más de dos segundos, las horas y los minutos comienzan a parpadear.
- Presione la tecla **"mode"** para aumentar las horas y la tecla **"set"** para aumentar los minutos.
- Pulse los botones **"mode"** y **"set"** simultáneamente durante más de dos segundos para confirmar el ajuste de la hora.

Configuración de km / mi y horas parciales "Viaje A o Viaje B"



- Presione el botón **"mode"** hasta que se muestre "Viaje A" o "Viaje B", presionando rápidamente el botón **"set"** puede cambiar entre la visualización de los km / mi parciales recorridos a las horas parciales del viaje.
- Para poner a cero los km / mi parciales recorridos y el tiempo parcial, presione el botón **"set"** durante más de dos segundos, los valores se resetean y comienza una nueva cuenta.



2.6 COMANDOS

2.6.a Bloqueo de teclas

El bloque de teclas tiene tres posiciones:



-  posición de arranque de la motocicleta (llave no extraíble);
-  posición de extracción de la llave;

Posición de bloqueo de dirección “**lock**” (llave extraíble).

- Posición de extracción de llave “”

Al girar la llave a la posición “”, el motor y las luces se apagan y es posible sacar la llave de la cerradura.

- Posición inicial “”

Desde la posición “” (extracción de la llave) girar la llave (1) en el sentido de las agujas del reloj hasta la posición “”; las luces, la pantalla se iluminará y se podrá arrancar la motocicleta.





2.6.b "Lock" bloqueo de la dirección

Para bloquear la dirección, opere de la siguiente manera:

- Girar el manillar completamente a la izquierda
- Insertar la llave (1) en el bloque (2) en posición .
- Pulsar la tecla (1) y girarla en sentido antihorario hasta la posición de "lock".
- Retirar la llave (2).





Para desbloquear la dirección, opere en reversa.





2.7 BLOQUE DE CONTROL IZQUIERDO

El bloque de la izquierda tiene los siguientes comandos:

-  Deslumbraante destello.
-  Interruptor de luz de cruce / luz de carretera.
-  Interruptor de luz de emergencia.
-  Cuerno.
-  Interruptor de indicador de dirección.



Luz de carretera “”

Presione el botón (1) cuando los faros de cruce estén encendidos.





Interruptor de luz de cruce / luz de carretera “”

Dependiendo de la posición del interruptor (2) se encienden las luces de cruce o de carretera:

-  Luces de cruce iluminadas.
-  Luces de carretera iluminadas.

Interruptor de luz de emergencia “”



Pulsando el conmutador (3) todos los intermitentes parpadean simultáneamente y las luces “” y “” parpadean en el salpicadero.

NOTA: Utilice las luces de emergencia solo cuando sea necesario para advertir a otros vehículos que su motocicleta está parada. El uso de las luces de emergencia con el motor apagado podría agotar las baterías.

Cuerno “”

Presione el botón (4) para activar la bocina.

Interruptor de indicador de dirección “”



Moviendo el interruptor (5) hacia “” inserta el indicador de dirección izquierdo, moviendo el interruptor (5) hacia “” inserta el indicador de dirección derecho: Una vez liberado, el interruptor vuelve a la posición central. Para apagar el indicador de dirección insertado, presione el interruptor una vez que esté en la posición central.





2.8 BLOQUE DE CONTROL DERECHO

El bloque de la derecha tiene los siguientes comandos:

1.  Interruptor de emergencia parada del motor.
2.  Botón de arranque del motor.



2.8.a Interruptor de EMERGENCIA de parada del motor



ATENCIÓN

Presione el interruptor (1) para apagar el motor solo en caso de una Emergencia real.

Cuando se presiona en la posición “”, inhabilita el arranque y el funcionamiento del motor.

Cuando se presiona en la posición “” permite que el motor funcione y arranque.

2.8.b Botón de arranque del motor

Al presionar el botón (2) con la llave en la posición “” y el interruptor (1) en la posición “”, presione una palanca de freno y el motor arranca.

2.9 CONTROL DEL ACELERADOR

El puño del acelerador (1) se encuentra en el lado derecho del manillar.





2.10 CONTROL DE FRENO DELANTERO

La palanca de freno (1) se encuentra en el lado derecho del manillar. Un interruptor de parada, al frenar, hace que se encienda la luz trasera. Para aplicar el freno, tire de la palanca hacia el puño del acelerador.

La posición del mando en el manillar se puede ajustar aflojando los dos tornillos de fijación (2).

ADVERTENCIA

No olvide apretar los tornillos (2) después del ajuste.

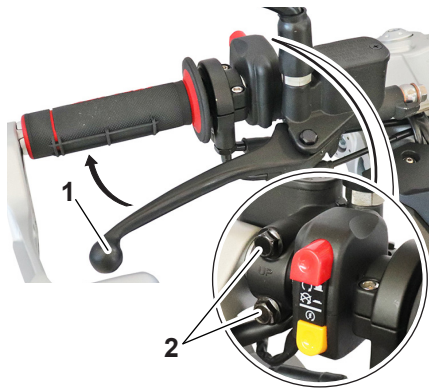

2.11 CONTROL DE FRENO TRASERO

La palanca de freno (1) se encuentra en el lado izquierdo del manillar. Un interruptor de parada, al frenar, hace que se encienda la luz trasera.

Para activar el freno, tire de la palanca hacia la perilla.

La posición del mando en el manillar se puede ajustar aflojando los dos tornillos de fijación (2).

ADVERTENCIA

No olvide apretar los tornillos (2) después del ajuste.





2.12 TANQUE DE GASOLINA

! PELIGRO

La gasolina es extremadamente inflamable y puede volverse explosiva bajo ciertas condiciones. Siempre apague el motor, no fume ni se acerque a llamas o chispas en el área donde reposta o almacena combustible.

2.12.a Repostaje

- Apague el motor.
- Levantar la tapa de la cerradura (1).
- Insertar la llave (2) y girarla 1/4 de vuelta en el sentido de la flecha "A" para quitar el tapón (3).
- Vierta el combustible en el tanque.

! ADVERTENCIA

No llene el tanque más allá del límite inferior de la boca de llenado, si el combustible se desborda, limpie el combustible inmediatamente con un trapo ya que, además de ser extremadamente inflamable, puede deteriorar las superficies pintadas o plásticas.

- Vuelva a colocar el tapón (3) procediendo inversamente a las operaciones de desmontaje, girando la llave en el sentido de la flecha "B", luego retire la llave (2) y baje la tapa de protección de la cerradura (1).

NOTA: No es posible volver a colocar el tapón de combustible (3) sin la llave insertada en la cerradura; es posible quitar la llave (2) del tapón (3) solo si este último está correctamente cerrado.

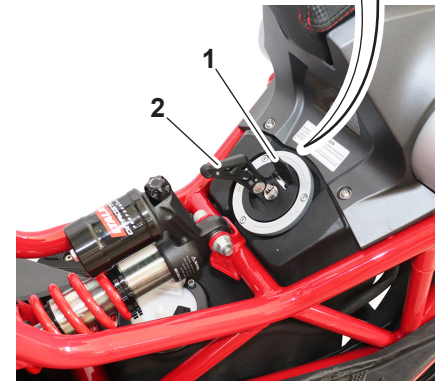
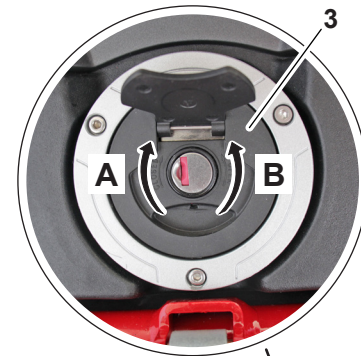



⚠ ADVERTENCIA

Compruebe que la tapa del tanque esté bien cerrada después de repostar. Las fugas de combustible constituyen un riesgo de incendio.

2.13 COMBUSTIBLE

⚠ ADVERTENCIA

La gasolina es venenosa y puede causar lesiones o la muerte. Manipule la gasolina con cuidado. Nunca aspire gasolina con la boca. Si se ingiere gasolina o si se inhalan grandes cantidades de vapores de gasolina, o si la gasolina entra en contacto con los ojos, busque atención médica inmediata.

Si se derrama gasolina en la piel, lávese con agua y jabón. Si derrama gasolina en su ropa, cámbiela

El motor fue diseñado para usar gasolina sin plomo con un octanaje controlado de 95 o más. Si el motor golpea, use una marca diferente o gasolina de mayor octanaje.

Combustible recomendado:

Gasolina sin plomo
(E10 admisible)

Número de Octano (RON):
95

E5

E10

NOTA:

- Esta referencia identifica el combustible recomendado para este vehículo según lo especificado por la normativa europea (EN228).
- Compruebe que la boquilla de la bomba de combustible tenga la misma referencia de identificación de combustible.

2.13.a Diferentes tipos de gasolina

Hay varios tipos de gasolina que contienen etanol. Se puede utilizar gasolina que contenga etanol si el contenido de etanol no supera el 10% (E10). **Italjet** no recomienda gasolina que contenga metanol, ya que puede causar daños al sistema de combustible o problemas de rendimiento del vehículo.

ATENCIÓN

Utilice únicamente gasolina sin plomo. El uso de gasolina con plomo provocaría graves daños tanto en las partes internas del motor, como válvulas y segmentos, como en el sistema de escape.



2.13.b Convertidor catalítico

El sistema de escape incluye convertidores catalíticos para reducir las emisiones de escape nocivas.

⚠ ADVERTENCIA

El sistema de escape alcanza altas temperaturas después de hacer funcionar la motocicleta. Para prevenir el riesgo de incendio o quemaduras:

- No estacione el vehículo cerca de materiales que puedan representar un peligro de incendio, como césped u otros materiales fácilmente combustibles.
- Estacione el vehículo en un lugar donde no haya peligro de que los peatones o los niños toquen el sistema de escape caliente.

- Compruebe que el sistema de escape se haya enfriado antes de realizar trabajos de mantenimiento en él.
- No haga funcionar el motor al ralentí ni siquiera durante unos minutos. Un ralentí prolongado que puede provocar la acumulación de calor.

2.14 ACCESORIOS Y TOMA USB

ATENCIÓN

El accesorio conectado a la toma USB no debe usarse con el motor apagado y la carga nunca debe exceder los 12W (1A), de lo contrario el fusible podría quemarse y la batería descargada.

2.14.a Per utilizzare la toma USB

- Levantar la protección (1).
- Conectar el accesorio a la toma (2).
- Cuando no se utilice el enchufe, reposicione la protección correctamente.

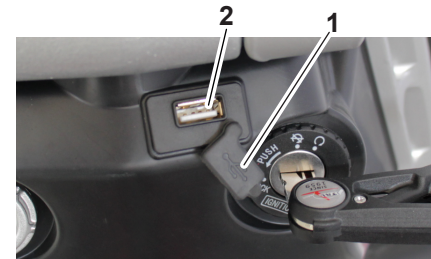



2.14.b Compartimento de almacenamiento debajo del sillín

- Coloque la motocicleta en el caballete lateral o en el caballete central.
- Introduzca la llave (1) en la cerradura (2) y gírela hasta que se suelte la cerradura del asiento.

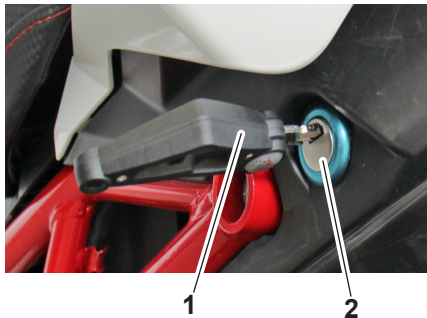

- Levantar el sillín (3) para acceder al compartimento (4).
- Para cerrar el sillín, bájelo y empujelo hacia abajo para que se enganche en la cerradura.

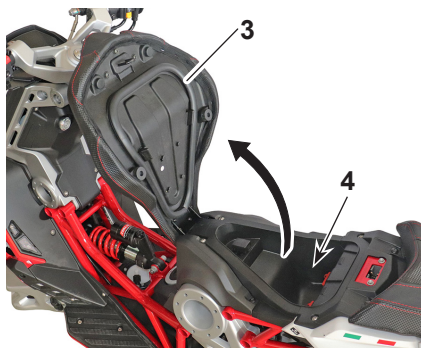

NOTA: Después de abrir el compartimento debajo del sillín, es posible sacar la llave de la cerradura.





2.14.c Caballete lateral

ATENCIÓN

El pie de apoyo está diseñado para soportar **SOLAMENTE EL PESO DE LA MOTOCICLETA**.

No se siente en el vehículo usando el soporte como soporte; Podría producirse una rotura que provoque lesiones personales graves.

ATENCIÓN

La motocicleta **DEBE** colocarse en el caballete lateral **SÓLO DESPUÉS** de que el conductor haya abandonado el vehículo.

ATENCIÓN

Se coloca un sensor de seguridad en la motocicleta que no permite arrancar la motocicleta, con el soporte bajado. Cuando se baja el caballete con la motocicleta en marcha, el motor se detiene.

El caballete lateral se encuentra en el lado izquierdo del marco. Suba o baje el pie de apoyo (1) con el pie mientras sostiene el vehículo en posición vertical.

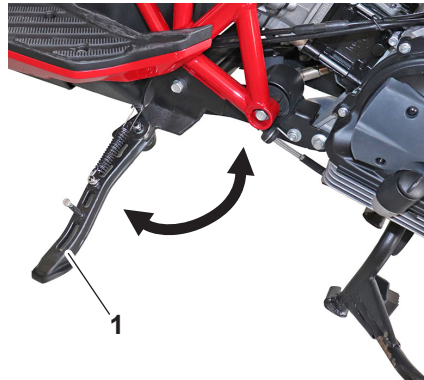

⚠ PELIGRO

No utilice la motocicleta con el caballete lateral bajado. Si el caballete lateral no permanece elevado, es necesario ponerse en contacto con el distribuidor *Italjet* más cercano para su reparación. Controlar periódicamente el correcto funcionamiento del caballete lateral y el correcto funcionamiento del sensor de seguridad que bloquea el arranque de la motocicleta con el caballete bajado.



2.14.d Caballete central

- Agarre el puño izquierdo del manillar (1) y el asa del pasajero izquierdo (2).
- Presionar la palanca (3) del caballete central (4) con el pie derecho y al mismo tiempo levantar la motocicleta hacia arriba y hacia atrás hasta que esté completamente levantada sobre el caballete central.

ATENCIÓN

Cuando el vehículo está estacionado en el caballete central, es peligroso sentarse a bordo, colocando el peso sobre el soporte de estacionamiento.

Para bajar la motocicleta del caballete central, proceda como se describe a continuación.

- Agarre la manija izquierda (1) y la manija izquierda (2) del pasajero.
- Coloque el pie delante del caballete y empuje la motocicleta hacia adelante hasta que se salga del caballete; el soporte se levantará automáticamente.





3.1 COMPROBACIONES ANTES DEL USO

Inspeccione el vehículo cada vez que lo use para asegurarse de que esté en condiciones seguras para operar. Observe siempre los procedimientos e intervalos de inspección y mantenimiento descritos en el manual de uso y mantenimiento.

ADVERTENCIA

No realizar una inspección o mantenimiento adecuados del vehículo aumenta la posibilidad de accidentes o daños al vehículo. No utilice el vehículo si tiene problemas. Si el mal funcionamiento no se puede eliminar con las instrucciones proporcionadas en este manual, haga que un concesionario *Italjet* inspeccione el vehículo.

Antes de utilizar este vehículo, compruebe los siguientes puntos:

ELEMENTO	COMPROBACIONES
Combustible	<ul style="list-style-type: none"> - Verifique el nivel de combustible en el tanque de combustible. - Repostar si es necesario. - Compruebe si hay fugas en el circuito de combustible.
Aceite de motor	<ul style="list-style-type: none"> - Controlar el nivel de aceite en el motor. - Si es necesario, agregue aceite del tipo recomendado hasta el nivel. - Compruebe la ausencia de fugas de aceite del motor.
Aceite de transmisión final	<ul style="list-style-type: none"> - Compruebe la ausencia de fugas de aceite de la transmisión.
Refrigerante	<ul style="list-style-type: none"> - Controlar el nivel de refrigerante en el depósito de expansión. - Si es necesario, añada líquido refrigerante. - Compruebe que no haya fugas en el sistema de refrigeración.
Ruedas y neumáticos	<ul style="list-style-type: none"> - Compruebe si hay daños. - Verificar el estado de los neumáticos y la profundidad de la banda de rodadura. - Verifique la presión del aire.



ELEMENTO	COMPROBACIONES
Frenos	<ul style="list-style-type: none">- Verificar el funcionamiento de los frenos.- Si tiene una sensación de suavidad y flexibilidad, haga que un distribuidor Italjet revise el sistema de seguridad.- Controlar el desgaste de las pastillas de freno.- Reemplácelos si es necesario (para reemplazarlos, comuníquese con un distribuidor Italjet).- Controlar el nivel de líquido en el depósito, rellenar si es necesario (para rellenar, contactar con un distribuidor Italjet)- Controlar que no haya fugas en el sistema hidráulico.
Caballote lateral, caballote central	<ul style="list-style-type: none">- Asegúrese de que el movimiento sea suave.- Lubricar los puntos de pivote si es necesario.
Instrumentos, luces, señales e interruptores	<ul style="list-style-type: none">- Verificar el funcionamiento de las luces y los intermitentes.
Interruptor de caballote lateral	<ul style="list-style-type: none">- Verificar el funcionamiento del sistema de interrupción del circuito de encendido.- Si el sistema no funciona correctamente, haga que un concesionario Italjet revise el vehículo.



3.2 INSTRUCCIONES PARA EL USO DE LA MOTOCICLETA

NOTA: Si no está familiarizado con el funcionamiento de la motocicleta, antes de conducirla, lea atentamente las instrucciones contenidas en el párrafo "CONTROLES".

3.2.a Instrucciones de rodaje

Durante los primeros 1000 km se deben observar escrupulosamente las siguientes reglas, cuyo INCUMPLIMIENTO PUEDE JUZGAR LA VIDA Y EL RENDIMIENTO DE LA MOTOCICLETA:

- Antes de utilizar el vehículo, caliente el motor a un número reducido de revoluciones;
- Evite los arranques rápidos y no haga funcionar el motor a altas revoluciones;
- Conduzca a velocidad moderada hasta que el motor se caliente;
- Utilice repetidamente ambos frenos para hacer funcionar las pastillas y los discos;
- Evite mantener la misma velocidad durante mucho tiempo;
- Evite viajar largas distancias sin hacer paradas.

3.2.b Identificación de problemas operativos

La siguiente lista de problemas operativos sirve, en general, para identificar su origen e implementar la solución.

El motor no arranca

- Técnica de arranque inadecuada: siga las instrucciones del párrafo "Arranque del motor";
- Caballete lateral bajado.

El motor tarda en arrancar

- Bujía sucia o en mal estado: sustituir

El motor arranca pero el funcionamiento es errático

- Bujía sucia o en mal estado: sustituir;

La bujía se ensucia fácilmente

- Bujía inadecuada, reemplace

El motor carece de potencia

- Filtro de aire sucio: limpio;

Los frenos no funcionan correctamente

- Pastillas gastadas: reemplácelas en un taller de reparación especializado.

ATENCIÓN

Para todos los demás problemas, póngase en contacto con un distribuidor de *Italjet*.



3.3 ASCENSO / DESCENSO DEL CONDUCTOR Y PASAJERO

3.3.a Reglas generales

Lea atentamente las siguientes instrucciones, ya que proporcionan información importante para la seguridad del conductor y el pasajero para evitar lesiones a personas o daños a la motocicleta.

La subida y bajada de la motocicleta debe realizarse siempre por el lado izquierdo de la motocicleta, con las manos libres, sin obstáculos y con el caballete central elevado.

Si el caballete lateral está presente, el ciclista puede subir con el caballete hacia abajo.

El conductor debe ser el primero en subir y el último en bajarse de la motocicleta y debe controlar la estabilidad de la motocicleta durante el ascenso y descenso del pasajero.

No salga del vehículo saltando o extendiendo la pierna, salga siempre realizando las operaciones descritas en el párrafo correspondiente.

3.3.b Ascenso del conductor

Levante el caballete central. Si hay un caballete lateral, déjelo en la posición baja.

- Desde el lado izquierdo, sujete correctamente el manillar con ambas manos, luego levante la pierna derecha y pase el sillín.
- Siéntese en la motocicleta y coloque ambos pies en el suelo, enderezando el vehículo sin cargar su peso en el caballete lateral (si está presente).

ADVERTENCIA

Si no puede colocar ambos pies en el suelo, coloque el pie derecho con el pie izquierdo listo para apoyarse.

- Con el pie izquierdo, retraiga completamente el caballete lateral (si lo hubiera);
- Arranque la motocicleta como se describe en el párrafo correspondiente.

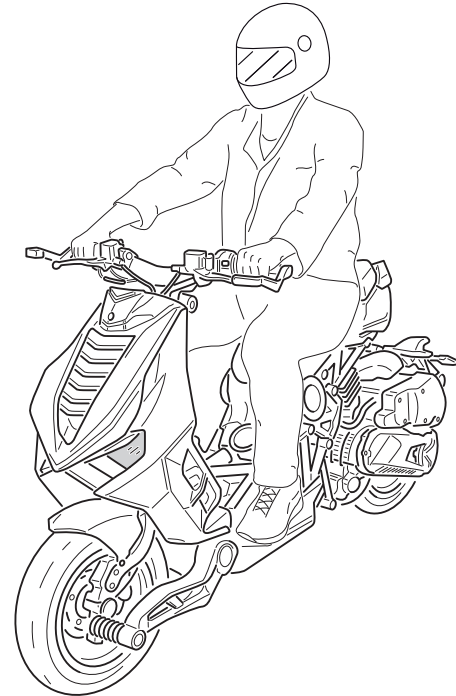



3.3.c Ascenso del pasajero

- El conductor debe subirse a la motocicleta como se describe en el párrafo correspondiente, sin arrancar la motocicleta.
- El pasajero debe extraer los reposapiés (1).

⚠ ADVERTENCIA

El conductor en el puesto de conducción no debe extraer ni intentar extraer los reposapiés del pasajero trasero, ya que esto podría comprometer el equilibrio del vehículo.

- Sube a la bicicleta levantando la pierna derecha, moviéndote con cuidado para no desequilibrar el vehículo y el ciclista.

- Con las manos agarre las asas (2).
- Con el pie izquierdo, retraiga completamente el caballete lateral (si está presente).
- Arranque la motocicleta como se describe en el párrafo correspondiente.

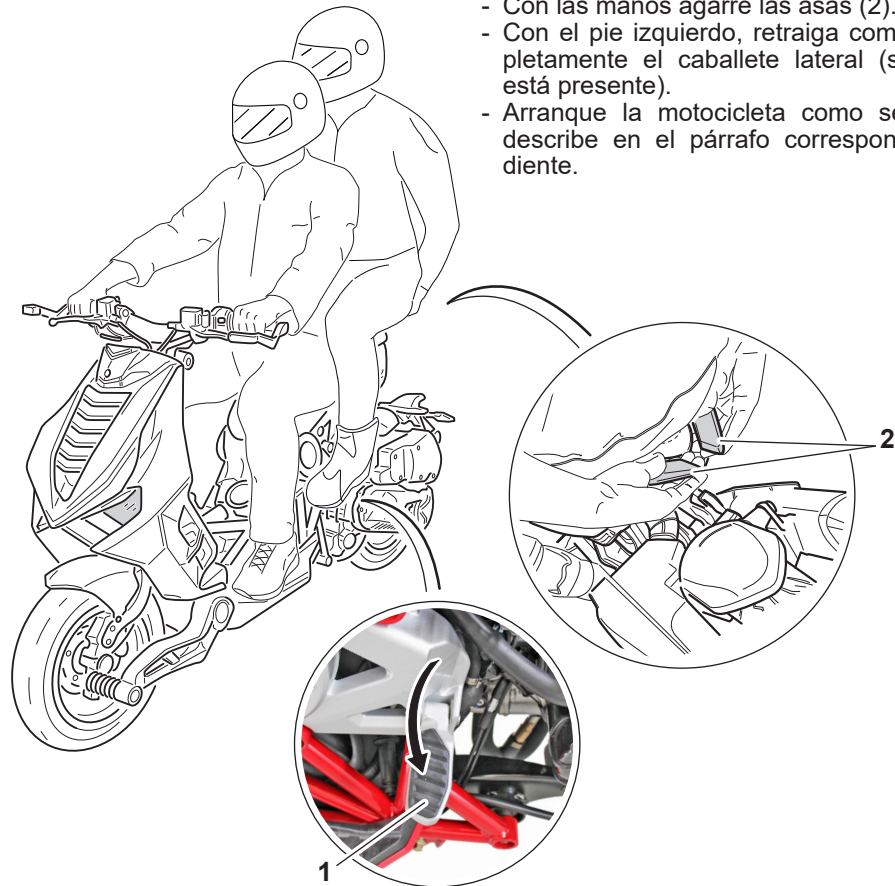



3.3.d Descenso de la motocicleta

- Detenga el vehículo y apague el motor.

⚠ ADVERTENCIA

Asegúrese de que el área donde se estacionará el vehículo sea estable y nivelada.

- Coloque ambos pies en el suelo.
- Apague la motocicleta como se describe en el párrafo correspondiente.
- Con el pie izquierdo, extraiga completamente el caballete lateral (si está presente).
- El pasajero debe bajarse primero del lado izquierdo del vehículo levantando su pierna derecha.
- Incline la motocicleta hacia la izquierda hasta que descansa sobre el caballete lateral, si lo hubiera.
- Con las manos firmemente en el manillar, bájese de la bicicleta por el lado izquierdo levantando la pierna derecha.

3.4 AJUSTE DE LOS ESPEJOS RETROVISORES

Siéntese en la motocicleta como se describe en el párrafo relativo.

Ajuste ambos espejos (1) moviéndolos directamente de modo que desde una posición sentada el conductor pueda ver correctamente la parte trasera de la carretera.









4.1 ARRANQUE DE LA MOTOCICLETA

Después de subir a la motocicleta, como se indica en el párrafo correspondiente, para arrancar el motor proceda de la siguiente manera:

NOTA: La motocicleta no arrancará si el caballete lateral está bajado.

- Poner la llave (1) del interruptor de encendido en la posición “”.



- El testigo “”, se enciende durante unos segundos y luego se apaga mientras las luces “”, “” permanecen encendidas hasta que se pone en marcha la motocicleta.

- Asegúrese de que el puño del acelerador (2) esté completamente liberado y que el caballete lateral esté en posición de funcionamiento.
- Tirar de una de las dos palancas de freno.
- Presione el botón de arranque del motor (3) y suéltelo en cuanto arranque el motor.



NOTA: La luz de advertencia “ABS” permanece encendida hasta que el vehículo alcanza una velocidad de 10 km / h (6 mi / h) y luego se apaga.

NOTA: No haga funcionar el motor frío a un número elevado de revoluciones para permitir que el aceite se caliente y circule en todos los puntos que necesitan lubricación.





4.1.a Uso del acelerador

- Soltar la palanca de freno tirada y girar simultáneamente el puño del acelerador (1); La velocidad es directamente proporcional a la rotación del puño del acelerador, girando el pomo hacia "A" la motocicleta acelera, girando el pomo hacia "D" la motocicleta desacelera.

4.1.b Uso de los frenos

Para tener una acción de frenado más incisiva, es recomendable aplicar ambos frenos al mismo tiempo.

- Soltar el puño del acelerador (1) y tirar de ambas palancas de freno (2) aumentando gradualmente la presión según el grado de frenado deseado.

ADVERTENCIA

Evite frenadas bruscas, tenga mucho cuidado al frenar con la motocicleta en una pendiente, peligro de caída. En algunas condiciones, el uso independiente del freno delantero o trasero puede resultar útil. Utilice el freno delantero con cuidado, especialmente en terrenos resbaladizos. El uso incorrecto de los frenos puede provocar accidentes graves.







4.1.c Parada de la motocicleta y el motor

- Suelte completamente el puño del acelerador (1) para desacelerar la motocicleta.
- Freno tanto delantero como trasero.
- Una vez parada la motocicleta, girar la llave de contacto (2) a la posición “” (posición de extracción de la llave), el motor se para.



4.1.d Parada del motor en caso de emergencia

- Para detener el motor en caso de emergencia, presione el interruptor rojo (1) en “”; después de detener la motocicleta, vuelva a colocar el interruptor (1) en la posición “”.

ADVERTENCIA

En el caso de que el acelerador se bloquee en la posición abierta u otro mal funcionamiento que provoque que el motor gire incontrolablemente, presione **INMEDIATAMENTE** el botón de parada del motor (1). Mantenga el control de la motocicleta con el uso normal de los frenos y la dirección mientras presiona el botón de parada.



4.1.e Estacionamiento de la motocicleta

Coloque la motocicleta en el caballete lateral o en el caballete central como se describe en los párrafos correspondientes.

ADVERTENCIA

- Después de apagar la motocicleta, el motor y el sistema de escape pueden calentarse mucho, intente estacionarse para que los peatones no toquen accidentalmente estas partes.
- No estacione cerca de pasto seco u otros materiales inflamables que puedan incendiarse.
- No estacione en pendientes o en terreno blando; la motocicleta podría volcar con una posible fuga de combustible y peligro de incendio.



5.1 MANTENIMIENTO Y CONTROLES PERIÓDICOS

5.1.a Mantenimiento periódico

Las inspecciones, los ajustes y las lubricaciones periódicas mantienen la motocicleta en las mejores condiciones posibles de seguridad y eficiencia. Los puntos más importantes relacionados con las comprobaciones, los ajustes y la lubricación de la motocicleta se ilustran en las páginas siguientes.

Los intervalos de mantenimiento que se muestran en la tabla solo deben considerarse como una guía general en condiciones normales de conducción. Sin embargo, puede ser necesario reducir los intervalos de mantenimiento según las condiciones climáticas, el terreno, la posición geográfica y el uso individual.

ADVERTENCIA

La falta de mantenimiento o un mantenimiento incorrecto de la motocicleta puede aumentar el riesgo de lesiones o muerte durante el uso del vehículo. Haga que el mantenimiento lo lleve a cabo un distribuidor *Italjet* o un reparador profesional.

ADVERTENCIA

Antes de realizar cualquier operación de mantenimiento, compruebe que dispone de las herramientas, componentes y habilidades técnicas necesarias.

- Apague el motor y estacione la motocicleta sobre una superficie plana y sólida.
- Espere a que se enfríen el motor, el silenciador y los discos de freno.

ADVERTENCIA

Si utiliza el vehículo en carreteras polvorrientas, embarradas o muy mojadas, es necesario limpiar / reemplazar el filtro de aire con un intervalo de mantenimiento más corto. Acuda a su distribuidor *Italjet* para conocer el intervalo de mantenimiento correcto.



Intervalo de mantenimiento	<i>Tiempo o kilometraje</i>											
	Tiempo (meses)	6	12	18	24	30	36	42	48	54	60	66
Voces	Kilometraje (km x 1000)	1	6	12	18	24	30	36	42	48	54	60
Motor												
Rodillo de polea guiada				L		L		L		L		L
Casquillo de plástico de la tapa del variador				R		R		R		R		R
Campana de embrague			C	C	C	C	C	C	C	C	C	C
Correa de transmisión				R		R		R		R		R
Filtro de aire de transmisión				I		I		I		I		I
Prefiltro de malla de aceite del motor	C	C	C	C	C	C	C	C	C	C	C	C
Filtro de aceite de motor	R	R	R	R	R	R	R	R	R	R	R	R
Holgura de la válvula				A		A		A		A		A
Aceite de transmisión	R		R		R		R		R		R	
Aceite de motor (*)	R	R	R	R	R	R	R	R	R	R	R	R
Rodillos CVT				R		R		R		R		R
Variador de media polea frontal móvil				I		I		I		I		I
Transmisión				L		L		L		L		L
Bujía				R		R		R		R		R
Filtro de aire			C	C	C	C	C	C	C	C	C	C



Intervalo de mantenimiento	<i>Tiempo o kilometraje</i>											
	Tiempo (meses)	6	12	18	24	30	36	42	48	54	60	66
	Kilometraje (km x 1000)	1	6	12	18	24	30	36	42	48	54	60
Voces												
Sistema de vaporización												
Contenedor y tubos	I		I		I		I		I		I	
Sistema de refrigeración												
Nivel de refrigerante (**)	I	I	I	I	I	I	I	I	I	I	I	I
Radiador			C		C		C		C		C	
Planta de energía												
Filtro de combustible			R		R		R		R		R	
Tuberías de combustible (***)	I		I		I		I		I		I	
Sistema eléctrico												
Voltaje de la batería	I		I		I		I		I		I	
Ajuste de faros			A		A		A		A		A	
Prueba de carretera del vehículo												
Prueba de carretera del vehículo	I		I		I		I		I		I	



Intervalo de mantenimiento	<i>Tiempo o kilometraje</i>											
	Tiempo (meses)	6	12	18	24	30	36	42	48	54	60	66
Voces	Kilometraje (km x 1000)	1	6	12	18	24	30	36	42	48	54	60
Chasis												
Fijaciones de seguridad		I		I		I		I		I		I
Frenos		I	I	I	I	I	I	I	I	I	I	I
Líquido de los frenos (**)		I		I		I		I		I		I
Suspensiones				I		I		I		I		I
Ruedas / neumáticos		I	I	I	I	I	I	I	I	I	I	I
Dirección		I		I		I		I		I		I
Sistema de escape				I		I		I		I		I
Control del acelerador		A		A		A		A		A		A

I: Revise y limpie, ajuste, engrase o reemplace si es necesario

C: Limpio

R: Reemplazar

A: Ajustar

L: Lubricar

(*) Verificar el nivel cada 3000 km

(**) Reemplazar cada 2 años

(***) Reemplazar cada 4 años



5.1.b Comprobación del nivel de aceite

NOTA: El control debe realizarse con el motor recién apagado y aún caliente.

ADVERTENCIA

El silenciador de la motocicleta alcanza altas temperaturas, tenga cuidado de no quemarse.

- Colocar la motocicleta sobre una superficie nivelada, en posición vertical elevada sobre el caballete central.
- Espere unos minutos para que se asiente el aceite.
- Desenroscar la varilla (1) y quitarla, limpiar la varilla con un trapo y volver a introducirla en el orificio de llenado (2) sin atornillarla, luego quitarla y comprobar que el nivel de aceite está entre las marcas de nivel mínimo "MIN "y máximo" MAX ".
- En caso de rellenar, introducir aceite por el orificio (2) hasta el nivel MAX y no más allá.
- Vuelva a montar la varilla (1) atornillándola.

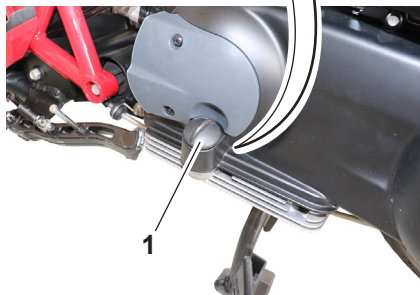
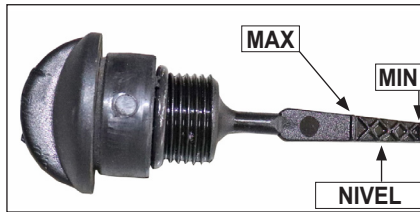

5.1.c Reemplazo del filtro y aceite del motor

NOTA: El cambio de aceite debe realizarse con el motor recién apagado y aún caliente.

ADVERTENCIA

Tenga cuidado de no quemarse con aceite caliente.

- Colocar la motocicleta sobre una superficie nivelada, en posición vertical elevada sobre el caballete central.
- Retirar la varilla del nivel de aceite (1).

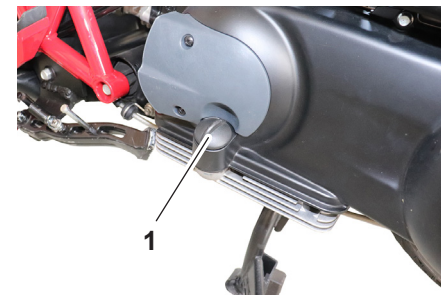



- Colocar una cubeta en correspondencia con el tapón de drenaje (2).
- Desenroscar el tapón de vaciado (2) y dejar drenar todo el aceite.

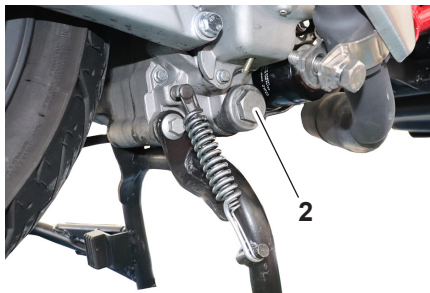

- Mediante la correspondiente herramienta (4), desenroscar el filtro de aceite (5).

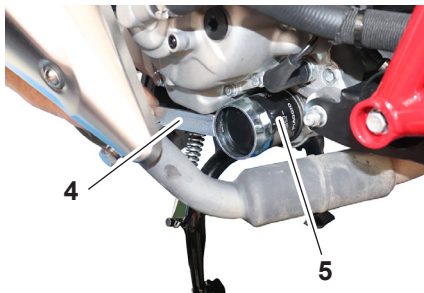

- Limpiar el filtro (3), sustituirlo si está dañado y, luego, montarlo de nuevo.

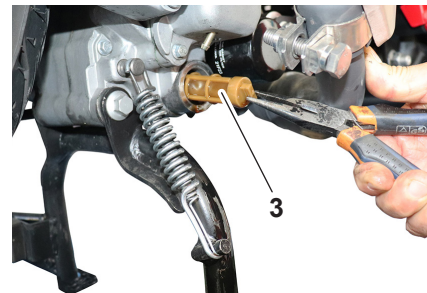

- Mediante una pinza, quitar el filtro (3) lavable.

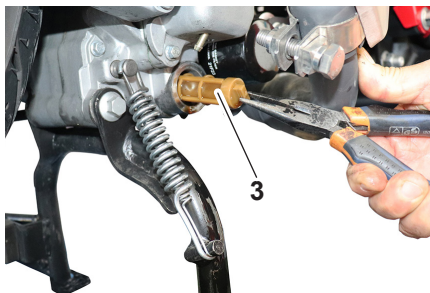

- Quitar el filtro (5).

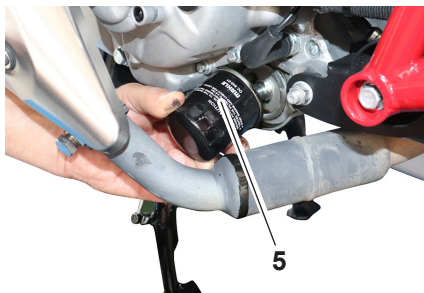

- Comprobar el estado de la junta (6) del tapón (2) y sustituirla si está dañada.

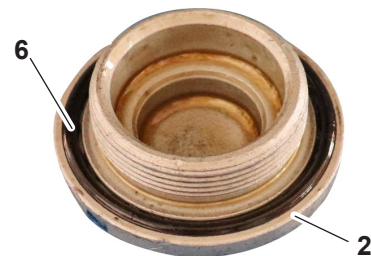



- Montar de nuevo el tapón (2) enroscándolo con par de 25 Nm / 18,44 ft/lb.

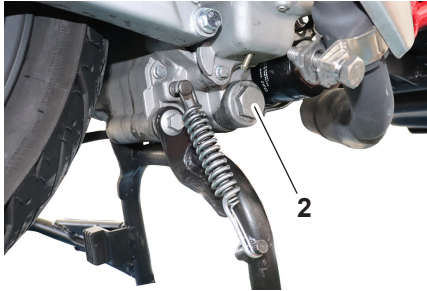

- Montar el filtro (5) enroscándolo con la correspondiente herramienta (4) con un par de apriete de 12 Nm / 8,85 ft/lb.

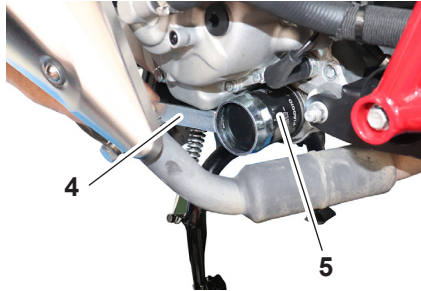

- Vuelva a montar la varilla (1) atornillándola.



NOTA: Para el tipo de aceite que se utilizará, consulte el párrafo "Repostar".

NOTA: Limpie el aceite derramado en las piezas con un trapo después de que el motor y el sistema de escape se hayan enfriado.

- Lubricar la junta (7) con aceite.



- Echar aproximadamente 1250 cm³ de aceite en el correspondiente depósito por el orificio (8).

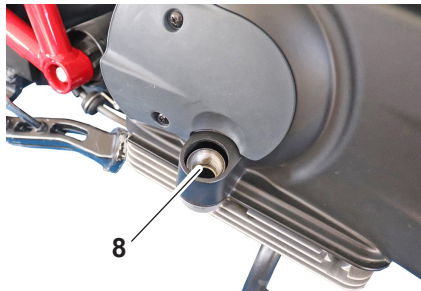

- Arranque el motor y déjelo en ralentí durante varios minutos, comprobando que no haya fugas de aceite. Si hay una fuga de aceite, detenga el motor inmediatamente y busque la causa.
- Apagar el motor, controlar el nivel de aceite y corregirlo si es necesario.
- Restablezca el intervalo de mantenimiento como se describe en el párrafo "Instrumento digital".





5.1.d Comprobación del nivel de refrigerante

NOTA: Verifique el nivel de refrigerante con el motor frío.

- Colocar la motocicleta sobre una superficie nivelada, en posición vertical elevada sobre el caballete central.
- Retirar la tapa (1) del depósito de expansión (2).



- Compruebe que el nivel de líquido se encuentre entre el nivel mínimo "MIN" y el nivel máximo "MAX" del tanque.

- Si es necesario rellenar, quitar el tapón del depósito (3) desenroscándolo e introducir el refrigerante por el orificio (4) comprobando el nivel en el depósito (2).
- Una vez restablecido el nivel, vuelva a colocar el tapón (3) y la tapa (1).

NOTA: El refrigerante es corrosivo, si se derrama un poco durante el llenado, limpiar cuidadosamente las partes que han estado en contacto con el agua.

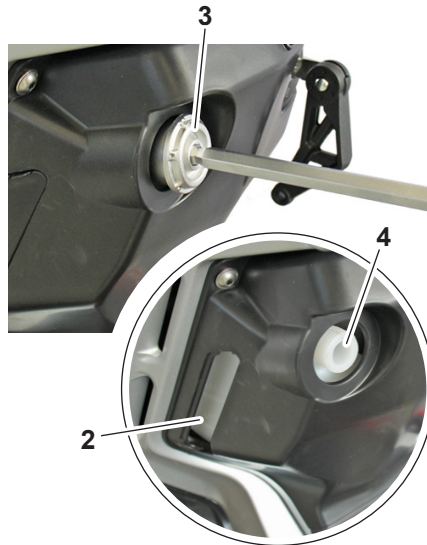

5.1.e Limpieza del filtro de aire del motor

- Destornillar los tornillos (1) y quitar la tapa (2).

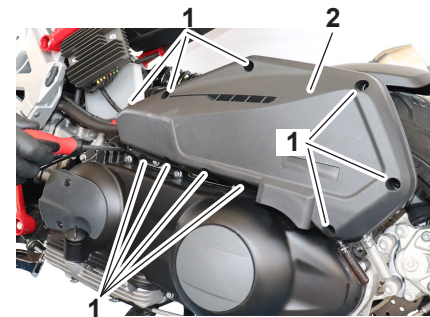

- Retire el filtro (3) de la tapa del filtro (2).

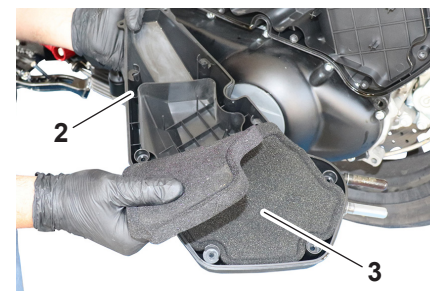



- Limpiar el filtro (3) con un limpiador de filtros adecuado y dejar que se seque por completo.

⚠ ADVERTENCIA

No utilice gasolina u otros disolventes inflamables para limpiar el filtro.

- Compruebe que el filtro no esté desgastado o dañado, cámbielo si es necesario.
- Aplicar aceite específico para filtros en toda la superficie del filtro (3) y luego exprimirlo para eliminar el exceso de aceite.
- Vuelva a montar el filtro (3) en la tapa (2).

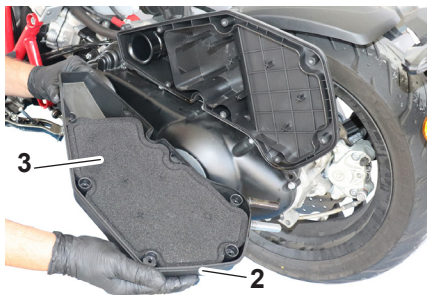

- Compruebe el estado de la junta (4), sustitúyala si está dañada.

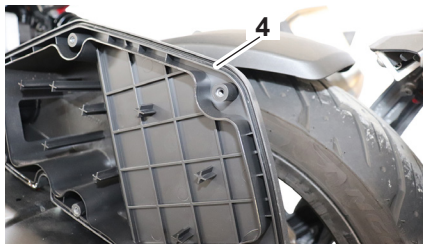

- Vuelva a colocar la tapa del filtro (2) apretando los tornillos (1).

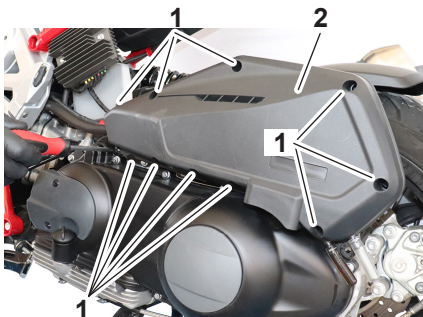

- Compruebe que los respiraderos (5) y (6) no estén sucios; si observa suciedad, quítelos, límpielos y móntelos de nuevo.

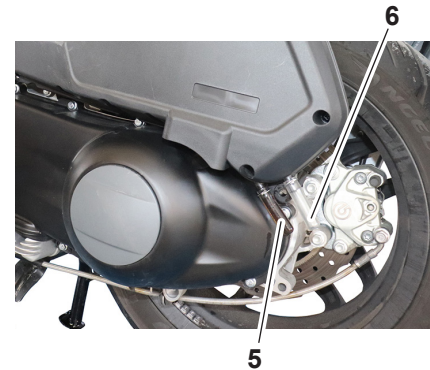



5.1.f Limpieza del filtro de aire de la transmisión

- Destornillar los tornillos (1) y quitar la tapa (2).

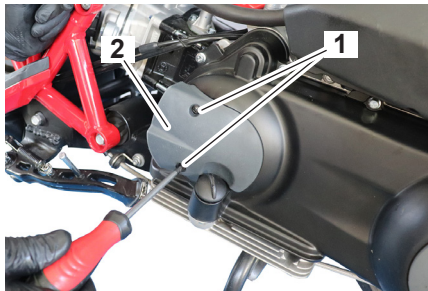

- Quitar el filtro (3) y limpiarlo con detergentes adecuados.

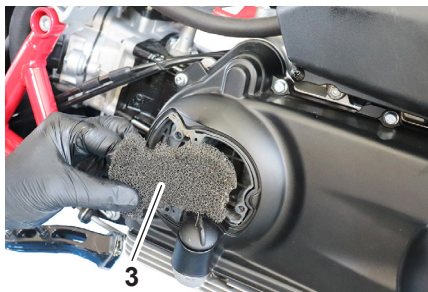

⚠ ADVERTENCIA

No utilice gasolina u otros disolventes inflamables para limpiar el filtro.

- Compruebe que el filtro no esté desgastado o dañado, cámbielo si es necesario.
- Compruebe el estado de la junta (4) y sustitúyala si está dañada.

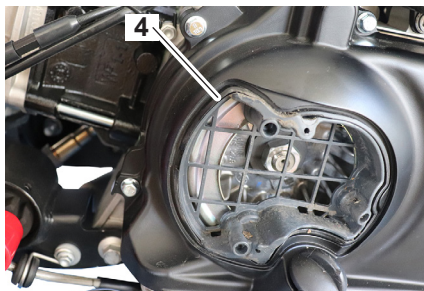

- Vuelva a montar el filtro (3) y la tapa (2) realizando las operaciones de desmontaje en orden inverso.

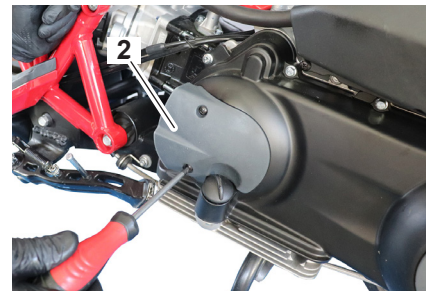



5.1.g Comprobación de la bujía

⚠ ADVERTENCIA

Espere hasta que el motor se haya enfriado antes de realizar el control; peligro de quemaduras.

- Retirar la tapa (1).
- Con la llave adecuada, quitar la bujía (2).

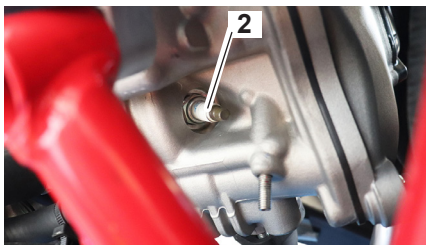

La distancia entre los electrodos de las bujías (2) debe ser de $0,5 \div 0,6$ mm. Una distancia diferente puede provocar un mal funcionamiento de la motocicleta.

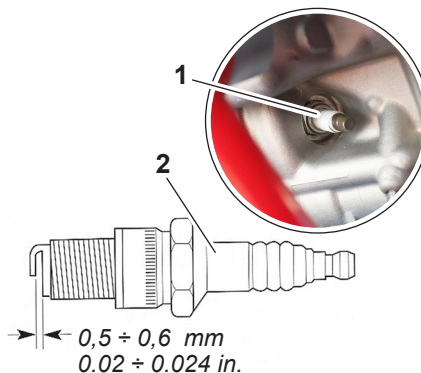

5.1.h Comprobación neumáticos y presión relativa

Es esencial mantener siempre los neumáticos en buenas condiciones y reemplazarlos en los intervalos adecuados con neumáticos de acuerdo con las especificaciones.

Compruebe siempre y, si es necesario, ajuste la presión de los neumáticos antes de partir.

⚠ ADVERTENCIA

El uso de la motocicleta con una presión de neumáticos incorrecta puede provocar lesiones graves o la muerte como resultado de la pérdida de control.

- Compruebe y ajuste la presión de los neumáticos cuando esté frío (es decir, cuando la temperatura de los neumáticos sea igual a la temperatura ambiente).
- La presión de los neumáticos debe ajustarse de acuerdo con el peso total del ciclista, pasajero, carga y accesorios aprobados para este modelo.



5.1.i Inspección de neumáticos

Esta motocicleta está equipada con neumáticos sin cámara.

- Controlar el estado de los neumáticos, no deben tener grietas, abrasiones, etc., controlar también el desgaste de la banda de rodadura mediante los indicadores especiales del propio neumático.

ALTURA MÍNIMA DE LA PISADA

PARTE DELANTERA	2 mm (0.08 in)
TRASERO	2 mm (0.08 in)

- Controlar la presión según las indicaciones dadas en el apartado de datos técnicos.

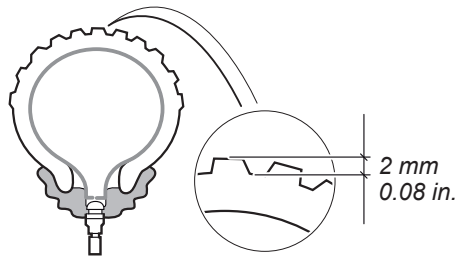

⚠ ADVERTENCIA

Los neumáticos delanteros y traseros deben ser de la misma marca y modelo, el uso de diferentes tipos de neumáticos entre las ruedas delanteras y traseras compromete la estabilidad de la motocicleta y su maniobrabilidad.

NOTA: Los neumáticos envejecen incluso si no están desgastados visualmente; Las grietas laterales o deformaciones de la carcasa son un signo de envejecimiento. Haga que un distribuidor de neumáticos revise los neumáticos antes de utilizar la motocicleta.

Presión de los neumáticos en frío:

1 persona:

Parte delantera:
190 kPa (1.9 Kgf/cm², 28 psi)

Trasero:
200 kPa (2.00 kgf/cm², 29 psi)

2 personas:

Parte delantera:
210 kPa (2.10 kgf/cm², 30 psi)

Trasero:
250 kPa (2.50 kgf/cm², 36 psi)

- Para ajustar la presión, quitar el tapón (1) y conectar el manómetro a la válvula (2).

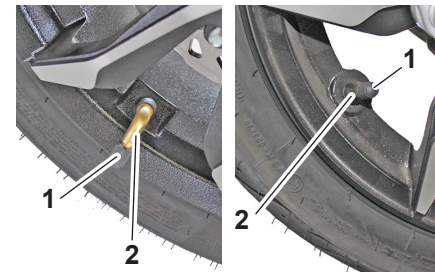



⚠ ADVERTENCIA

- **Reemplace los neumáticos excesivamente gastados por un distribuidor de neumáticos. El uso del vehículo con neumáticos excesivamente gastados reduce la estabilidad de conducción y puede provocar la pérdida de control del vehículo.**
- **Conduzca a velocidad moderada después de cambiar una llanta, para permitir que la superficie de la llanta “se asiente”, de modo que pueda desarrollar al máximo sus características.**

NOTA: Al reemplazar un neumático, es necesario equilibrar la rueda.

Antes de cada uso, compruebe siempre que las llantas no tengan grietas, dobleces, deformaciones u otros daños. Si encuentra algún daño, cambie la rueda. No intente hacer ni la más mínima reparación en una rueda. En caso de deformaciones o grietas, se debe reemplazar la rueda.

5.1.I Comprobación del desgaste de las pastillas de freno

Compruebe el desgaste de las pastillas de freno delanteras (1) y las pastillas de freno traseras (2).

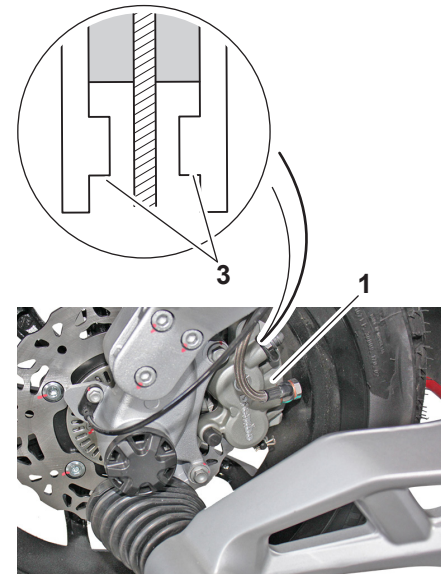



- Las pastillas están equipadas con un indicador de desgaste (3). Para comprobar el desgaste de las pastillas, compruebe la posición del indicador de desgaste (3) mientras aplica el freno. Si una pastilla se ha desgastado hasta el punto que el indicador de desgaste casi toca el disco de freno, reemplace las pastillas por pares.

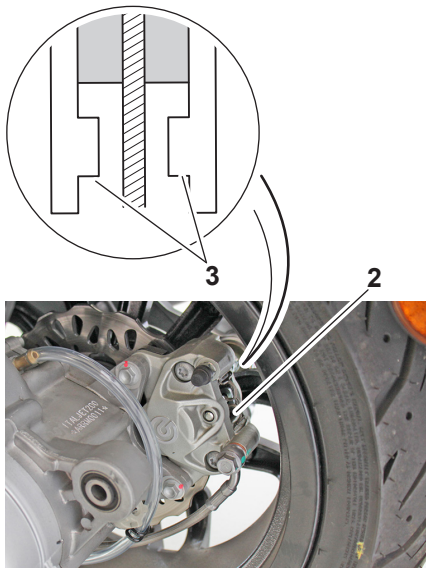

⚠ ADVERTENCIA

Para reemplazar las pastillas de freno, es necesario contactar a un distribuidor *Italjet*.

⚠ ADVERTENCIA

Después de reemplazar las pastillas de freno, es necesario conducir con cuidado, frenando gradualmente para permitir que las pastillas se asienten correctamente / se acoplen a los respectivos discos.





5.1.m Comprobación del nivel de líquido de frenos delantero / trasero

- Posicionar la motocicleta de forma que la parte superior del depósito del freno quede paralela al suelo.
- El nivel de líquido en el tanque de la bomba debe estar en el centro del borde (1).

Cualquier descenso del nivel de líquido puede permitir la entrada de aire en el sistema con el consiguiente alargamiento de la carrera de la palanca; si es necesario recargar, póngase en contacto con su distribuidor *Italjet*.

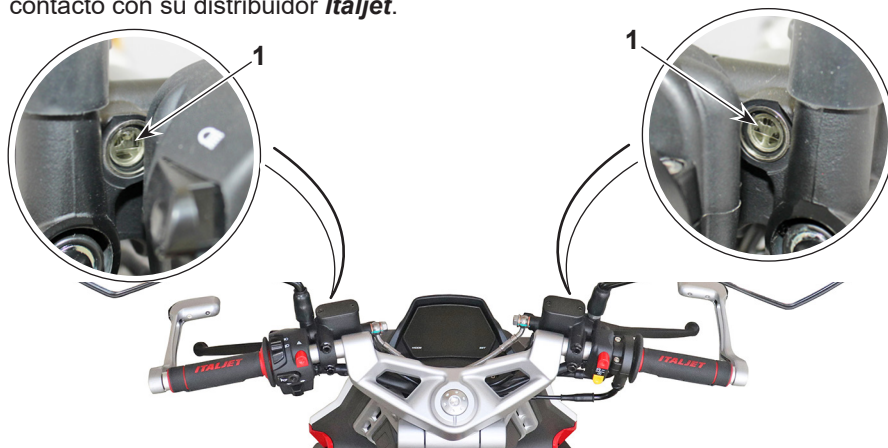

⚠ ADVERTENCIA

Si la palanca de freno está demasiado "blanda", hay aire en la tubería o un defecto del sistema. Dado que es peligroso conducir la motocicleta en estas condiciones, haga que su distribuidor *Italjet* revise inmediatamente el sistema de frenos.

ATENCIÓN

No vierta líquido de frenos en superficies pintadas o lentes (por ejemplo, faros)

⚠ ADVERTENCIA

No mezcle dos tipos diferentes de líquido. Si opta por utilizar una marca diferente de líquido, elimine por completo el existente.

⚠ ADVERTENCIA

El líquido de frenos puede causar irritación. Evite el contacto con la piel y los ojos. En caso de contacto, limpiar completamente la zona afectada y, si son los ojos, llamar a un médico.





⚠ ADVERTENCIA

- Utilice únicamente el líquido de frenos prescrito de acuerdo con la especificación; de lo contrario, las juntas de goma pueden deteriorarse y provocar fugas.
- Rellenar con el mismo tipo de líquido de frenos. La adición de un líquido de frenos que no sea DOT 4 puede provocar una reacción química nociva.
- Evite la infiltración de agua o polvo en el depósito del líquido de frenos durante el repostaje. El agua provoca una reducción significativa en el punto de ebullición del líquido y puede causar un "bloqueo de vapor", y la suciedad puede obstruir las válvulas de la unidad hidráulica del ABS.

ATENCIÓN

El líquido de frenos puede dañar las superficies pintadas o las piezas de plástico. Siempre limpie inmediatamente cualquier líquido derramado.

A medida que se desgastan las pastillas de freno, es normal que el nivel del líquido de frenos baje gradualmente. Si el nivel de líquido de frenos es bajo, es posible que las pastillas de freno estén desgastadas y / o que haya una fuga en el circuito de frenos; por tanto, asegúrese de comprobar el nivel de desgaste de las pastillas de freno y la presencia de fugas en el circuito de freno.

Si el nivel del líquido de frenos baja repentinamente, haga que un distribuidor *Italjet* revise el vehículo antes de continuar usándolo.

5.1.n Cambio del líquido de frenos

Solicite a un distribuidor *Italjet* que cambie el líquido de frenos cada 2 años. Además, haga que los sellos de los cilindros maestros y las pinzas de freno, así como las mangueras de freno, sean reemplazados en los intervalos que se enumeran a continuación o antes si están dañados o tienen fugas.

- Sellos de freno: cada 2 años
- Mangueras de freno: cada 4 años

5.1.o Comprobación de la correa traapezoidal

La correa traapezoidal debe ser revisada y / o reemplazada por un distribuidor *Italjet* en los intervalos especificados en el cuadro de mantenimiento periódico.



5.1.p Comprobación y lubricación del caballete central y lateral

Siempre verifique periódicamente el funcionamiento del caballete central y del caballete lateral, y lubrique los pasadores guía (1) y las superficies de contacto metal con metal si es necesario.

ADVERTENCIA

Si el caballete central o lateral no sube o baja fácilmente, haga que un distribuidor *Italjet* lo revise o repare.

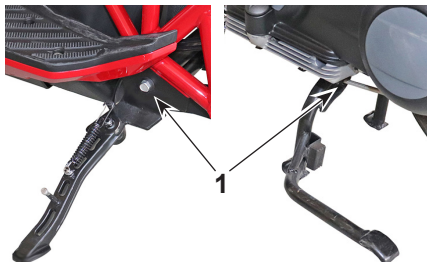

5.1.q Ajuste de la precarga del resorte del amortiguador

El amortiguador delantero (1) y el trasero (2) permiten ajustar la precarga del resorte; para ello, afloje la contratuerca (3) y actúe en la tuerca anular (4), enroscándola para aumentar la precarga y desenroscándola para disminuirla.

Enroscando la tuerca anular, el resorte se comprime y por lo tanto se obtiene una acción amortiguadora más rígida. Al desenroscar la tuerca anular, se libera el resorte y, por lo tanto, tendrá una acción de amortiguación más suave.

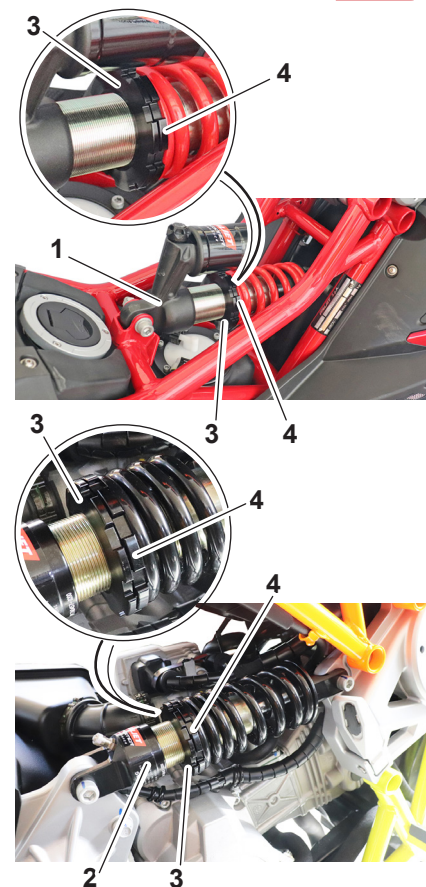



5.1.r Ajuste frenado amortiguador delantero

- Ajuste el frenado actuando en la tuerca anular (1): girándola hacia "+", el frenado aumenta y girándola hacia "-", el frenado disminuye.

La configuración de fábrica es de 6 clics desde el cierre total.

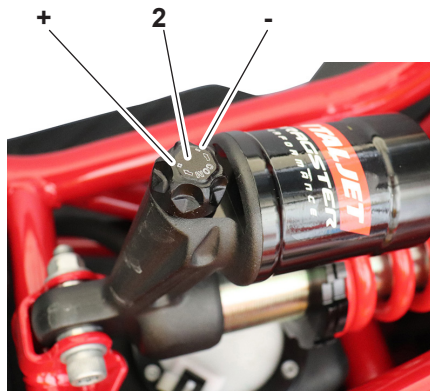

5.1.s Comprobación de la columna de dirección delantera

La columna de dirección debe revisarse periódicamente para detectar cualquier juego.

- Colocar la motocicleta en el caballete central, una persona debe sujetar el manillar de la motocicleta para que quede estable y otra persona debe intentar mover la rueda (1) en el sentido de la flecha "A" y en el sentido de la flecha "B".



Si se encuentra un juego excesivo, póngase en contacto con un distribuidor *Italjet* para comprobar el movimiento de la dirección (2).

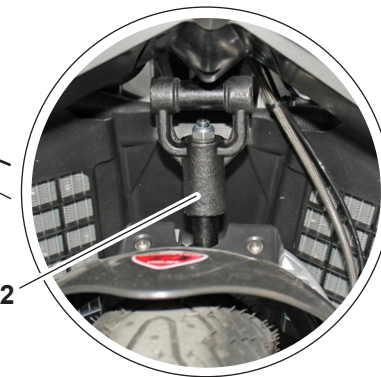



5.1.t Comprobación y carga de la batería

Para acceder al compartimento de la batería, proceda de la siguiente manera:

- Levantar el sillín como se describe en el párrafo relativo;
- Destornille los dos tornillos (1) y retire el asiento del pasajero (2);

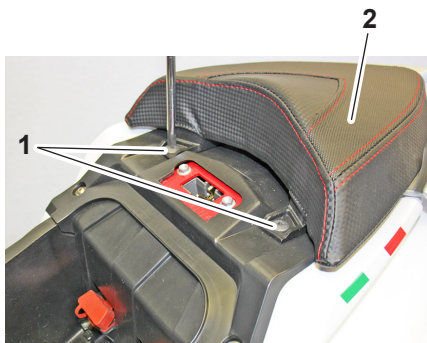

- Destornille los dos tornillos (3) y retire la carcasa (4).



- Primero retire el cable negativo NEGRO (5) luego el cable positivo ROJO (6) (al volver a montar, conecte primero el cable positivo ROJO, luego el negativo NEGRO);
- Saque la batería (7) de su alojamiento.

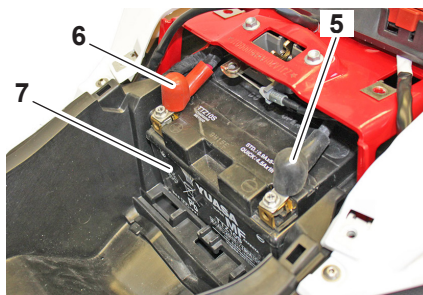

- Verificar, con la ayuda de un voltímetro, que la tensión del mismo no sea inferior a 12,5V. De lo contrario, la batería necesita un ciclo de recarga.

- Utilizando un cargador de batería de voltaje constante, primero conecte el cable positivo ROJO al terminal positivo de la batería y luego el negativo NEGRO al terminal negativo de la misma.

- Compruebe siempre el estado de carga de la batería antes de volver a instalarla en el vehículo. La batería debe mantenerse limpia y los terminales engrasados.

>>>





- Vuelva a montar todo procediendo en orden inverso al desmontaje, cuidando de encajar el gancho (8) del asiento del pasajero en el asiento (9) del soporte.

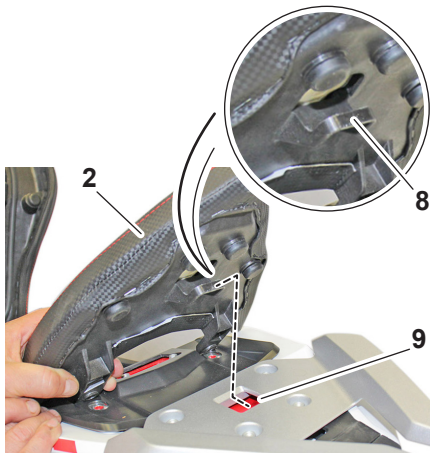

! PELIGRO

La batería contiene ácido sulfúrico. Evite el contacto con la piel, ojos y ropa.

REMEDIOS:

CONTACTO CON LA PIEL

Enjuague abundantemente con agua.

INGESTIÓN:

Beba grandes cantidades de agua y leche.

Llame a un médico de inmediato. No induzca el vomito.

CONTACTO VISUAL

Enjuague con agua durante al menos 15 minutos y llame a un médico.

ATENCIÓN

Si la batería no está en uso, en cualquier caso debe recargarse con un ciclo de carga lento (0,6 A durante 8 horas para la batería de 12V-6Ah) al

menos cada 3 semanas.

! ADVERTENCIA

Las baterías producen gases explosivos, ventile la habitación cuando cargue la batería en interiores. Cuando utilice un cargador de batería, conecte la batería al cargador antes de encenderlo. Esta práctica evita la formación de chispas en los terminales de la batería que podrían encender los gases contenidos en la batería.



5.1.u Comprobación / sustitución de fusible

La motocicleta está equipada con dos cajas de fusibles, una ubicada debajo del asiento y otra ubicada debajo del panel frontal.

Fusibles debajo del asiento

- Levantar el sillín para acceder a la caja de fusibles (1).

Fusible 2 (20 A) = motor ABS

Fusible 3 (15 A) = válvula ABS

Fusible 4 (10 A) = Positivo, tablero de instrumentos, regulador de voltaje, inyección

Fusible 5 (20 A) = Fusible de repuesto

Fusible 6 (15 A) = Fusible de repuesto

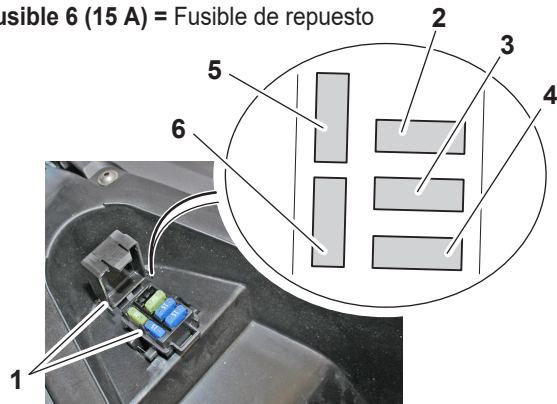

Fusibles debajo del panel frontal

- Destornille los tornillos (1) y retire el panel superior (2).

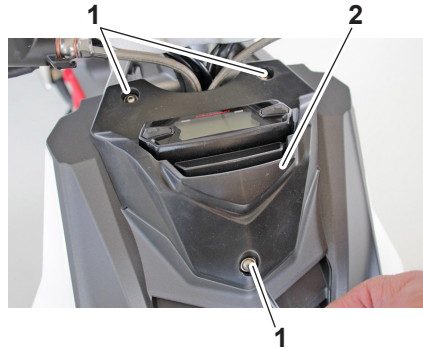

- Tirar levemente del panel (3) hacia afuera para soltarlo desde la parte superior.



- Coger el panel (3) con ambas manos y tirar de él hacia fuera hasta que se suelte del soporte.

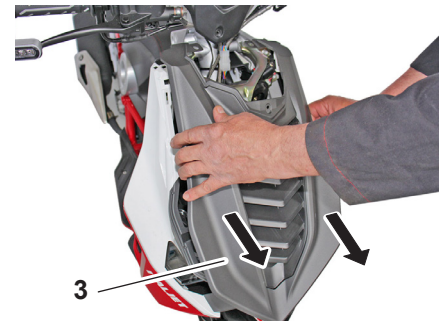



- La caja de fusibles (4) se encuentra en la parte superior derecha de la motocicleta.

Fusible 5 (15A) = luces, luz de matrícula, relé de intermitente, bocina

Fusible 6 (15A) = Inyección, motor de arranque

Fusible 7 (15A) = fusible de repuesto

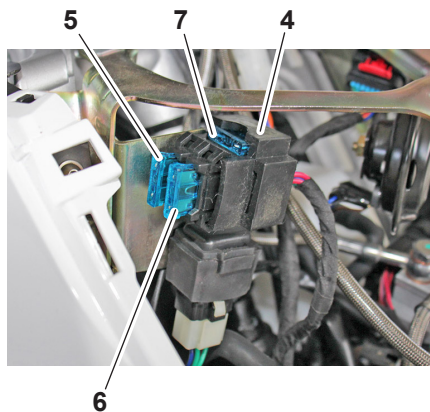

- Remontar todo procediendo en orden inverso al desmontaje, cuidando de encajar los topes (8) del panel (3) en sus asientos (9).

ATENCIÓN

No utilice un fusible con un amperaje superior al original, podría provocar daños en el sistema eléctrico y posible incendio.

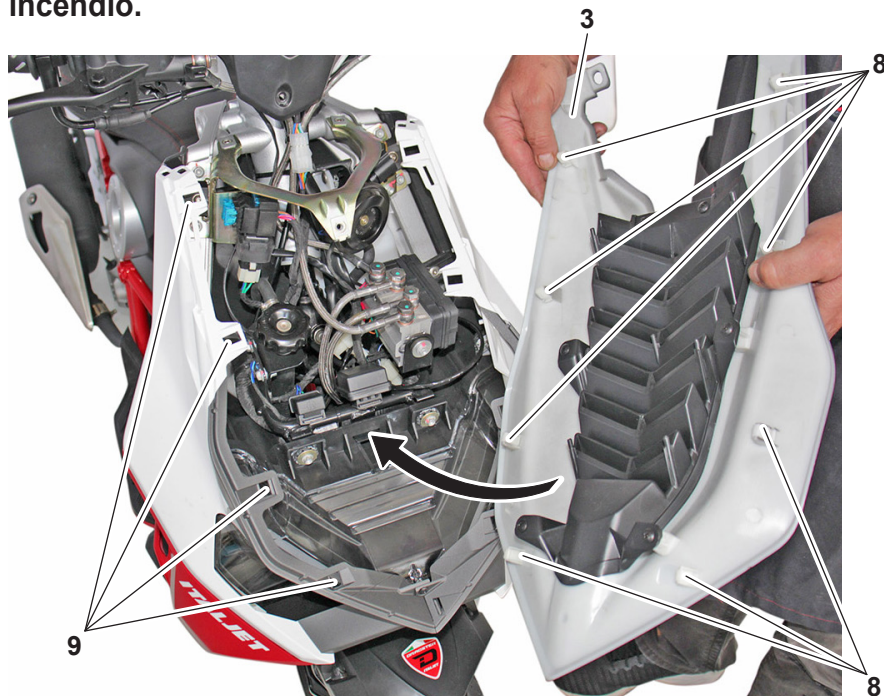



5.1.v Control de iluminación

Control de haz de luz frontal

- Para comprobar si la luz está orientada correctamente, coloque la motocicleta, con los neumáticos inflados a la presión adecuada y con una persona sentada en el sillín, perfectamente perpendicular a su eje longitudinal.
- Frente a una pared o una pantalla, a 10 metros de ella, trazar una línea horizontal correspondiente a la altura del centro de la luz y una línea vertical en línea con el eje longitudinal del vehículo.

- Realice la comprobación si es posible con poca luz.
- Al encender la luz de carretera, el límite superior de demarcación entre el área oscura y el área iluminada debe estar a una altura que no exceda $\frac{9}{10}X$ de la altura desde el suelo del centro del proyector.
- Para realizar el ajuste correcto, acuda a un distribuidor **Italjet**.

Luces e indicadores de dirección

- La motocicleta está equipada con luces e indicadores LED, si una luz no funciona debe ser reemplazada acudiendo al concesionario **Italjet**.

Conectores de diagnóstico

Para acceder a los conectores de diagnóstico, levante el sillín.

- Conector (1) = Centralita ABS
Conector (2) = Unidad de control del motor

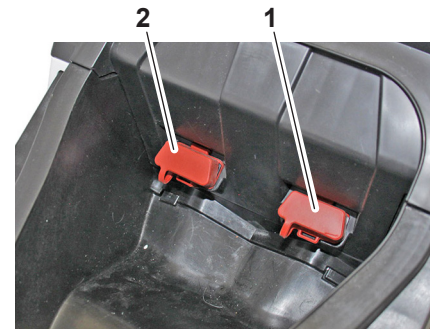
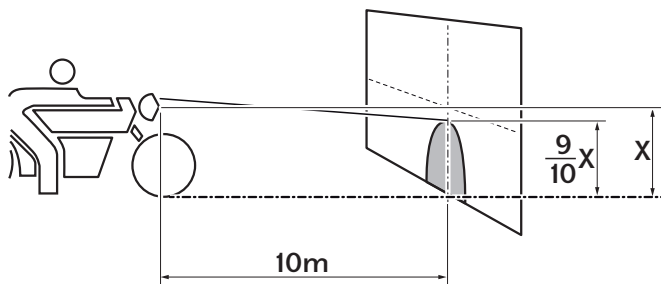



6.1 MANTENIMIENTO Y ALMACENAMIENTO DE LA MOTOCICLETA

6.1.a Mantenimiento

La limpieza frecuente y profunda del vehículo, además de mejorar su apariencia, también mejorará su rendimiento general y extenderá la vida útil de muchos componentes. Además, lavar, limpiar y pulir te permitirá inspeccionar el estado del vehículo con más frecuencia. Lave el vehículo después de usarlo bajo la lluvia o cerca del mar, ya que la sal es corrosiva para los metales.

NOTA: Las carreteras en áreas propensas a nevadas intensas se pueden rociar con sal para evitar que se congelen. Esta sal puede permanecer en las carreteras hasta finales de la primavera, así que lave la parte inferior y los componentes del chasis después de usar el vehículo en tales áreas.

ADVERTENCIA

Una limpieza inadecuada puede provocar daños estéticos y mecánicos. No utilice:

- Limpiadoras de alta presión o limpiadoras a vapor. Una presión de agua excesiva podría provocar la penetración de agua y el deterioro de los cojinetes de las ruedas, los frenos, los sellos de la transmisión y los dispositivos eléctricos.
- Productos químicos agresivos, agentes limpiadores abrasivos o ceras en componentes con acabado satinado. Los cepillos pueden rayar y dañar el acabado satinado; use solo esponjas o toallas suaves.

- Toallas, esponjas o cepillos contaminados con productos de limpieza abrasivos o químicos agresivos, como disolventes, gasolina, inhibidores de óxido, líquido de frenos, anticongelante, etc.



6.1.b Lavado

Antes

1. Estacione la motocicleta fuera de la luz solar directa y deje que se enfríe.
Esto evitará que se formen manchas de cal.
2. Verifique que todos los enchufes, cubiertas, conectores y elementos de conexión eléctrica estén instalados correctamente.
3. Tenga cuidado de que no penetre agua en el interior del silenciador.
4. Elimine la suciedad de la carretera y las manchas de aceite con un desengrasante de calidad y un cepillo con cerdas de plástico o una esponja.

Durante

1. Enjuague los restos de desengrasante con agua corriente. Evite rociar agua directamente en el silenciador, en el panel de instrumentos, en la entrada de aire o dentro de otras áreas internas, como los compartimentos de almacenamiento debajo del sillín.
2. Lave la motocicleta con un limpiador de automóviles de calidad mezclado con agua dulce y una esponja suave. Utilice un cepillo de dientes usado o un cepillo con cerdas de plástico para limpiar los lugares de difícil acceso.

ATENCIÓN

Si la motocicleta ha estado expuesta a la sal, utilice agua fría. El agua caliente aumentará las propiedades corrosivas de la sal.

3. Enjuague bien con agua limpia. Elimine todos los residuos de detergente; podría ser perjudicial para los componentes plásticos.

Después

1. Seque la motocicleta completamente.
2. Pulir las superficies de cromo, aluminio y acero inoxidable con un producto específico.
3. Aplique spray anticorrosión a todos los componentes metálicos, incluidas las superficies cromadas o niqueladas.

ADVERTENCIA

No aplique aerosoles de silicona o aceite a los sillines, empuñaduras, soportes de goma para los reposapiés, discos de freno o bandas de rodadura de los neumáticos. De lo contrario, los componentes se volverán resbaladizos, lo que podría hacer que pierda el control del vehículo. Limpie a fondo las superficies de estos componentes antes de usar el vehículo.



4. Trate los componentes de caucho, vinilo y plástico sin pintar con un producto de cuidado adecuado.
5. Extienda una cera no abrasiva en todas las superficies pintadas.
6. Después de la limpieza, arranque el motor y déjelo funcionar al ralentí durante unos minutos para secar la humedad residual.
7. Deje que el vehículo se seque completamente antes de guardarlo o cubrirlo.

ADVERTENCIA

Las materias extrañas que quedan en los frenos o los neumáticos pueden hacer que pierda el control del vehículo.

- **Asegúrese de que no haya lubricante ni cera en los frenos o neumáticos.**
- **Si es necesario, lave los neumáticos con agua tibia y un detergente neutro.**
- **Si es necesario, limpie los discos y pastillas de freno con un limpiador en aerosol especial.**
- **Después de lavar la motocicleta, pruebe la eficacia de los frenos.**

6.1.c Almacenamiento

Guarde siempre el vehículo en un lugar fresco y seco. Si es necesario, protéjalo del polvo cubriéndolo con una hoja permeable.

Asegúrese de que el motor y el sistema de escape se hayan enfriado antes de cubrir la motocicleta.

ATENCIÓN

Para evitar la corrosión, evite los sótanos húmedos, los refugios para animales (debido a la presencia de amoníaco) y los entornos donde se almacenan productos químicos fuertes.



6.1.d Almacenamiento prolongado

Antes de almacenar el vehículo durante un período de tiempo prolongado (60 días o más), haga lo siguiente:

1. Realice los trabajos de mantenimiento.
2. Limpiar la motocicleta.
3. Llene el tanque de combustible agregando estabilizador de combustible de acuerdo con las instrucciones del producto.
Haga funcionar el motor durante 5 minutos para distribuir el combustible tratado por todo el sistema de combustible.
4. Lubrique el caballete lateral (si está equipado) y el caballete central.
5. Compruebe y restablezca la presión de los neumáticos y luego levante el vehículo de modo que las ruedas no toquen el suelo.
6. Cubra el desagüe con una bolsa de plástico para evitar que entre humedad.
7. Retire la batería y cárguela completamente, o conecte un cargador de mantenimiento para mantener una carga óptima de la batería.

ATENCIÓN

Compruebe que la batería y su cargador sean compatibles.

NOTA: Si va a quitar la batería, cárguela una vez al mes y guárdela en un lugar templado donde la temperatura sea de 0-30 ° C (32-90°F).



7.1 DATOS TÉCNICOS

Longitud máxima	1885 mm
Ancho máximo	750 mm
Altura máxima	1075 mm
Altura del sillín	760 mm
Distancia entre ejes	1350 mm
Altura mínima desde el suelo	120 mm
Peso en vacío (peso vacío)	150 kg
Carga máxima del vehículo (conductor + pasajero + equipaje)	305 kg
A toda velocidad	124 km/h
Aceite de motor	1300 cm ³ (primer llenado) 1250 cm ³ (Reemplace el aceite del motor y el filtro) 1200 cm ³ (Cambiar solo aceite de motor)
Aceite de la transmisión	250 cm ³
Refrigerante	1.15 l (50% agua + 50% líquido anticongelante etilenglicol)
Asientos	2
Intercambio	variador automático continuo
Transmisión	reductor de velocidad y correa
Chasis	Estructura de acero tubular de alta resistencia, viga delantera simple, cuna superpuesta trasera doble.
Ángulo de dirección	27.5°

>>>>>





Suspensión delantera	Sistema de dirección independiente
Recorrido de la suspensión delantera	33 mm
Suspensión trasera	Amortiguador mono
Recorrido de la suspensión trasera	47 mm
Disco delantero	Freno de disco de Ø 200 mm con transmisión hidráulica
Disco trasero	Freno de disco de Ø 220 mm con transmisión hidráulica
Llantas de ruedas	Llantas de aleación ligera
Llanta de la rueda delantera	MT 3.50 x 12"
Llanta de la rueda trasera	MT 4.00 x 13"
Tipo de llanta	Sin cámara de aire (Tubeless)
Neumático delantero	120/70 - 12" 51 P (120/70-12 M/C, 58S)
Llanta trasera	140/60-13" M/C 63P (140/60-13 M/C 63S)
Presión de inflado estándar de los neumáticos delanteros	190 kPa (1.9 bar)
Presión de inflado estándar de los neumáticos traseros	200 kPa (2.0 bar)
Presión de inflado estándar de los neumáticos delanteros con pasajero	210 kPa (2.1 bar)
Presión de inflado estándar de los neumáticos traseros con pasajero	250 kPa (2.5 bar)
Batería	12V - 8.6Ah
Fusibles	20 - 15 - 15 - 15 - 15 - 10 A
Alternador (tipo imán permanente)	12 V - 300W a 8000 rpm



Datos técnicos del motor (300CC)

Modelo de motor	AZC
Tipo motore	Monocilíndrico, 4 tiempos, refrigerado por líquido, 4 válvulas por cilindro y un árbol de levas en culata
Potencia neta máx.	17 kW (8000 r/min)
Par máximo	23 N•m (6000 r/min)
Desplazamiento	278 cc
Diámetro / carrera	75 mm x 63 mm
Índice de compresión	11 : 1
Encendido	Elettrico
Régimen mínimo	1700 ± 170 rpm
Embrague	Embrague seco centrífugo automático
Transmisión	Automático
Refrigeración	Sistema de refrigeración líquida con radiador y ventilador eléctrico.
Inyeccion	Inyeccion electronica
Difusor del cuerpo del acelerador	Ø 32 mm
Combustible	Gasolina súper sin plomo, octanaje mínimo de 95 (NORM)
Tipo de encendido	Electrónico
Bujía	NGK CR8EKB



8.1 TABLA DE PRODUCTOS RECOMENDADO

Producto	Descripción	Características
Aceite del motor semisintético o sintético	Aceite de motor	SAE 5W-40 JASO MA, MA2 API SL ACEA A3
Aceite del motor semisintético o sintético	Aceite de la transmisión	SAE 80W/90 75W/90 GL-4 / GL-5
Lubricante L-XCDBB2	Grasa de litio con molibdeno para cojinetes y otros puntos que requieran lubricación	NLGI 2
Líquido de frenos DOT4	Líquido de los frenos	FMVSS DOT4
Refrigerante del motor FD-2B	Refrigerante O.A.T.	Protección anticongelante hasta -40 ° C. Cumple con la norma CUNA 956-16.
Lubricante / aceite de motor 5W-30	Aceite de esponja para filtro de aire	-
GRASA NEUTRA O GASOLADA	Poli batteria	-



ES - 70





9.1 LIBRO DE GARANTÍA Y SERVICIO





9.1.a El contenido de la garantía

Su motocicleta nueva está garantizada libre de defectos originales de acuerdo con la **Directiva 99/44 CE**. La garantía consiste en la sustitución o reparación gratuita del vehículo o de componentes que presenten, dentro del plazo antes mencionado, defectos de fabricación o, en todo caso, defectos preexistentes a la entrega del vehículo.

La garantía solo es válida si su vehículo ha seguido el programa de mantenimiento recomendado y todos los cupones han sido sellados correctamente.

Te recordamos que la garantía no aplica en el caso de uso del vehículo en carreras de motos, ya que es un uso diferente y no compatible con el uso para el que tu vehículo fue diseñado específicamente.

Recuerde que, como exige la ley, esta garantía la brinda directamente su Distribuidor **Italjet**, con quien lo invitamos a contactar para cualquier necesidad.

Si su distribuidor Italjet no puede satisfacer sus solicitudes en un tiempo razonable o si esto le resulta más conveniente, le invitamos a que se ponga en contacto con cualquier otro distribuidor **Italjet**, que estará encantado de estar a su servicio.

9.1.b Activación de la garantía

Su vehículo está cubierto por una garantía contra defectos originales desde el momento en que su concesionario **Italjet** se lo entrega.

Cuando reciba su vehículo **Italjet**, lo invitamos a firmar, junto con el Concesionario, el Certificado de Entrega del Vehículo que se encuentra en este manual.

9.1.c Qué hacer en caso de reclamación de garantía

En el caso de que, durante el período de garantía, su vehículo requiera una reparación y / o reemplazo extraordinarios debido a un defecto original, le recomendamos que se comunique de inmediato con el Concesionario donde compró el vehículo (su Concesionario) describiendo el problema ocurrido y teniendo él examinará el vehículo.

Si la intervención se hace necesaria por la aparición de un defecto original, su Distribuidor realizará la reparación o sustitución necesaria sin cargo en el menor tiempo posible.

9.1.d Condiciones de garantía

Exclusiones

Quedan excluidos de la garantía:

- Deterioro resultante del incumplimiento del plan de mantenimiento periódico prescrito por **Italjet**.
- Vehículos cuyas reparaciones se han realizado con repuestos que no se ajustan al original.
- Vehículos para los que no se ha realizado el plan de mantenimiento periódico o para los que los cupones no han sido debidamente sellados.
- Vehículos utilizados para carreras / alquiler / uso pesado todoterreno.

Consumibles y piezas de desgaste:

La garantía no cubre el desgaste normal causado por el uso del vehículo para las siguientes partes:

- Bujías.
- Cadena de distribución.
- Pastillas y discos de freno.
- Discos y masas de embrague.
- Neumáticos.
- Lámparas y fusibles.
- Cables de transmisión y control.
- Tubos y todas las demás piezas de goma.
- Rodamientos.
- Filtro de aire y gasolina.
- Correa y engranajes de la transmisión secundaria.



Lubricantes

La garantía no cubre líquidos: aceite, grasa, ácido de batería y refrigerante.

Limitaciones

Para todos los vehículos: la garantía de la BATERÍA, el ASIENTO y los PLÁSTICOS está limitada a 6 meses.

- La garantía no cubre los costos de mantenimiento y revisión, ni el costo de las piezas necesarias para estas operaciones.
- La garantía no cubre los costos derivados de la aplicación de la garantía tales como: costos adicionales de comunicaciones, cualquier alojamiento y comida, u otros costos derivados como compensación por tiempo perdido, pérdidas comerciales, costos de alquiler de vehículos de reemplazo, transporte.

Nota importante para la vigencia de la garantía:

- El folleto de garantía debe conservarse con cuidado y presentarse al distribuidor oficial de **Italjet** en cada intervención.
- Los cupones de inspección deben ser cumplimentados por el Concesionario que realizó la intervención.
- La garantía se puede transferir a los propietarios posteriores hasta su vencimiento.
- En caso de cambio de propietario, utilice el cupón especial que se encuentra en este folleto.
- El fabricante se reserva el derecho a realizar cambios y / o mejoras en todos sus modelos sin la obligación de realizar estos cambios en los vehículos que ya están en circulación.





Area containing multiple horizontal dotted lines, likely serving as a guide for text or graphics.





CERTIFICADO DE ENTREGA

Fecha:

N° de chasis:

Modelo:

N° Motor:

La motocicleta ha sido preparada para la entrega mediante la realización de todas las comprobaciones y operaciones previas a la entrega previstas por ITALJET S.P.A. y se completa con los accesorios opcionales solicitados por el Cliente.

El cliente ha recibido este folleto de garantía y el manual de uso y mantenimiento y se han ilustrado los principales dispositivos de conducción suministrados con el vehículo.

Sello y firma del distribuidor

La organización oficial de ventas y la empresa ITALJET SPA declaran que el procesamiento de los datos personales del comprador, con referencia a la Ley No. 675 de 1996 y modificaciones posteriores, también puede tener lugar sin la necesidad del consentimiento del Cliente, en cumplimiento de la obligación de prestar el Servicio de Asistencia.

CLIENTE

Nombre:

Apellido:

Dirección:

Ciudad:

CÓDIGO POSTAL:

Número de teléfono:

Declaro recibir hoy la motocicleta arriba indicada completa y de acuerdo con mis expectativas, así como declaro recibir este Folleto de Garantía y el Manual de Uso y Mantenimiento. Autorizo a ITALJET S.P.A. al tratamiento de mis datos personales con la finalidad de prestar el Servicio de Asistencia de conformidad con la Ley 675/1996 y posteriores modificaciones.

Firma del cliente

Copia para ITALJET S.P.A.



Area containing multiple horizontal dotted lines, likely serving as a guide for text or data entry.





COMUNICACIÓN DE TRANSFERENCIA DE PROPIEDAD

Fecha: Km:

N° de chasis:

Modelo:

N° Motor:

El abajo firmante: _____

Nombre: _____

Apellido: _____

Dirección: _____

Ciudad: _____ CÓDIGO POSTAL: _____

Número de teléfono: _____

Envíe en sobre cerrado a:
ITALJET S.P.A. , Via dell'agricoltura, 2 - 40023 Castel Guelfo di Bologna (BO) - Italia

La organización oficial de ventas y la empresa ITALJET SPA declaran que el procesamiento de los datos personales del comprador, con referencia a la Ley N ° 675 de 1996 y modificaciones posteriores, también puede tener lugar sin la necesidad del consentimiento del Cliente, en cumplimiento de la obligación de prestar el Servicio de Asistencia.



CLIENTE



Notificar a ITALJET S.P.A. quien hoy transfirió la propiedad del mencionado vehículo al Sr.

Nombre: _____

Apellido: _____

Dirección: _____

Ciudad: _____

CÓDIGO POSTAL: _____

Número de teléfono: _____

entregando este Folleto de garantía y el Manual de uso y mantenimiento suministrados.

Copia para ITALJET S.P.A.





Area containing multiple horizontal dotted lines, likely serving as a guide for text or graphics.





Espacio para guardar la documentación fiscal que acredite la exitosa ejecución de los cupones de mantenimiento programados



CUPÓN	<input type="text"/>	FECHA	<input type="text"/>	Km	<input type="text"/>	Firma del Cliente	<input type="text"/>	Sello de distribuidor	<input type="text"/>
CUPÓN	<input type="text"/>	FECHA	<input type="text"/>	Km	<input type="text"/>	Firma del Cliente	<input type="text"/>	Sello de distribuidor	<input type="text"/>
CUPÓN	<input type="text"/>	FECHA	<input type="text"/>	Km	<input type="text"/>	Firma del Cliente	<input type="text"/>	Sello de distribuidor	<input type="text"/>
CUPÓN	<input type="text"/>	FECHA	<input type="text"/>	Km	<input type="text"/>	Firma del Cliente	<input type="text"/>	Sello de distribuidor	<input type="text"/>
CUPÓN	<input type="text"/>	FECHA	<input type="text"/>	Km	<input type="text"/>	Firma del Cliente	<input type="text"/>	Sello de distribuidor	<input type="text"/>
CUPÓN	<input type="text"/>	FECHA	<input type="text"/>	Km	<input type="text"/>	Firma del Cliente	<input type="text"/>	Sello de distribuidor	<input type="text"/>
CUPÓN	<input type="text"/>	FECHA	<input type="text"/>	Km	<input type="text"/>	Firma del Cliente	<input type="text"/>	Sello de distribuidor	<input type="text"/>
CUPÓN	<input type="text"/>	FECHA	<input type="text"/>	Km	<input type="text"/>	Firma del Cliente	<input type="text"/>	Sello de distribuidor	<input type="text"/>
CUPÓN	<input type="text"/>	FECHA	<input type="text"/>	Km	<input type="text"/>	Firma del Cliente	<input type="text"/>	Sello de distribuidor	<input type="text"/>
CUPÓN	<input type="text"/>	FECHA	<input type="text"/>	Km	<input type="text"/>	Firma del Cliente	<input type="text"/>	Sello de distribuidor	<input type="text"/>

FIJAR con un clip o grapadora el Recibo Fiscal o Recibo que certifique que se han realizado los cupones de mantenimiento.







DE

DEUTSCH

Italjet lehnt jede Verantwortung für eventuelle Fehler bei der Zusammenstellung dieses Handbuchs ab und behält sich das Recht vor, Änderungen vorzunehmen, die aufgrund der laufenden Entwicklung seiner Produkte erforderlich sind. Die gezeigten Abbildungen sind dienen zur Veranschaulichung und entsprechen möglicherweise nicht genau der jeweiligen Gegenständen. Auch eine teilweise Vervielfältigung dieses Handbuches ist ohne schriftliche Genehmigung untersagt.





DRAGSTER

A large, stylized red letter 'D' with a white outline, positioned below the word 'DRAGSTER'. The 'D' is composed of a thick red horizontal bar on the left and a curved red shape on the right that forms the letter's bowl.

DE - 2





INDEX

1.1 EINLEITUNGDE - 5	2.6 BEFEHLEDE - 19	3.1 ÜBERPRÜFUNGEN VOR DER VERWENDUNGDE - 30
1.2 WICHTIGE WARNHINWEISEDE - 5	2.6.a ZündschlossDE - 19	3.2 GEBRAUCHSANWEISUNG DES FAHRZEUGSDE - 32
1.3 SYMBOLE IN DIESEM HANDBUCHDE - 6	2.6.b Lenkschloss „lock“.....DE - 20	3.2.a Einfahrhinweise.....DE - 32
1.4 SICHERES FAHREN UND MOTORRADSICHERHEITDE - 7	2.7 LINKER STEUERBLOCKDE - 21	3.2.b Identifizierung von BetriebsstörungenDE - 32
1.5 ANTIBLOCKIERSYSTEM – ABSDE - 8	2.8 RECHTER STEUERBLOCKDE - 22	3.3 AUFSTEIFEN/ABSTEIFEN VON FAHRER UND BEIFAHRE R.....DE - 33
1.6 RISIKEN IM ZUSAMMENHANG MIT KOHLENMONOXIDDE - 8	2.8.a Notausschalter zum Abstellen des Motors.....DE - 22	3.3.a Allgemeine RegelnDE - 33
1.7 SICHERHEITSHINWEISEDE - 9	2.8.b MotorstartknopfDE - 22	3.3.b Aufstieg des Fahrers.....DE - 33
1.7.a Zubehör.....DE - 9	2.9 GASDREHGRIF F.....DE - 22	3.3.c Aufstieg des Beifahrers.....DE - 34
1.7.b Transport des Rollers.....DE - 9	2.10 BEDIENUNG DER VORDERRADBREMSEDE - 23	3.3.d Abstieg vom Fahrzeug.....DE - 35
1.7.c Klappbarer SchlüsselDE - 9	2.11 BEDIENUNG DER HINTERRADBREMSEDE - 23	3.4 EINSTELLUNG DER RÜCKSPIEGELDE - 35
2.1 KOMPONENTEN DES FAHRZEUGSDE - 10	2.12 KRAFTSTOFFTANKDE - 24	4.1 STARTEN DES FAHRZEUGSDE - 36
2.2 BEDIENELEMENTE UND INSTRUMENTEDE - 13	2.13 KRAFTSTOFFDE - 25	4.1.a Verwendung des Gasdrehgriffs.....DE - 37
2.3 DATEN ZUR IDENTIFIZIERUNGDE - 14	2.13.a Verschiedene Arten von BenzinDE - 25	4.1.b Verwendung der Bremsen.....DE - 37
2.4 INSTRUMENTENTAFELDE - 15	2.13.b KatalysatorDE - 26	4.1.c Abstellen von Fahrzeug und MotorDE - 38
2.4.a Kontroll- und WarnleuchtenDE - 15	2.14 ZUBEHÖRTEILE UND USB-BUCHSEDE - 26	
2.4.b Digitalanzeige.....DE - 17	2.14.a Verwenden der USB-Buchse.....DE - 26	
2.5 EINSTELLUNGEN UND ANZEIGEEINSTELLUNGENDE - 18	2.14.b Staufach unter dem SattelDE - 27	
	2.14.c SeitenständerDE - 28	
	2.14.d Hauptständer.....DE - 29	





4.1.d Abstellen des Motors
im Notfall DE - 38

4.1.e Abstellen des
Fahrzeugs DE - 38

**5.1 WARTUNG UND
REGELMÄSSIGE
KONTROLLEN DE - 39**

5.1.a Regelmäßige
Wartung DE - 39

5.1.b Ölstandskontrolle DE - 43

5.1.c Motoröl- und
Filterwechsel DE - 43

5.1.d Kühlmittelstandkontrolle... DE - 46

5.1.e Motorluftfilterreinigung... DE - 46

5.1.f Getriebe- und Luftfilterreinigung... DE - 48

5.1.g Zündkerzenprüfung DE - 49

5.1.h Reifen- und
Reifendruckprüfung DE - 49

5.1.i Reifenkontrolle DE - 50

5.1.l Verschleiß der
Bremsbeläge prüfen DE - 51

5.1.m Bremsflüssigkeitsstand
vorne/hinten prüfen DE - 53

5.1.n Bremsflüssigkeit
wechseln DE - 54

5.1.o Keilriemen prüfen DE - 54

5.1.p Hauptständer und
Seitenständer prüfen und
schmieren DE - 55

5.1.q Einstellung der
Federvorspannung der
Stoßdämpfer DE - 55

5.1.r Einstellung des
vorderen
Bremsstoßdämpfers DE - 56

5.1.s Lenksäulenprüfung
vorne DE - 56

5.1.t Batterie prüfen und
laden DE - 57

5.1.u Kontrolle/Austausch von
Sicherungen DE - 59

5.1.v Lichtsteuerung DE - 61

**6.1 PFLEGE UND LAGERUNG
DES FAHRZEUGS DE - 62**

6.1.a Pflege DE - 62

6.1.b Waschen DE - 63

6.1.c Lagerung DE - 64

6.1.d Längere Lagerung DE - 65

7.1 TECHNISCHE DATEN DE - 66

**8.1 TABELLE DER
EMPFOHLENE
PRODUKTE DE - 69**

**9.1 GARANTIE- UND
SERVICEBUCH DE - 71**

9.1.a Inhalt der Garantie DE - 72

9.1.b Inbetriebnahme des
Fahrzeugs DE - 72

9.1.c Verhalten im
Garantiefall DE - 72

9.1.d Garantiebedingungen DE - 72



1.1 EINLEITUNG

Willkommen in der *Italjet*-Motorradfamilie!

Ihr *Italjet*-Roller wurde so konzipiert und gebaut, dass er der Beste in seiner Kategorie ist. Die Anweisungen in diesem Handbuch wurden erstellt, um eine einfache und klare Anleitung für die Verwendung und Wartung des Motorrads zu geben. Um die beste Leistung zu erzielen, wird empfohlen, die Anweisungen in diesem Handbuch sorgfältig zu befolgen. Es enthält Anweisungen zur Durchführung der erforderlichen Wartungsarbeiten. Speziellere und aufwändigere Reparaturen oder Wartungsarbeiten erfordern die Arbeit von erfahrenen Mechanikern und die Verwendung geeigneter Geräte. Es ist ratsam, sich an das offizielle *Italjet*-Netzwerk zu wenden, das über alle Tools verfügt, um dem Kunden den besten Service zu bieten.

AUFMERKSAMKEIT

Beachten Sie, dass diese "Bedienungs- und Wartungsanleitung" als integraler Bestandteil des Motorrads zu betrachten ist und als solcher auch beim Weiterverkauf an diesem angebracht bleibt.

Dieses Motorrad verwendet Komponenten, die mit modernsten Systemen und Technologien entwickelt und hergestellt wurden. Für den korrekten Betrieb des Motorrads ist es notwendig, die Inspektions- und Wartungstabelle in diesem Handbuch zu befolgen.



1.2 WICHTIGE WARNHINWEISE

Die *DRAGSTER*-Modelle sind Motorräder für den STRASSENEINSATZ, die durch eine vertragliche Garantie abgedeckt sind, vorausgesetzt, dass DIE STANDARDKONFIGURATION GEWARTET WIRD und die Wartungsarbeiten eingehalten werden.



1.3 SYMBOLE IN DIESEM HANDBUCH

Besonders wichtige Informationen werden durch die folgenden Symbole hervorgehoben

 GEFAHR	GEFAHR wird verwendet, um auf mögliche Verletzungsgefahren aufmerksam zu machen. Befolgen Sie alle Sicherheitshinweise, die diesem Symbol folgen, um Verletzungen oder Tod zu vermeiden.
 WARNUNG	WARNUNG weist auf eine gefährliche Situation hin, die zum Tod oder zu schweren Verletzungen führen kann, wenn sie nicht vermieden wird.
ACHTUNG	ACHTUNG weist auf besondere Vorsichtsmaßnahmen hin, die getroffen werden müssen, um Schäden am Fahrzeug zu vermeiden.
HINWEIS	<i>HINWEIS</i> enthält wichtige Informationen zum jeweiligen Kapitel.



1.4 SICHERES FAHREN UND MOTORRADSI- CHERHEIT

Nachfolgend listen wir einige Grundprinzipien für das sichere Fahren Ihres Fahrzeugs auf.

- Denken Sie daran, dass Ihre Sicherheit und die der Passagiere an erster Stelle stehen. Das sichere Ankommen am Ende der Reise muss das oberste Ziel sein.
- Fahrer und Beifahrer müssen geeignete Schutzkleidung wie Overall, Handschuhe, Schuhe, Motorradhelm tragen.
- Die Position des Fahrers auf dem Roller muss so sein, dass Sie eine möglichst breite Sicht auf die Straße haben, auf der Sie fahren.
- Fahren Sie das Fahrzeug vorsichtig, passen Sie die Geschwindigkeit entsprechend dem Verkehr und der Straßenbeschaffenheit an. Eine ruhige Fahrt ermöglicht es Ihnen, Gefahren einzuschätzen und Kurvenfahrten präziser zu steuern.
- Achten Sie immer auf die Warnschilder und passen Sie die Geschwindigkeit gemäß den angegebenen Hinweisen an.
- Beachten Sie immer die Geschwindigkeitsbegrenzungen.
- Bewerten Sie immer den Zustand der Straßenoberfläche und passen Sie die Geschwindigkeit entsprechend an.
- Begrenzen Sie Ihre Geschwindigkeit bei Regen und insbesondere bei Pfützen auf dem Asphalt.
- Halten Sie beim Fahren auf nassen oder wenig griffigen Oberflächen (Schnee, Eis, Schlamm usw.) eine mäßige Geschwindigkeit ein und vermeiden Sie plötzliches Bremsen und andere plötzliche Manöver.
- Halten Sie einen Sicherheitsabstand zu Fahrzeugen vor Ihnen ein.
- Kontrollieren Sie vor dem Überholen, dass sich vor dem zu überholenden Fahrzeug keine Hindernisse befinden und kontrollieren Sie immer durch die Rückspiegel, dass sich keine anderen Fahrzeuge von hinten nähern.
- Gleichzeitiges Bremsen mit Vorder- und Hinterradbremse trägt zur Stabilität des Fahrzeugs bei.
- Wenn Sie sich müde oder schläfrig fühlen, halten Sie an und ruhen Sie sich aus.
Eine kontinuierliche Verwendung der Bremsen bergab kann zu einer Überhitzung der Bremsbeläge führen, wodurch die Bremswirkung eingeschränkt wird.
- Beim Bergabfahren den Motor nicht abstellen.
- Erhöhen Sie bei Fahrten mit Beifahrer die Sicherheitsabstände zu vorausfahrenden Fahrzeugen und berücksichtigen Sie dessen Gewicht beim Bremsen, in Kurven oder beim Überholen.
- Die Position von Fahrer und Beifahrer ist wichtig für die Kontrolle des Fahrzeugs.
- Während der Fahrt muss der Fahrer beide Hände am Lenker und beide Füße auf den Fußrasten lassen, um die Kontrolle über das Fahrzeug zu behalten.
- Der Beifahrer muss sich immer mit beiden Händen am Fahrer oder am Griff festhalten und beide Füße auf den Fußrasten lassen. Befördern Sie niemals einen Beifahrer, der nicht beide Füße fest auf den Fußrasten abstellen kann.
- Fahren Sie niemals unter Einfluss von Alkohol oder Drogen.
- Dieses Fahrzeug ist nur für den Straßenverkehr bestimmt. Es ist nicht für den Offroad-Einsatz geeignet.
- Verwenden Sie keine Schnürsenkel, Seile usw., um das Gepäck zu sichern. Verwenden Sie nur zugelassene Taschen, die für den von Ihnen verwendeten Fahrzeugtyp geeignet sind.
- Die maximal zu transportierende Last (Fahrer, Beifahrer und Gepäck) darf 155 kg (342 lb.) nicht überschreiten. Unter keinen Umständen darf das Gewicht des Gepäcks 5 kg überschreiten.





1.5 ANTIBLOCKIERSYSTEM – ABS

ABS ist ein elektromechanisches Bremshilfesystem.

Es verhindert das Blockieren der Räder beim Bremsen und trägt so zur Stabilität des Fahrzeugs bei rutschigen, nassen oder schmutzigen Straßenoberflächen bei.

Bei schlechter Haftung kann das System eingreifen, indem es den Bremsweg verlängert (z. B. bei Kies oder rutschiger Oberfläche), garantiert jedoch in jedem Fall den kürzest möglichen Bremsweg für die jeweilige Straßenoberfläche.

- Das ABS-System funktioniert nicht bei Geschwindigkeiten unter 10 km/h.

Wenn das ABS-System beim Bremsen eingreift geht, sind Pulsationen am Bremshebel zu spüren: Dieses Gefühl sollte nicht dazu führen, dass der Druck am Hebel nachlässt, da dies die Wirkung des Systems aufheben würde.

Darüber hinaus darf das Vorhandensein des ABS-Systems nicht zu Verhaltensweisen oder Fahrverhalten führen, die die üblichen Vorsichtsregeln überschreiten.

- Verwenden Sie immer die empfohlenen Beläge und Reifen, um den korrekten Betrieb des ABS-Systems zu gewährleisten.

1.6 RISIKEN IM ZUSAMMENHANG MIT KOHLENMONOXID

Abgase enthalten Kohlenmonoxid, ein farb- und geruchloses Gas. Das Einatmen von Kohlenmonoxid kann Bewusstlosigkeit und Tod verursachen.

Wird der Motor in ganz oder teilweise geschlossenen Räumen gestartet, kann die Atemluft gefährlich viel Kohlenmonoxid enthalten. Starten Sie das Motorrad niemals in einer Garage oder einem anderen geschlossenen Or.

! GEFAHR

Kohlenmonoxid ist ein giftiges Gas. Das Einatmen kann zu Bewusstlosigkeit und zum Tod führen. Vermeiden Sie alle Bereiche oder Aktivitäten, die Sie Kohlenmonoxid aussetzen könnten.



1.7 SICHERHEITSHINWEISE

1.7.a Zubehör

Die Auswahl des richtigen Zubehörs für Ihr Fahrzeug ist eine wichtige Entscheidung. Verwenden Sie nur Originalzubehör, das bei **Italjet**-Händlern erhältlich ist und für die Verwendung in Ihrem Fahrzeug getestet und freigegeben wurde.

Das Hinzufügen von elektrischem Zubehör muss mit Vorsicht erfolgen. Wenn das elektrische Zubehör die Kapazität des Elektroniksystems des Fahrzeugs überschreitet, kann es zu einem Ausfall des Elektroniksystems führen.

1.7.b Transport des Rollers

Bevor Sie Ihren Roller in einem anderen Fahrzeug transportieren, beachten Sie bitte die folgenden Hinweise.

- Entfernen Sie alle losen Gegenstände vom Roller.
- Richten Sie das Vorderrad in Laufstellung geradlinig auf dem Anhänger oder auf der Ladefläche aus und verriegeln Sie es entsprechend gegen Verschieben.
- Sichern Sie den Roller mit geeigneten Seilen oder Befestigungsgurten an festen Bauteilen des Rollers selbst, wie z. B. dem Rahmen (und nicht z. B. an den Fahrtrichtungsanzeigern oder anderen bruchgefährdeten Bauteilen). Wählen Sie die Position der Gurte sorgfältig aus, damit sie beim Transport nicht an lackierten Teilen reiben.
- Die Federung sollte nach Möglichkeit teilweise eingefedert sein, damit der Roller beim Transport nicht zu stark ruckelt.

1.7.c Klappbarer Schlüssel

Der Schlüssel (1) des Dragsters ist klappbar.

Um ein Brechen zu vermeiden, wird empfohlen, den Griff des Schlüssels (1) während der Fahrt senkrecht zum Schlüssel selbst zu klappen.





2.1 KOMPONENTEN DES FAHRZEUGS

Rechte Seitenansicht

1. Fahrerfußrasten
2. Fahrersitz
3. Beifahrersitz
4. Beifahrergriffe
5. Beifahrerfußrasten
6. Hinterer Stoßdämpfer
7. Auspuffschalldämpfer
8. Handschuhfach





Linke Seitenansicht

1. Vorderrad
2. vordere Bremsscheibe
3. vorderer Bremssattel
4. Vorderer Einzelarm
5. Einarmiger Stoßdämpfer
6. Schloss zum Untersattelfach
7. Spannungsregler
8. Motor
9. Luftfilterkasten
10. Hauptständer
11. Getriebeluftfilter
12. hintere Bremsscheibe und hinterer Bremssattel
13. Hinterrad
14. Treibstofftankdeckel
15. Treibstofftank
16. Seitlicher Ständer





Vorder- und Rückansicht

1. Rechter Rückspiegel
2. Linker Rückspiegel
3. Vorderer, rechter Fahrtrichtungsanzeiger
4. vorderer, linker Fahrtrichtungsanzeiger
5. Frontlicht
6. Rechter Kühler
7. Linker Kühler
8. Rücklichter
9. Hinterer, linker Fahrtrichtungsanzeiger
10. Hinterer, rechter Fahrtrichtungsanzeiger
11. Kennzeichenbeleuchtung
12. Kennzeichenhalter

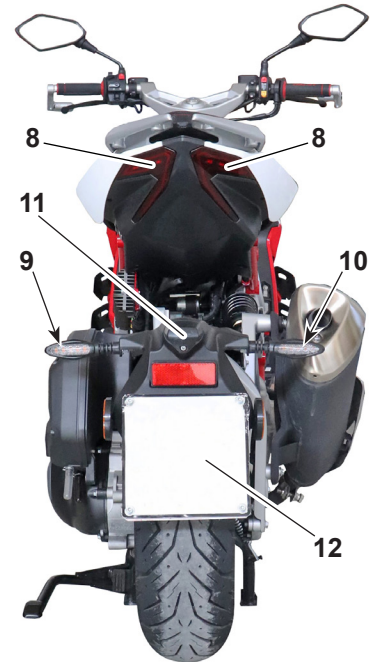



2.2 BEDIENELEMENTE UND INSTRUMENTE

1. Linker Lenkergriff
2. Linker Steuerblock
3. Hinterradbremsehebel
4. Gasgriff
5. Rechter Steuerblock
6. Vorderradbremsehebel
7. Zündschloss
8. USB-Buchse
9. Digitale
Instrumentenanzeige





2.3 DATEN ZUR IDENTIFIZIERUNG

Die Motorseriennummer ist auf der Rückseite/Oberseite des Kurbelgehäuses eingestanzt, während die Fahrzeugseriennummer auf dem Rahmen unter der Sitzbank eingestanzt ist.

Beachten Sie bei der Bestellung von Ersatzteilen oder der Anfrage nach Informationen zu Ihrem Motorrad immer die auf **dem Rahmen eingestanzte Nummer**, und notieren Sie diese auch in dieser Broschüre.

FAHRZEUGSERIENNUMMER

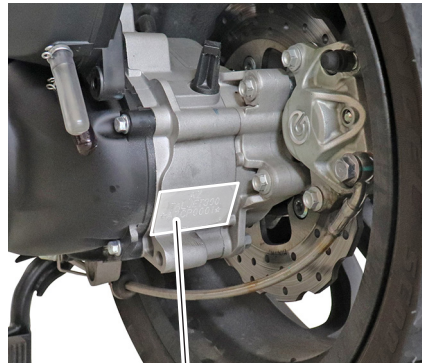

2

MOTORSERIENNUMMER



1



2.4 INSTRUMENTENTAFEL

2.4.a Kontroll- und Warnleuchten

- 1) Warnleuchte Fahrtrichtungsanzeiger links.
- 2) Warnleuchte Fahrtrichtungsanzeiger rechts.
- 3) Warnleuchte für unzureichenden Motoröldruck.
- 4) Fernlicht-Warnleuchte.
- 5) Warnleuchte für hohe Kühlmitteltemperatur.
- 6) Warnleuchte für niedrigen Kraftstoffstand.
- 7) ABS-Warnleuchte.
- 8) Motorstörungswarnleuchte.

Warnleuchte Fahrtrichtungsanzeiger links “←”

Das Licht blinkt, wenn der linke Fahrtrichtungsanzeiger mit dem entsprechenden Steuerinstrument am linken Steuerblock eingesetzt wird.

Warnleuchte Fahrtrichtungsanzeiger rechts “→”.

Das Licht blinkt, wenn der rechte Fahrtrichtungsanzeiger mit dem entsprechenden Steuerinstrument am linken Steuerblock eingesetzt wird.

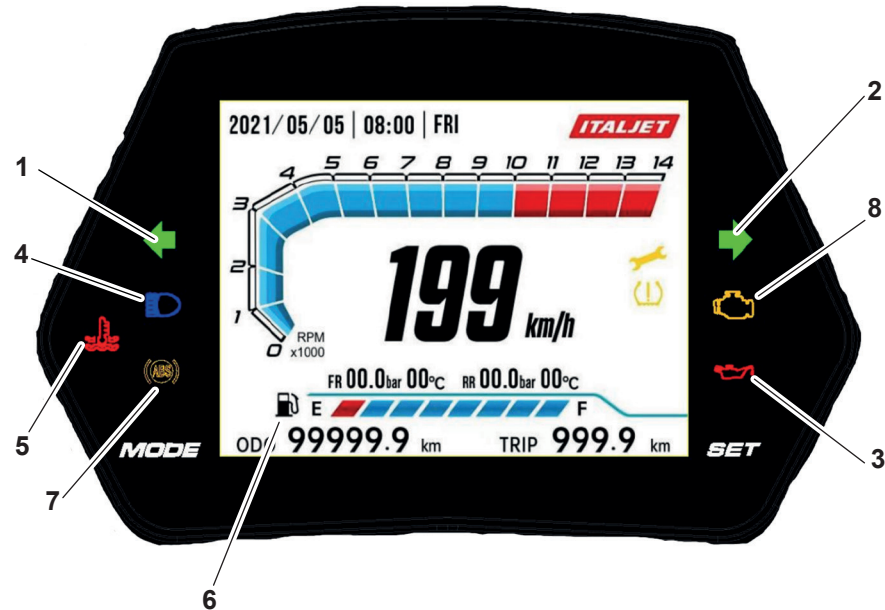

Warnleuchte für unzureichenden Motoröldruck “”.

Sie leuchtet bei Zündschlüsselstellung „ON“ und sollte bei laufendem Motor erlöschen. Wenn sie bei laufendem Motor an bleibt oder auf-

leuchtet, stellen Sie den Motor ab und prüfen Sie den Ölstand wie im entsprechenden Absatz beschrieben oder wenden Sie sich an Ihren Händler, um den Fehler überprüfen zu lassen.





ACHTUNG

Verwenden Sie das Fahrzeug nicht mit unzureichendem Öldruck, ansonsten riskieren Sie womöglich einen Motorschaden.

Fernlicht-Warnleuchte “”.

Das Licht geht an, wenn das Fernlicht mit dem entsprechenden Steuerinstrument am linken Steuerblock eingeschaltet wird.

Warnleuchte für hohe Kühlmitteltemperatur “”.

Sie leuchtet auf, wenn die Kühlmitteltemperatur den maximal zulässigen Wert erreicht hat.

ACHTUNG

Stoppen Sie das Motorrad und stellen Sie den Motor ab. Verwenden Sie das Motorrad nicht mit einer hohen Kühl-

mitteltemperatur, ansonsten riskieren Sie womöglich einen Motorschaden.

- Warten Sie, bis das Kühlmittel abgekühlt ist, und überprüfen Sie dann den Stand wie im entsprechenden Abschnitt beschrieben, oder wenden Sie sich an einen Händler Ihres Vertrauens, um den Fehler zu überprüfen.

Warnleuchte für niedrigen Kraftstoffstand “”

Wenn die Kontrollleuchte während der Fahrt aufleuchtet, bedeutet dies, dass der Kraftstoffstand den Reservestand (2 Liter) erreicht hat, was auf eine eingeschränkte Reichweite hindeutet; so schnell wie möglich tanken.

ABS-Warnleuchte “”

Durch Drehen des Schlüssels führt das ABS-Steuergerät eine Eigendiagnose durch, die Kontrollleuchte leuchtet für einige Sekunden auf und erlischt dann, um keine Auffälligkeiten anzuzeigen.

Wenn die Kontrollleuchte dagegen

während der Fahrt aufleuchtet, liegt ein Fehler im ABS-Bremssystem vor:

- Stoppen und den Motor abstellen ;
- Warten Sie einige Minuten und starten Sie den Motor neu. Wenn die Warnleuchte wieder aufleuchtet, wenden Sie sich an den nächsten **Italjet**-Händler, um das ABS-System überprüfen zu lassen.

Motorstörungswarnleuchte “”

Durch Drehen des Zündschlüssels führt das Motorsteuergerät eine Eigendiagnose durch, die Kontrollleuchte leuchtet für einige Sekunden auf und erlischt dann, um keine Auffälligkeiten anzuzeigen.

Wenn die Kontrollleuchte bei laufendem Motor aufleuchtet, liegt eine Störung des Motors oder der Einspritzanlage vor;

- Stoppen und den Motor abstellen ;
- Warten Sie einige Minuten und starten Sie den Motor neu. Wenn die Warnleuchte wieder aufleuchtet, wenden Sie sich an den nächsten **Italjet**-Händler, um eine Überprüfung des Eigendiagnosesystems durchzuführen.



2.4.b Digitalanzeige

- 1) Geschwindigkeitsanzeige (Tachometer) km/h - mi/h.
- 2) Datum / Uhrzeit / Tag.
- 3) Kraftstoffanzeige.
- 4) Gesamtanzeige km/Meilen.
- 5) Teilanzeige km/Meilen.
- 6) Anzeige für fälligen Wartungstermin.
- 7) "MODE"-Taste.
- 8) "SET"-Taste.

Geschwindigkeitsanzeige (1)

Zeigt die Geschwindigkeit des Motorrads an; die Geschwindigkeit kann in km/h oder mi/h angezeigt werden, je nachdem wie die Maßeinheit eingestellt wurde.

Datum/Uhrzeit/Wochentag (2)

- 2a) Zeigt das Datum an; kann mit „Jahr/Monat/Tag“ oder „Tag/Monat/Jahr“ angezeigt werden
- 2b) Zeigt die Uhrzeit an; kann entweder auf eine 24-Stunden- oder 12-Stunden-Skala eingestellt werden.
- 2c) Zeigt den Wochentag an.

Kraftstoffanzeige (3)

Zeigt den Kraftstoffstand im Tank an; vollständig sichtbare Skala (3a) zeigt den maximalen Füllstand an, nicht sichtbare Skala (3a) zeigt den minimalen

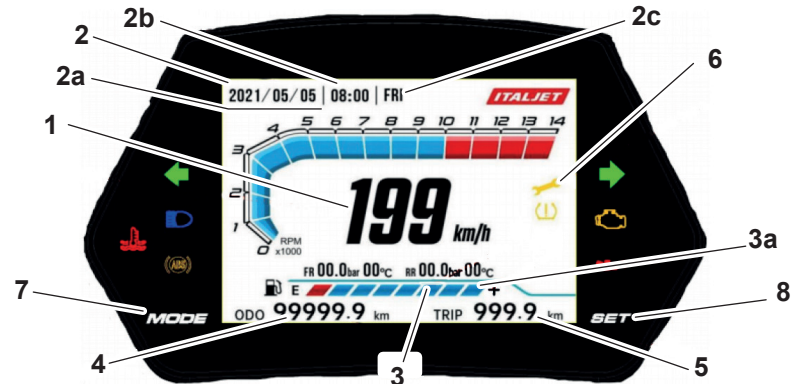

Füllstand an, das Licht „“ leuchtet.

Gesamtanzeige km/Meilen (4).

Dieser Teil des Displays zeigt die Gesamtzahl der gefahrenen km/Meilen an.

Teilanzeige km/Meilen (TRIP) (5)

Dieser Teil des Displays zeigt die seit dem letzten Zurücksetzen gefahrenen km/Meilen an.

Anzeige für fälligen Wartungstermin (6)

Die Anzeige blinkt, sobald der Wartungstermin noch 100km / 62mi entfernt ist. Der Wartungshinweis bleibt per-

manent, wenn die km/mi des Wartungsintervalls überschritten wurden und erlischt erst nach dem Zurücksetzen.

Nach der Durchführung der Wartung auf TOTAL ODO umstellen, dann die Taste „*mode*“ (7) länger als 10 Sekunden drücken; die Wartungsanzeige erlischt.

MODE-Taste (7)

Mit der „*mode*“-Taste können Sie durch die Software scrollen.

SET-Taste (8)

Mit der „*set*“-Taste können Sie die Maßeinheit einstellen und Teilzähler löschen.



2.5 EINSTELLUNGEN UND ANZEIGEEINSTELLUNGEN

! GEFAHR

Alle Einstellungen müssen bei stehendem Motorrad vorgenommen werden.

Einstellung der Anzeige in km/mi und der Uhr in 24/12 Stunden

- Drücken Sie die „**Mode**“-Taste, bis die Gesamtkilometer/Gesamtmeilen angezeigt werden.
- Halten Sie die „**Set**“-Taste mindestens zehn Sekunden lang gedrückt, um von der Maßeinheit km + 24-Stunden-Uhr zu mi (Meilen) + 12-Stunden-Uhr und umgekehrt zu wechseln; die Teilzähler werden zurückgesetzt.

Zeiteinstellung

- Drücken Sie die Tasten „**Mode**“ und „**Set**“ gleichzeitig länger als zwei Sekunden, die Stunden und Minuten beginnen zu blinken.
- Drücken Sie die Taste „**Mode**“, um die Stunden zu erhöhen, und die Taste „**Set**“, um die Minuten zu erhöhen.
- Drücken Sie die Tasten „**Mode**“ und „**Set**“ gleichzeitig länger als zwei Sekunden, um die Zeiteinstellung zu bestätigen.

Einstellung von km/mi und Teilstunden "Trip A oder Trip B"

- Drücken Sie die „**Mode**“-Taste, bis „**Trip A**“ oder „**Trip B**“ angezeigt wird; durch kurzes Drücken der „**Set**“-Taste können Sie zwischen der Anzeige der gefahrenen Teilkilometer zu den Teilstunden der Fahrt umschalten.
- Um die gefahrenen Teilkilometer und die Teilzeit zurückzusetzen, drücken Sie die „**Set**“-Taste länger als zwei Sekunden; die Werte werden zurückgesetzt und eine neue Zählung beginnt erneut.





2.6 BEFEHLE

2.6.a Zündschloss

Der Zündschloss hat drei Positionen:

- ↻ Fahrzeugstartposition (Schlüssel nicht abziehbar);
- ⊗ Schlüsselabzugsposition;

„**LOCK**“ Sperrstellung der Lenkung (abziehbarer Schlüssel).

- Schlüsselabzugsposition “⊗”

Durch Drehen des Schlüssels in die Position „⊗“ schalten sich Motor und Licht aus und es ist möglich, den Schlüssel aus dem Schloss zu ziehen

- Ausgangsposition “↻”

Von Position „⊗“ (Schlüsselabzug) den Schlüssel (1) im Uhrzeigersinn auf Position „↻“ drehen; die Lichter und das Display leuchten auf und das Fahrzeug kann gestartet werden.





2.6.b Lenkschloss „lock“

Um die Lenkung zu sperren, gehen Sie wie folgt vor:

- Lenker ganz nach links drehen
- Stecken Sie den Schlüssel (1) im Zündschloss (2) in Position .
- Drücken Sie den Schlüssel (1) und drehen Sie ihn gegen den Uhrzeigersinn in die Position „lock“.
- Den Schlüssel entfernen.





Zum Entriegeln der Lenkung den Rückwärtsgang einlegen.





2.7 LINKER STEUERBLOCK

Der linke Steuerblock hat die folgenden Befehle:

1.  Lichthupe.
2.  Abblendlicht-/Fernlichtschalter.
3.  Warnblinkanlage.
4.  Hupe.
5.  Fahrtrichtungsanzeiger.



Lichthupe „“

Bei eingeschaltetem Abblendlicht die Taste (1) drücken.





Abblend-/Fernlichtschalter „ / “

Je nach Stellung des Schalters (2) leuchten Abblend- oder Fernlicht:

-  Leuchtende Abblendlichter.
-  Leuchtende Fernlichter.

Warnblinkanlage „“



Durch Drücken des Schalters (3) blinken alle Fahrtrichtungsanzeiger gleichzeitig und die Leuchten „“ und „“ blinken auf der Instrumententafel.

HINWEIS: Verwenden Sie die Warnblinkanlage nur bei Bedarf, um andere Fahrzeuge vor dem Stillstand Ihres Motorrads zu warnen. Die Verwendung der Warnblinkanlage bei ausgeschaltetem Motor kann die Batterien entladen.

Hupe „“

Drücken Sie die Taste (4), um die Hupe zu aktivieren.

Blinkerschalter „“

Durch schieben des Schalters (5) in Richtung „“ si inserisce l'indicatore di direzione wird der linke Fahrtrichtungsanzeiger aktiviert, durch Verschieben des Schalters (5) in Richtung „“ wird der rechte Fahrtrichtungsanzeiger aktiviert: Nach dem Loslassen kehrt der Schalter in die Mittelstellung zurück. Um den eingesetzten Fahrtrichtungsanzeiger auszuschalten, drücken Sie den Schalter, sobald er sich in der Mittelstellung befindet.



2.8 RECHTER STEUERBLOCK

Der rechte Steuerblock hat die folgenden Befehle:

1. ☒ Notausschalter/
Motorstoppschalter.
2. ↻ Motorstartknopf.



2.8.a Notausschalter zum Abstellen des Motors

ACHTUNG

Drücken Sie den Notausschalter (1), um den Motor nur in einem echten Notfall auszuschalten.

Wenn er in der Position „☒“ gedrückt wird, deaktiviert er das Starten und den Betrieb des Motors.

Wenn er in der Position „↻“ gedrückt wird, startet er den Motor.

2.8.b Motorstartknopf

Durch Drücken des Motorstartknopfes (2) mit dem Schlüssel in der Position „↻“ und dem Schalter (1) in der Position „☒“, und Ziehen des Bremshebels startet der Motor.

2.9 GASDREHGRIFF

Der Gasdrehgriff (1) befindet sich auf der rechten Seite des Lenkers.





2.10 BEDIENUNG DER VORDERRADBREMSE

Der Bremshebel (1) befindet sich auf der rechten Seite des Lenkers. Ein Stoppschalter bewirkt beim Bremsen das Aufleuchten der Rücklichtleuchte. Um die Bremse zu betätigen, ziehen Sie den Hebel in Richtung Gasgriff. Die Position des Bedienelements am Lenker kann durch Lösen der beiden Befestigungsschrauben (2) eingestellt werden.

WARNUNG

Vergessen Sie nicht, die Schrauben (2) nach der Einstellung festzuziehen.

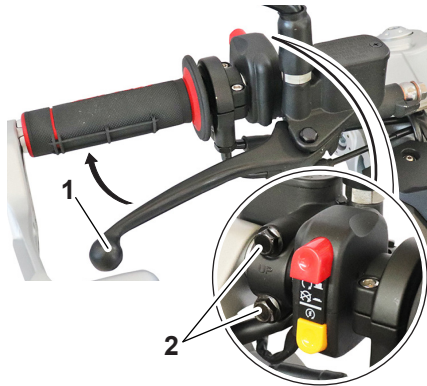

2.11 BEDIENUNG DER HINTERRADBREMSE

Der Bremshebel (1) befindet sich auf der linken Seite des Lenkers. Ein Stoppschalter bewirkt beim Bremsen das Aufleuchten der Rücklichtleuchte. Um die Bremse zu aktivieren, ziehen Sie den Hebel in Richtung des Griffs. Die Position des Bedienelements am Lenker kann durch Lösen der beiden Befestigungsschrauben (2) eingestellt werden.



WARNUNG

Vergessen Sie nicht, die Schrauben (2) nach der Einstellung festzuziehen.





2.12 KRAFTSTOFFTANK

GEFAHR

Benzin ist hochentzündlich und kann unter bestimmten Bedingungen explosiv werden. Stellen Sie immer den Motor ab, rauchen Sie nicht und halten Flammen oder Funken von dem Bereich fern, in dem Sie Kraftstoff tanken oder lagern.

2.12.a Tanken

- Motor abstellen.
- Heben Sie die Schlossabdeckung (1) an.
- Den Schlüssel (2) einstecken und ¼-Umdrehung in Pfeilrichtung „A“ drehen, um die Kappe (3) zu entfernen.
- Füllen Sie den Kraftstoff in den Tank.

WARNUNG

Füllen Sie den Tank nicht über die untere Grenze des Einfüllstutzens hinaus. Wenn der Kraftstoff überläuft, reinigen Sie den Kraftstoff sofort mit einem Lappen, da er nicht nur hochentzündlich ist, sondern auch Lack- oder Kunststoffoberflächen angreifen kann.

- Die Kappe (3) in wieder anbringen, den Schlüssel in Pfeilrichtung „B“ drehen, dann den Schlüssel (2) abziehen und die Schlossschutzabdeckung (1) absenken.

HINWEIS: Das Aufsetzen des Tankdeckels (3) ist nicht möglich, wenn der Schlüssel nicht im Schloss steckt; es ist nur möglich, den Schlüssel (2) aus der Kappe (3) zu ziehen, wenn diese richtig geschlossen ist.

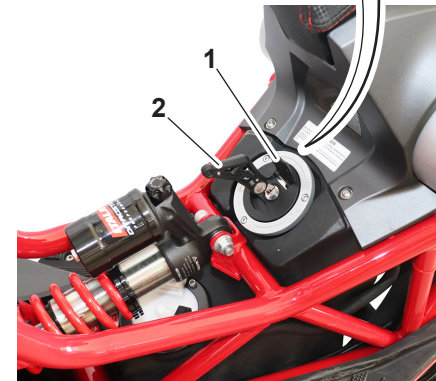
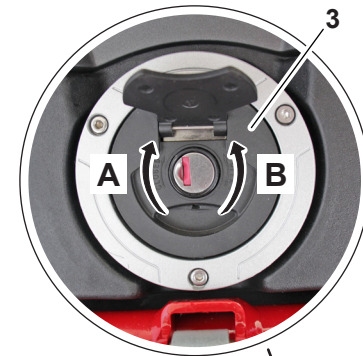



⚠️ WARNUNG

Prüfen Sie nach dem Tanken, ob der Tankdeckel richtig geschlossen ist. Kraftstofflecks stellen eine Brandgefahr dar.

2.13 KRAFTSTOFF

⚠️ WARNUNG

Benzin ist giftig und kann zu Verletzungen oder zum Tod führen. Gehen Sie vorsichtig mit Benzin um. Saugen Sie Benzin niemals mit dem Mund auf. Bei Verschlucken von Benzin, Einatmen großer Mengen Benzindämpfe oder Kontakt mit den Augen sofort einen Arzt aufsuchen. Wenn Sie Benzin auf Ihre Haut verschütten, waschen Sie es mit Wasser und Seife

ab. Wenn Sie Benzin auf Ihre Kleidung verschütten, wechseln Sie diese.

Der Motor wurde für die Verwendung von bleifreiem Benzin mit einer kontrollierten Oktanzahl von 95 oder höher entwickelt. Wenn der Motor klopft, verwenden Sie eine andere Marke oder Benzin mit höherer Oktanzahl.

Empfohlener Kraftstoff:
Bleifreies Benzin
(E10 akzeptabel)

Oktanzahl (RON):
95

E5

E10

HINWEIS:

- Diese Referenz gibt den empfohlenen Kraftstoff für dieses Fahrzeug gemäß der europäischen Verordnung (EN228) an.
- Stellen Sie sicher, dass die Zapfpistole der Kraftstoffpumpe dieselbe Kraftstoffidentifikationsnummer hat.

2.13.a Verschiedene Arten von Benzin

Es gibt verschiedene Benzinsorten, die Ethanol enthalten. Ethanolhaltiges Benzin kann verwendet werden, wenn der Ethanolgehalt 10% (E10) nicht überschreitet. **Italjet** empfiehlt kein Benzin, das Methanol enthält, da es das Kraftstoffsystem beschädigen oder zu Leistungsproblemen des Fahrzeugs führen kann.

ACHTUNG

Verwenden Sie nur bleifreies Benzin. Die Verwendung von verbleitem Benzin würde sowohl die inneren Teile des Motors, wie Ventile und Segmente, als auch die Abgasanlage ernsthaft beschädigen.



2.13.b Katalysator

Das Abgassystem umfasst Katalysatoren, um schädliche Abgasemissionen zu reduzieren.

⚠️ WARNUNG

Die Auspuffanlage erreicht beim Betrieb des Fahrzeugs hohe Temperaturen. Um Brand- oder Verbrennungsgefahr zu vermeiden:

- Parken Sie das Fahrzeug nicht in der Nähe von Materialien, die eine Brandgefahr darstellen können, wie trockenes Gras oder andere leicht brennbare Materialien.
- Parken Sie das Fahrzeug an einem Ort, an dem keine Gefahr für Fußgänger oder Kinder besteht, die heiße Auspuffanlage zu berühren.

- Prüfen Sie, ob die Abgasanlage abgekühlt ist, bevor Sie Wartungsarbeiten daran durchführen.
- Lassen Sie den Motor nicht mehrere Minuten lang im Leerlauf laufen. Ein längerer Leerlauf kann zu Hitze- und Stau führen.

2.14 ZUBEHÖRTEILE UND USB-BUCHSE

ACHTUNG

Das an die USB-Buchse angeschlossene Zubehör darf nicht bei ausgeschaltetem Motor verwendet werden und die Last darf 12W (1A) nicht überschreiten, da sonst die Sicherungen durchbrennen können und die Batterie entladen werden kann.

2.14.a Verwenden der USB-Buchse

- Heben Sie den Schutz (1) an.
- Schließen Sie das Zubehör an die Steckdose (2) an.
- Wenn die Steckdose nicht mehr verwendet wird, den Schutz wieder richtig positionieren.

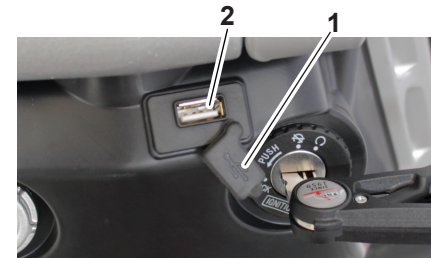



2.14.b Staufach unter dem Sattel

- Stellen Sie das Fahrzeug auf den Seitenständer oder Hauptständer.
- Stecken Sie den Schlüssel (1) in das Schloss (2) und drehen Sie ihn, bis das Sitzschloss entriegelt ist.
- Heben Sie den Sattel (3) an, um Zugang zum Fach (4) zu erhalten.
- Um den Sattel zu schließen, senken Sie ihn ab und drücken Sie ihn nach unten, bis er in das Schloss einrastet.

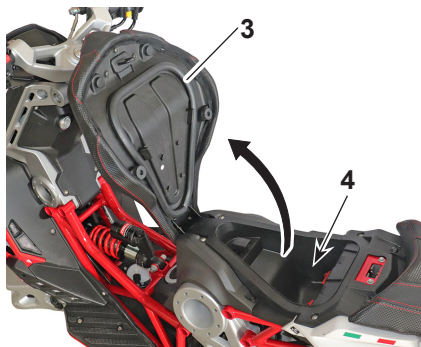
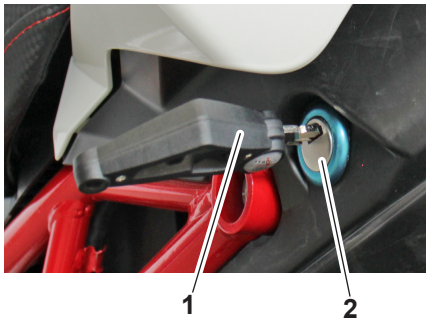

HINWEIS: Nach dem Öffnen des Fachs unter dem Sattel ist es möglich, den Schlüssel aus dem Schloss zu ziehen.





2.14.c Seitenständer

ACHTUNG

Der Ständer ist so konstruiert, dass er NUR das GEWICHT DES MOTORRADS trägt. Setzen Sie sich nicht auf das Fahrzeug und verwenden Sie den Ständer nicht als Stütze; Ein Bruch des Seitenständers kann zu schweren Verletzungen führen.

ACHTUNG

Das Fahrzeug MUSS NUR auf den Seitenständer gestellt werden, nachdem der Fahrer das Fahrzeug verlassen hat.

ACHTUNG

Am Motorrad ist ein Sicherheits-sensor angebracht, der ein Starten des Motorrads bei ausgeklapptem Ständer nicht zulässt. Wenn der Ständer bei laufendem Motorrad abgesenkt wird, stoppt der Motor.

Der Seitenständer befindet sich auf der linken Seite des Rahmens. Heben oder senken Sie den Seitenständer (1) mit dem Fuß, während Sie das Fahrzeug aufrecht halten.

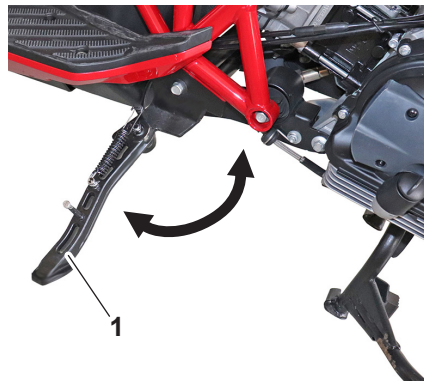

! ACHTUNG

Verwenden Sie das Fahrzeug nicht mit heruntergeklapptem Seitenständer.

Wenn der Seitenständer nicht angehoben bleibt, muss der nächste *Italjet*-Händler zur Reparatur kontaktiert werden.

Überprüfen Sie regelmäßig die korrekte Funktion des Seitenständers und die korrekte Funktion des Sicherheits-sensors, der das Starten des Fahrzeugs bei heruntergeklapptem Ständer blockiert.



2.14.d Hauptständer

- Greifen Sie den linken Lenkergriff (1) und den linken Beifahrergriff (2).
- Drücken Sie mit dem rechten Fuß auf den Hebel (3) des Hauptständers (4) und heben Sie gleichzeitig das Fahrzeug nach oben und hinten an, bis es vollständig auf dem Hauptständer steht.

ACHTUNG

Wenn das Fahrzeug auf dem Hauptständer abgestellt ist, ist es gefährlich, sich an Bord zu setzen und das Gewicht auf die Abstellstütze zu legen.

Um das Motorrad vom Hauptständer abzusenken, gehen Sie wie nachfolgend beschrieben vor.

- Greifen Sie den linken Griff (1) und den linken Griff (2) des Beifahrers.
- Stellen Sie Ihren Fuß vor den Ständer und schieben Sie das Motorrad nach vorne, bis es sich vom Ständer löst; der Ständer wird automatisch angeklappt.





3.1 ÜBERPRÜFUNGEN VOR DER VERWENDUNG

Überprüfen Sie das Fahrzeug bei jeder Benutzung, um sicherzustellen, dass es sich in einem betriebssicheren Zustand befindet. Beachten Sie immer die im Betriebs- und Wartungshandbuch beschriebenen Inspektions- und Wartungsverfahren und -intervalle.

WARNUNG

Wenn das Fahrzeug nicht ordnungsgemäß überprüft oder gewartet wird, erhöht sich die Wahrscheinlichkeit von Unfällen oder Schäden am Fahrzeug. Verwenden Sie das Fahrzeug nicht, wenn Probleme auftreten. Wenn die Störung mit den Anweisungen in diesem Handbuch nicht behoben werden kann, lassen Sie das Fahrzeug von einem *Italjet*-Händler überprüfen.

Bevor Sie dieses Fahrzeug benutzen, überprüfen Sie bitte die folgenden Punkte:

ELEMENT	ÜBERPRÜFUNGSARBEITEN
<i>Kraftstoff</i>	<ul style="list-style-type: none"> - Prüfen Sie den Kraftstoffstand im Kraftstofftank. - Bei Bedarf tanken. - Auf Undichtigkeiten im Kraftstoffkreislauf prüfen.
<i>Motoröl</i>	<ul style="list-style-type: none"> - Ölstand im Motor prüfen. - Bei Bedarf Öl der empfohlenen Sorte bis zum Füllstand nachfüllen. - Kontrollieren Sie, ob der Motor Öllecks aufweist.
<i>Getriebeöl</i>	<ul style="list-style-type: none"> - Kontrollieren Sie, ob das Getriebe Öllecks aufweist.
<i>Kühlmittel</i>	<ul style="list-style-type: none"> - Kühlmittelstand im Ausgleichsbehälter prüfen. - Füllen Sie ggf. Kühlmittel nach. - Kontrollieren Sie, ob das Kühlsystem Undichtigkeiten aufweist.
<i>Räder und Bereifung</i>	<ul style="list-style-type: none"> - Auf Beschädigungen prüfen. - Zustand der Reifen und Profiltiefe prüfen. - Überprüfen Sie den Luftdruck.



ELEMENT	ÜBERPRÜFUNGSARBEITEN
Bremsen	<ul style="list-style-type: none">- Überprüfen Sie die Funktion der Bremsen.- Wenn Sie ein Gefühl von Weichheit und Geschmeidigkeit haben, lassen Sie das Bremssystem von einem Italjet-Händler überprüfen.- Prüfen Sie den Verschleiß der Bremsbeläge.- Ersetzen Sie sie bei Bedarf (für einen Austausch wenden Sie sich an einen Italjet-Händler).- Flüssigkeitsstand im Bremsbehälter prüfen, ggf. nachfüllen (zum Nachfüllen wenden Sie sich an einen Italjet-Händler).- Kontrollieren Sie, ob das Hydrauliksystem Undichtigkeiten aufweist.
Seitenständer, Mittelständer	<ul style="list-style-type: none">- Stellen Sie sicher, dass die Bewegungsmechanismen geschmeidig sind.- Schmieren Sie bei Bedarf die Drehpunkte.
Instrumente, Lichter, Signale und Schalter	<ul style="list-style-type: none">- Überprüfen Sie die Funktion der Lichter und Fahrtrichtungsanzeiger.
Seitenständerschalter	<ul style="list-style-type: none">- Funktion des Zündkreisunterbrechungssystems prüfen.- Wenn das System nicht richtig funktioniert, lassen Sie das Fahrzeug von einem Italjet-Händler überprüfen.



3.2 GEBRAUCHSANWEISUNG DES FAHRZEUGS

HINWEIS: Wenn Sie mit der Bedienung des Fahrzeugs nicht vertraut sind, lesen Sie vor der Fahrt die Anweisungen im Abschnitt „BEDIENELEMENTE“ sorgfältig durch.

3.2.a Einfahrhinweise

Während der ersten 1000 km müssen folgende Regeln GENAU eingehalten werden, deren NICHTEINHALTUNG ÜBER LEBENS- UND LEISTUNGSFÄHIGKEIT DES MOTORRADS ENTSCHEIDEN KANN:

- Vor dem Gebrauch des Fahrzeugs den Motor auf einer niedrigen Drehzahl warmlaufen lassen;
- Vermeiden Sie schnelle Starts und lassen Sie den Motor nicht mit hohen Drehzahlen laufen;
- Fahren Sie mit mäßiger Geschwindigkeit, bis der Motor warmgelaufen ist;
- Verwenden Sie wiederholt beide Bremsen, um die Beläge und Scheiben einzufahren;

- Vermeiden Sie es, die gleiche Geschwindigkeit über längere Zeit beizubehalten;
- Vermeiden Sie lange Fahrten ohne Zwischenstopps.

3.2.b Identifizierung von Betriebsstörungen

Die nachfolgende Auflistung eventueller Betriebsstörungen dient generell dazu, deren Ursache zu erkennen und Abhilfe zu schaffen.

Der Motor startet nicht

- Unzureichende Starttechnik: Folgen Sie den Anweisungen im Abschnitt "Starten des Motors";
- Seitenständer ausgeklappt.

Der Motor startet langsam slow

- Verschmutzte Zündkerze oder in schlechtem Zustand: ersetzen

Der Motor startet, aber der Betrieb ist ungleichmäßig

- Zündkerze verschmutzt oder in schlechtem Zustand: ersetzen;

Die Kerze wird leicht schmutzig

- Unzureichende Zündkerze: ersetzen

Dem Motor fehlt die Leistung

- Verschmutzter Luftfilter: säubern;

Die Bremsen funktionieren nicht richtig

- Abgenutzte Beläge: in einer Fachwerkstatt ersetzen lassen.

ACHTUNG

Bei allen anderen Problemen wenden Sie sich an einen *Italjet*-Händler.



3.3 AUFSTEIGEN/ABSTEIGEN VON FAHRER UND BEIFAHRER

3.3.a Allgemeine Regeln

Lesen Sie die folgenden Anweisungen sorgfältig durch, da sie wichtige Informationen für die Sicherheit von Fahrer und Beifahrer enthalten, um Verletzungen von Personen oder Schäden am Fahrzeug zu vermeiden.

Das Auf- und Absteigen muss immer von der linken Seite des Fahrzeugs erfolgen, mit freien Händen, ungehindert und mit angehobenem Mittelständer. Wenn ein Seitenständer vorhanden ist, kann der Fahrer auch mit nach unten geklapptem Seitenständer aufsteigen.

Der Fahrer muss als erster auf das Fahrzeug steigen und als letzter absteigen. Dabei muss er die Stabilität des Fahrzeugs während des Auf- und Abstiegs des Beifahrers kontrollieren. Steigen Sie nicht von dem Fahrzeug ab, indem Sie springen oder Ihr Bein ausstrecken, sondern führen Sie immer die im entsprechenden Abschnitt beschriebenen Vorgänge aus.

3.3.b Aufstieg des Fahrers

Heben Sie den Mittelständer an. Wenn ein Seitenständer vorhanden ist, lassen Sie ihn in der abgesenkten Position.

- Halten Sie den Lenker von der linken Seite mit beiden Händen fest, heben Sie dann das rechte Bein an und passieren Sie den Sattel.
- Setzen Sie sich auf das Motorrad und stellen Sie beide Füße auf den Boden, um das Fahrzeug gerade zu stellen, ohne Ihr Gewicht auf den Seitenständer (falls vorhanden) zu verlagern.

! WARNUNG

Wenn Sie nicht mit beiden Füßen auf dem Boden stehen können, dann stabilisieren Sie mit Ihrem rechten oder linken Fuß das Fahrzeug.

- Mit dem linken Fuß den Seitenständer (falls vorhanden) vollständig einfahren;
- Starten Sie das Fahrzeug wie im entsprechenden Absatz beschrieben.

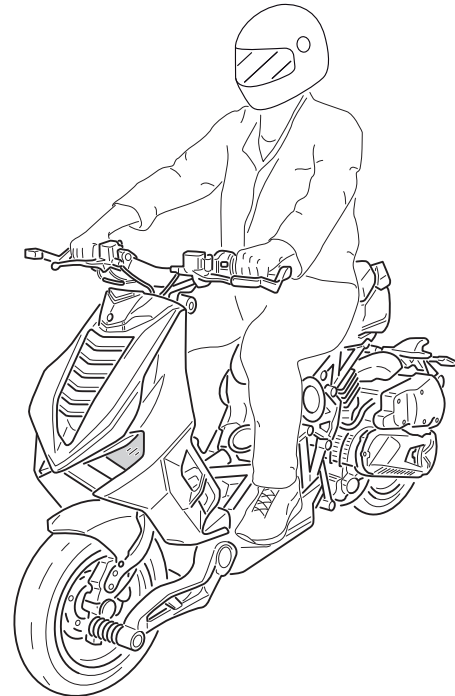



3.3.c Aufstieg des Beifahrers

- Der Fahrer muss wie im entsprechenden Absatz beschrieben auf das Motorrad steigen, ohne das Motorrad zu starten.
- Der Beifahrer muss die Fußrasten (1) herausziehen.

⚠️ WARNUNG

Der Fahrer in Fahrposition darf die hinteren Beifahrerfußrasten auf keinen Fall ausziehen oder versuchen, diese auszufahren, da dies die Balance des Fahrzeugs beeinträchtigen könnte.

- Steigen Sie auf das Fahrzeug, indem Sie Ihr rechtes Bein anheben und vorsichtig bewegen, um das Fahrzeug und den Fahrer nicht aus dem Gleichgewicht zu bringen.

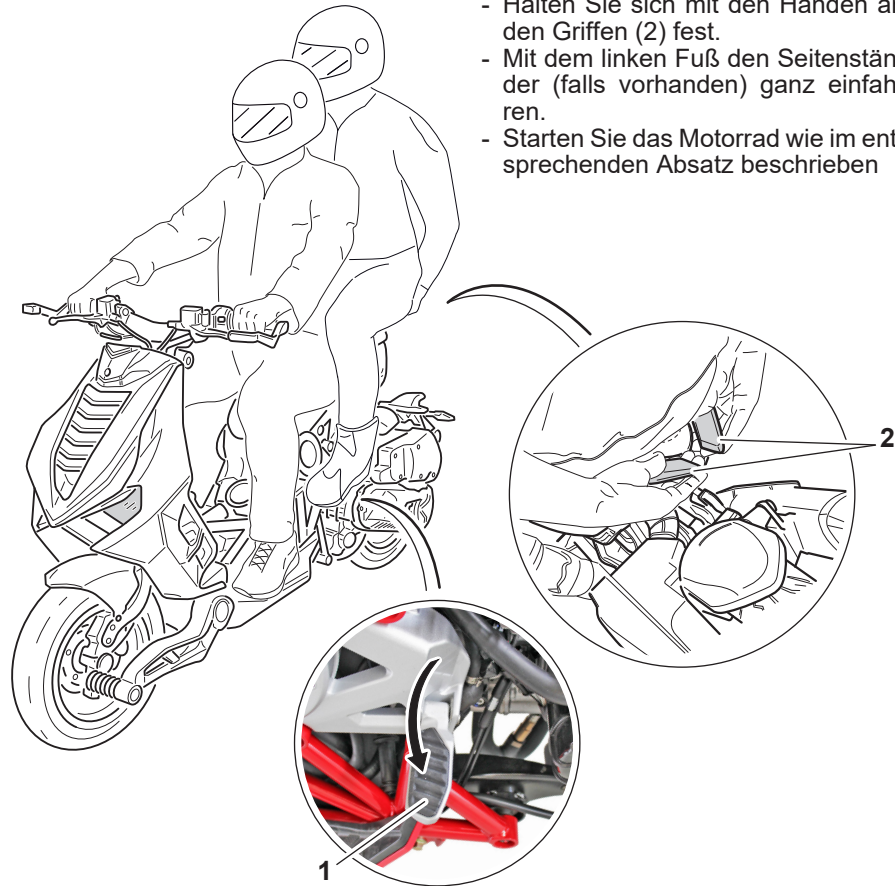

- Halten Sie sich mit den Händen an den Griffen (2) fest.
- Mit dem linken Fuß den Seitenständer (falls vorhanden) ganz einfahren.
- Starten Sie das Motorrad wie im entsprechenden Absatz beschrieben





3.3.d Abstieg vom Fahrzeug

- Halten Sie das Fahrzeug an und stellen Sie den Motor ab.

! WARNUNG

Stellen Sie sicher, dass der Untergrund, auf dem das Fahrzeug abgestellt werden soll, stabil und eben ist.

- Stellen Sie beide Füße auf den Boden.
- Stellen Sie das Fahrzeug wie im entsprechenden Absatz beschrieben ab.
- Ziehen Sie den Seitenständer (falls vorhanden) mit dem linken Fuß vollständig heraus.
- Der Beifahrer muss die linke Seite des Fahrzeugs verlassen, indem er sein rechtes Bein anhebt.
- Motorrad nach links kippen, bis es auf dem Seitenständer, falls vorhanden, aufliegt.
- Steigen Sie, mit den Händen fest am Lenker, auf der linken Seite vom Fahrzeug ab, indem Sie das rechte Bein anheben.

3.4 EINSTELLUNG DER RÜCKSPIEGEL

Setzen Sie sich wie im entsprechenden Absatz beschrieben auf das Motorrad.

Stellen Sie beide Spiegel (1) durch direktes Justieren so ein, dass der Fahrer aus sitzender Position die Straße hinter ihm korrekt sieht.









4.1 STARTEN DES FAHRZEUGS

Nach dem Aufsteigen auf das Fahrzeug, wie im entsprechenden Absatz angegeben, zum Anlassen des Motors wie folgt vorgehen:

HINWEIS: Das Motorrad startet nicht, wenn der Seitenständer heruntergeklappt ist.

- Den Schlüssel (1) des Zündschlosses in Stellung „“ bringen.



- Die Kontrollleuchte „“ leuchtet für einige Sekunden auf und erlischt dann, während die Leuchten „“, „“ bis zum Anlassen des Fahrzeugs an bleiben.

- Sich vergewissern, dass der Gaszug (2) vollständig gelöst ist und dass sich der seitliche Kippständer in Fahrtstellung befindet.
- Ziehen Sie an einem der beiden Bremshebel.
- Drücken Sie den Motorstartknopf (3) und lassen Sie ihn los, sobald der Motor anspringt.



HINWEIS: Die „ABS“-Warnleuchte bleibt an, bis das Fahrzeug eine Geschwindigkeit von 10km/h (6mi/h) erreicht, und erlischt dann.

HINWEIS: Den kalten Motor nicht mit hoher Drehzahl laufen lassen, damit sich das Öl erwärmt und an allen Stellen zirkulieren kann, die geschmiert werden müssen.





4.1.a Verwendung des Gasdrehgriffs

- Den gezogenen Bremshebel loslassen und gleichzeitig den Gasgriff (1) drehen; Die Geschwindigkeit ist direkt proportional zur Drehung des Gasgriffs; durch Drehen des Griffs in Richtung „A“ beschleunigt das Fahrzeug, durch Drehen des Griffs in Richtung „D“ verlangsamt sich das Fahrzeug.

4.1.b Verwendung der Bremsen

Um eine stärkere Bremswirkung zu erzielen, empfiehlt es sich, beide Bremsen gleichzeitig zu betätigen.

- Lassen Sie den Gasgriff (1) los und ziehen Sie beide Bremshebel (2), um den Druck schrittweise entsprechend dem gewünschten Bremsgrad zu erhöhen.

WARNUNG

Abruptes Bremsen vermeiden; beim Bremsen mit dem Fahrzeug an einer Steigung sehr vorsichtig sein – Absturzgefahr. Unter bestimmten Bedingungen kann die unabhängige Verwendung der Vorder- oder Hinterradbremse nützlich sein. Verwenden Sie die Vorderradbremse vorsichtig, insbesondere auf rutschigem Untergrund. Eine falsche Verwendung der Bremsen kann zu schweren Unfällen führen.







4.1.c Abstellen von Fahrzeug und Motor

- Lassen Sie den Gasdrehgriff (1) vollständig los, um das Fahrzeug zu verlangsamen.
- Betätigen Sie die Vorder- und Hinterbremse.
- Nach dem Anhalten des Fahrzeugs den Zündschlüssel (2) in Stellung „“ (Schlüsselabzugsstellung) drehen; der Motor stoppt.



4.1.d Abstellen des Motors im Notfall

- Um den Motor im Notfall abzustellen, drücken Sie den roten Schalter (1) auf „“; Nach dem Anhalten des Fahrzeugs den Schalter (1) wieder in die Position „“ bringen.

WARNUNG

Falls der Gasdrehgriff in der geöffneten Position blockiert oder eine andere Fehlfunktion verursacht wird, die dazu führt, dass der Motor unkontrolliert hochdreht, drücken Sie **SOFORT** den Motorstoppknopf (1). Behalten Sie die Kontrolle über das Motorrad bei normalem Gebrauch der Bremsen und der Lenkung, während Sie den Stoppknopf drücken.



4.1.e Abstellen des Fahrzeugs

Stellen Sie das Motorrad auf den Seitenständer oder auf den Hauptständer, wie in den entsprechenden Abschnitten beschrieben.

WARNUNG

- Nach dem Abstellen des Fahrzeugs können der Motor und die Auspuffanlage sehr heiß sein. Versuchen Sie so zu parken, dass Fußgänger diese Teile nicht versehentlich berühren.
- Parken Sie nicht neben trockenem Gras oder anderen brennbaren Materialien, die Feuer fangen können.
- Parken Sie nicht an Hängen oder auf weichem Untergrund; das Fahrzeug könnte umkippen mit möglichem Kraftstoffaustritt und Brandgefahr.



5.1 WARTUNG UND REGELMÄSSIGE KONTROLLEN

5.1.a Regelmäßige Wartung

Regelmäßige Inspektionen, Einstellungen und Schmierungen halten das Fahrzeug in den bestmöglichen Sicherheits- und Leistungsbedingungen. Auf den folgenden Seiten sind die wichtigsten Punkte zum Thema Fahrzeugkontrolle, Einstellung und Schmierung dargestellt.

Die in der Tabelle angegebenen Wartungsintervalle sind nur als allgemeine Richtlinie unter normalen Fahrbedingungen zu verstehen. Je nach klimatischen Bedingungen, Gelände, geografischer Lage und individueller Nutzung kann es jedoch erforderlich sein, die Wartungsintervalle zu verkürzen.

WARNUNG

Mangelnde oder falsche Wartung des Fahrzeugs kann das Verletzungs- oder Todesrisiko bei der Benutzung des Fahrzeugs erhöhen. Lassen Sie die Wartung von einem *Italjet*-Händler oder einer professionellen Reparaturwerkstatt durchführen.

WARNUNG

Vergewissern Sie sich vor der Durchführung von Wartungsarbeiten, dass Sie über die erforderlichen Werkzeuge, Komponenten und technischen Fähigkeiten verfügen.



- Stellen Sie den Motor ab und stellen Sie das Motorrad auf einer ebenen und festen Fläche ab.
- Warten Sie, bis Motor, Schalldämpfer und Bremscheiben abgekühlt sind.

WARNUNG

Wenn Sie das Fahrzeug auf staubigen, schlammigen oder sehr nassen Straßen einsetzen, ist es erforderlich, den Luftfilter mit einem kürzeren Wartungsintervall zu reinigen/ersetzen. Wenden Sie sich an Ihren *Italjet*-Händler, um das richtige Wartungsintervall zu erfahren.



Wartungsintervall Element	<i>Zeit oder Kilometerstand</i>											
	nach Zeit (Monate)	6	12	18	24	30	36	42	48	54	60	66
	nach Kilometerstand (km x 1000)	1	6	12	18	24	30	36	42	48	54	60
Motor												
Angetriebene Riemenscheibe Rolle			L		L		L		L		L	
Variatordeckel Kunststoffbuchse			R		R		R		R		R	
Kupplungsglocke		C	C	C	C	C	C	C	C	C	C	C
Antriebsriemen			R		R		R		R		R	
Getriebe Luftfilter			I		I		I		I		I	
Motoröl-Sieb-Vorfilter	C	C	C	C	C	C	C	C	C	C	C	C
Motorölfilter	R	R	R	R	R	R	R	R	R	R	R	R
Ventilspiel			A		A		A		A		A	
Nabenöl	R		R		R		R		R		R	
Motoröl (*)	R	R	R	R	R	R	R	R	R	R	R	R
CVT-Rollen			R		R		R		R		R	
Vorne beweglicher halber Riemenscheibenvariator			I		I		I		I		I	
Übersetzung			L		L		L		L		L	
Zündkerze			R		R		R		R		R	
Luftfilter		C	C	C	C	C	C	C	C	C	C	C



Wartungsintervall Element	<i>Zeit oder Kilometerstand</i>											
	nach Zeit (Monate)	6	12	18	24	30	36	42	48	54	60	66
	nach Kilometerstand (km x 1000)	1	6	12	18	24	30	36	42	48	54	60
Verdampfungssystem												
Behälter und Rohre												
Kühlsystem												
Kühlmittelstand (**)												
Kühler			C		C		C		C		C	
Kraftstoffsystem												
Kraftstofffilter			R		R		R		R		R	
Kraftstoffleitungen (***)												
Elektrisches System												
Batteriespannung												
Scheinwerfereinstellung			A		A		A		A		A	
Straßentest des Fahrzeugs												
Straßentest des Fahrzeugs												



Wartungsintervall Element	Zeit oder Kilometerstand											
	nach Zeit (Monate)	6	12	18	24	30	36	42	48	54	60	66
	nach Kilometerstand (km x 1000)	1	6	12	18	24	30	36	42	48	54	60
Chassis												
Sicherheitsbefestigungen												
Bremsen												
Bremsflüssigkeit (**)												
Aufhängungen												
Räder/Reifen												
Lenkung												
Abgassystem												
Drosselklappensteuerung	A		A		A		A		A		A	

I: Prüfen und reinigen, einstellen, fetten oder ggf. ersetzen

C: Reinigen

R: Ersetzen

A: Anpassen

L: Schmieren

(*) Überprüfen Sie den Füllstand alle 3000 km

(**) Alle 2 Jahre ersetzen

(***) Alle 4 Jahre ersetzen



5.1.b Ölstandskontrolle

HINWEIS: Die Prüfung muss bei ausgeschaltetem und noch warmen Motor durchgeführt werden.

! WARNUNG

Der Fahrzeugschalldämpfer erreicht hohe Temperaturen; achten Sie darauf, sich nicht zu verbrennen.

- Stellen Sie das Fahrzeug auf einer ebenen Fläche in senkrechter Position auf dem Mittelständer ab.
- Warten Sie einige Minuten, damit sich das Öl absetzen kann.
- Ölmesstab (1) abschrauben und herausnehmen, Messstab mit einem sauberen Lappen reinigen und wieder in die Einfüllöffnung (2) einführen, ohne ihn einzuschrauben, dann herausnehmen und prüfen, ob der Ölstand zwischen den Markierungen "MIN" und "MAX" liegt.
- Beim Nachfüllen Öl durch die Öffnung (2) bis zum MAX-Füllstand einfüllen und nicht darüber hinaus.
- Den Ölmesstab (1) wieder einschrauben.

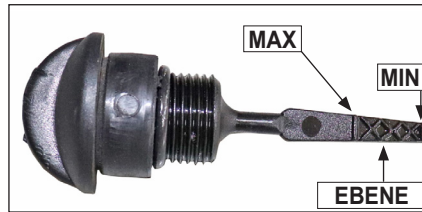

5.1.c Motoröl- und Filterwechsel

HINWEIS: Der Ölwechsel muss bei ausgeschaltetem und noch warmem Motor durchgeführt werden.

! WARNUNG

Achten Sie darauf, sich nicht mit heißem Öl zu verbrennen.

- Stellen Sie das Motorrad auf einer ebenen Fläche in senkrechter Position auf dem Mittelständer ab.
- Ölmesstab (1) entfernen.

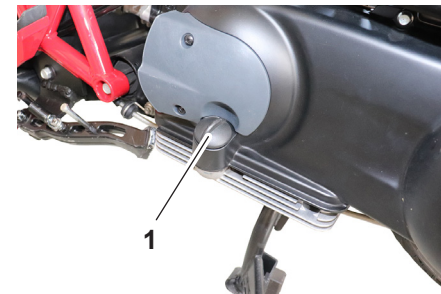



- Stellen Sie ein Auffangbecken unter mit die Ablassschraube (2).
- Ablassschraube (2) herausschrauben und das gesamte Öl ablaufen lassen.

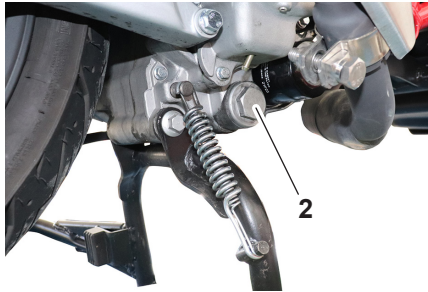

- Den Ölfilter (5) mit dem Filterwerkzeug (4) abschrauben.

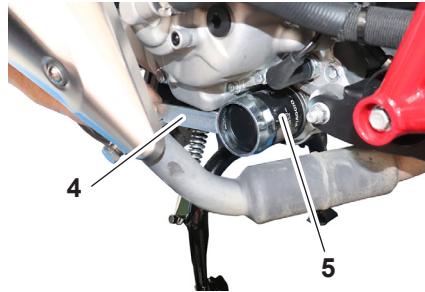

- Den Filter (3) reinigen, bei Beschädigung austauschen und wieder einsetzen.

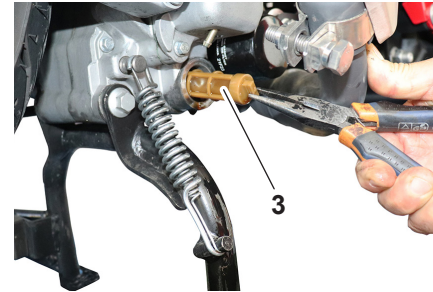

- Den auswaschbaren Filter (3) mit einer Zange entfernen.

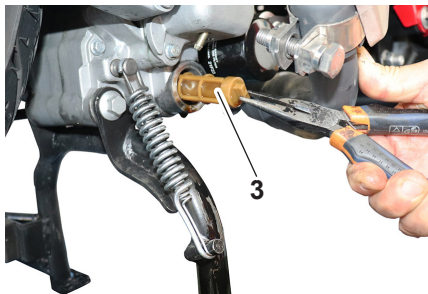

- Den Filter (5) entfernen.

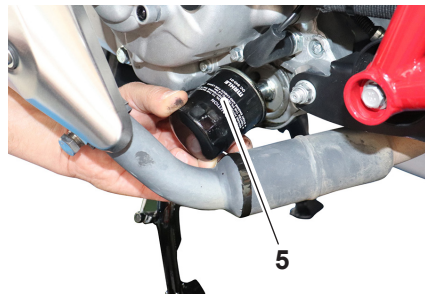

- Den Zustand der Dichtung (6) der Ölablassschraube (2) überprüfen, sollte sie beschädigt sein, diese austauschen.

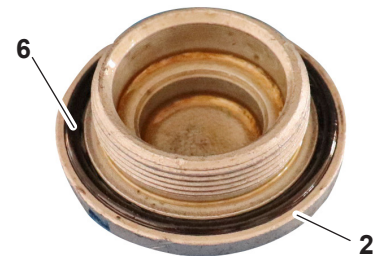



- Die Ablassschraube (2) mit einem Anzugsmoment von 25 Nm / 18,44 ft/lb wieder einbauen.

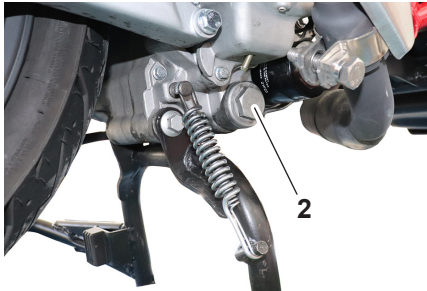

- Den Filter (5) durch Eindrehen mit dem Filterwerkzeug (4) mit einem Anzugsmoment von 12 Nm / 8,85 ft/lb montieren.

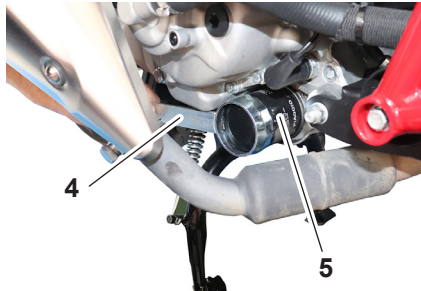

- Den Ölmesstab (1) durch Einschrauben wieder zusammenbauen.



HINWEIS: Für die zu verwendende Ölsorte siehe den Abschnitt „Auftanken“.

HINWEIS: Auf die Teile verschüttetes Öl mit einem Lappen reinigen, nachdem der Motor und die Auspuffanlage abgekühlt sind.

- Die Dichtung mit Öl schmieren (7).



- Ca. 1250 cm³ Öl durch die Einfüllöffnung (8) in den Ölbehälter einfüllen.

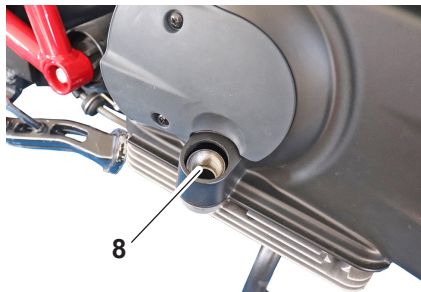

- Den Motor starten und einige Minuten im Leerlauf laufen lassen, dabei sicherstellen, dass kein Öl austritt. Stellen Sie bei einem Ölleck sofort den Motor ab und suchen Sie nach der Ursache.
- Motor abstellen, Ölstand prüfen und ggf. korrigieren.
- Setzen Sie das Wartungsintervall zurück, wie im Abschnitt "Digitalanzeige" beschrieben.





5.1.d Kühlmittelstandkontrolle

HINWEIS: Kühlmittelstand bei kaltem Motor prüfen.

- Stellen Sie das Motorrad auf einer ebenen Fläche in senkrechter Position auf dem Hauptständer ab.
- Deckel (1) des Ausdehnungsgefäßes (2) entfernen.

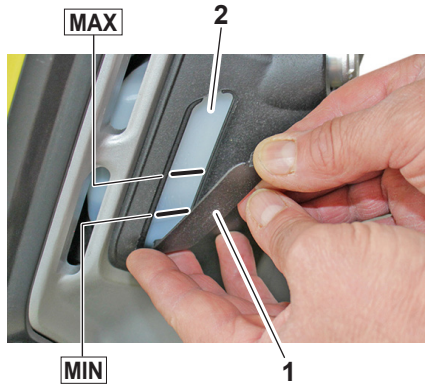

- Prüfen Sie, ob der Flüssigkeitsstand zwischen dem minimalen „MIN“-Niveau und dem maximalen „MAX“-Niveau des Tanks liegt.

- Falls nachgefüllt werden muss, den Tankdeckel (3) durch Abschrauben abnehmen und das Kühlmittel durch die Öffnung (4) einfüllen und den Füllstand am Tank (2) kontrollieren.
- Nach Wiederherstellung des Kühlmittelniveaus Kappe (3) und Abdeckung (1) wieder anbringen.

HINWEIS: Das Kühlmittel ist korrosiv; sollte beim Nachfüllen etwas verschüttet werden, die Teile, die mit Kühlmittel in Berührung gekommen sind, sorgfältig reinigen.

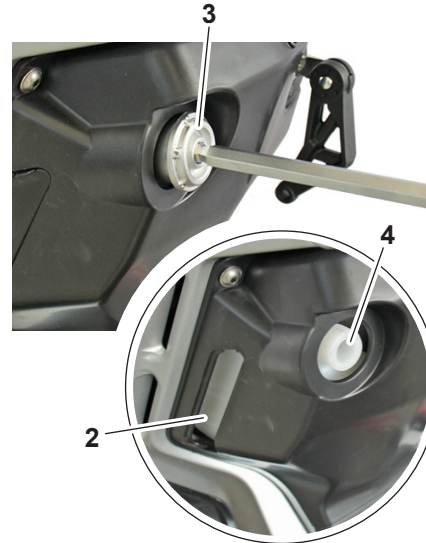

5.1.e Motorluftfilterreinigung

- Schrauben (1) lösen und Abdeckung (2) abnehmen.

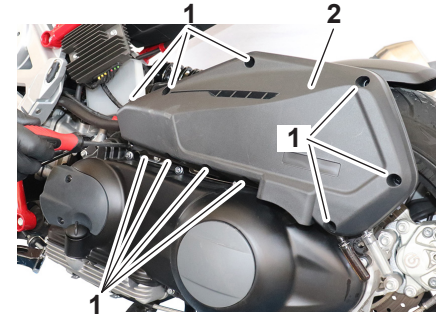

- Entfernen Sie den Filter (3) aus der Filterabdeckung (2).

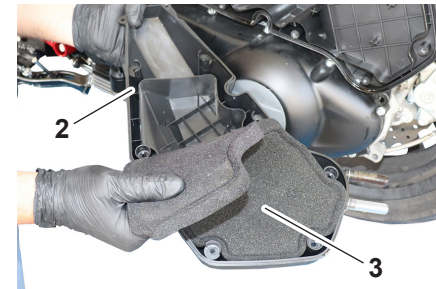



- Filter (3) mit geeignetem Filterreiniger reinigen und vollständig trocknen lassen.

⚠️ WARNUNG

Verwenden Sie zum Reinigen des Filters kein Benzin oder andere brennbare Lösungsmittel.

- Kontrollieren Sie, dass der Filter nicht abgenutzt oder beschädigt ist, ersetzen Sie ihn gegebenenfalls.
- Tragen Sie spezielles Öl für Filter auf die gesamte Oberfläche des Filters (3) auf und drücken Sie es dann aus, um überschüssiges Öl zu entfernen.
- Den Filter (3) auf dem Deckel (2) montieren.

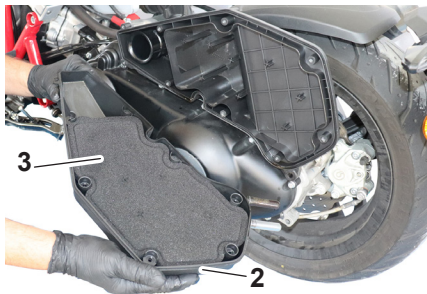

- Zustand der Dichtung (4) prüfen, bei Beschädigung ersetzen.

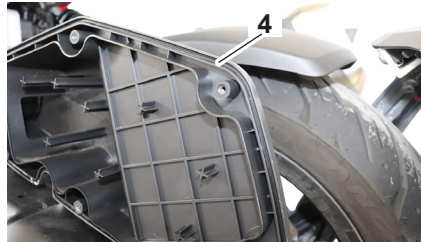

- Filterdeckel (2) durch Anziehen der Schrauben (1) wieder montieren.

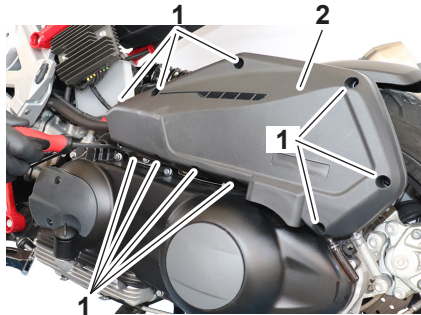

- Prüfen, ob die Entlüftungen (5) und (6) verschmutzt sind; in diesem Fall die Entlüftungen entfernen, reinigen und wieder einsetzen.





5.1.f Getriebeblutfilterreinigung

- Schrauben (1) lösen und Abdeckung (2) abnehmen.

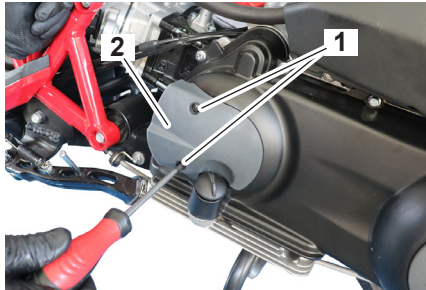

- Den Filter (3) herausnehmen und mit einem geeigneten Reinigungsmittel reinigen.

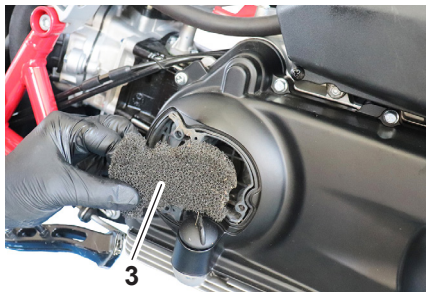

⚠ WARNUNG
Verwenden Sie zum Reinigen des Filters kein Benzin oder andere brennbare Lösungsmittel.

- Kontrollieren Sie, dass der Filter nicht abgenutzt oder beschädigt ist, ersetzen Sie ihn gegebenenfalls.
- Den Zustand der Dichtung (4) prüfen, bei Beschädigung ersetzen.

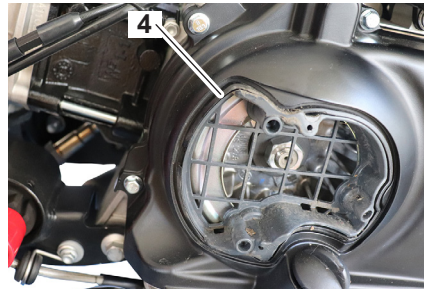

- Den Filter (3) und den Deckel (2) in umgekehrter Reihenfolge der Demontage wieder anbringen.

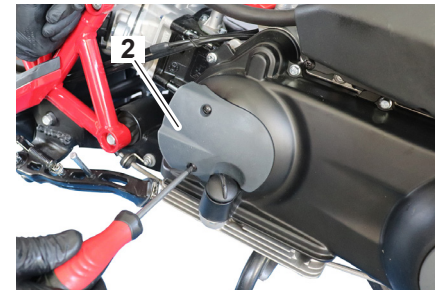



5.1.g Zündkerzenprüfung

⚠️ WARNUNG

Warten Sie, bis der Motor abgekühlt ist, bevor Sie die Prüfung durchführen; Verbrennungsgefahr.

- Entfernen Sie die Kappe (1).
- Entfernen Sie mit dem entsprechenden Schlüssel die Zündkerze (2).

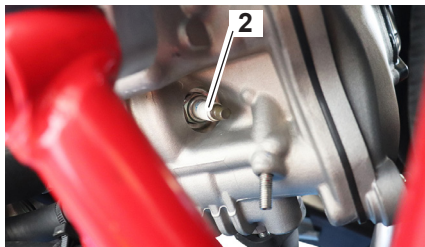

Der Abstand zwischen den Zündkerzenelektroden (2) muss $0,5 \div 0,6$ mm betragen.

Ein abweichender Abstand kann zu Fehlfunktionen des Fahrzeugs führen.

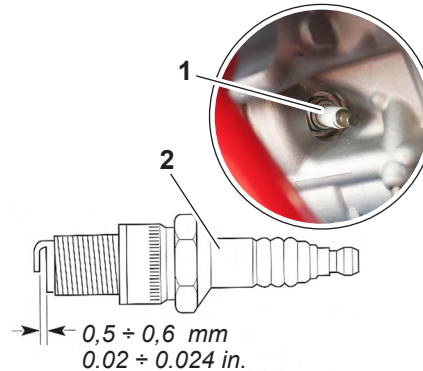

5.1.h Reifen- und Reifendruckprüfung

Es ist wichtig, Ihre Reifen immer in gutem Zustand zu halten und sie in den richtigen Intervallen durch Reifen gemäß der Spezifikation zu ersetzen. Kontrollieren Sie immer den Reifendruck und passen Sie ihn gegebenenfalls an, bevor Sie losfahren.

⚠️ WARNUNG

Die Verwendung des Fahrzeugs mit falschem Reifendruck kann zu schweren Verletzungen oder zum Tod durch Kontrollverlust führen.

- Reifendruck in kaltem Zustand prüfen und einstellen (d.h. wenn die Reifentemperatur der Umgebungstemperatur entspricht).
- Der Reifendruck muss entsprechend dem Gesamtgewicht von Fahrer, Beifahrer, Beladung und für dieses Modell zugelassenem Zubehör angepasst werden.



5.1.i Reifenkontrolle

Dieses Motorrad ist mit schlauchlosen Reifen ausgestattet.

- Überprüfen Sie den Zustand der Reifen; sie dürfen keine Risse, Abschürfungen usw. aufweisen; überprüfen Sie auch die Abnutzung der Lauffläche anhand der speziellen Indikatoren am Reifen selbst.

MINDESTPROFILTIEFE

VORDERSEITE	2 mm (0.08 in)
RÜCKSEITE	2 mm (0.08 in)

- Den Druck gemäß den Angaben im Abschnitt „Technische Daten“ prüfen.

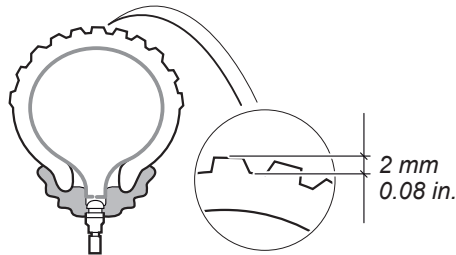

⚠️ WARNUNG

Die Vorder- und Hinterrreifen müssen vom gleichen Fabrikat und Modell sein, die Verwendung unterschiedlicher Reifentypen zwischen den Vorder- und Hinterrädern beeinträchtigt die Stabilität des Fahrzeugs und seine Manövrierfähigkeit.

HINWEIS: Reifen altern, auch wenn sie optisch nicht abgenutzt sind; seitliche Risse oder Verformungen sind ein Zeichen der Alterung. Lassen Sie die Reifen von einem Reifenhändler überprüfen, bevor Sie das Fahrzeug benutzen.

Reifendruck kalt:

1 Person:

Vorderseite:
190 kPa (1.9 Kgf/cm², 28 psi)

Rückseite:
200 kPa (2.00 kgf/cm², 29 psi)

2 Personen:

Vorderseite:
210 kPa (2.10 kgf/cm², 30 psi)

Rückseite:
250 kPa (2.50 kgf/cm², 36 psi)

- Um den Druck einzustellen, entfernen Sie die Kappe (1) und schließen Sie das Manometer an das Ventil (2) an.

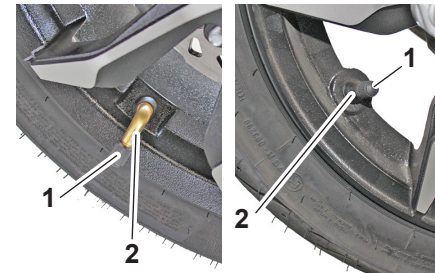



⚠️ WARNUNG

- Lassen Sie übermäßig abgenutzte Reifen durch einen Reifenhändler ersetzen. Die Verwendung des Fahrzeugs mit übermäßig abgefahrenen Reifen verringert die Fahrstabilität und kann zum Verlust der Kontrolle über das Fahrzeug führen.
- Fahren Sie nach dem Reifenwechsel mit mäßiger Geschwindigkeit, damit die Oberfläche des Reifens „sich einfahren“ kann, damit er seine Eigenschaften voll entfalten kann.

HINWEIS: Beim Reifenwechsel muss das Rad ausgewuchtet werden.

Kontrollieren Sie vor jedem Gebrauch die Felgen auf Risse, Knicke, Verformungen oder andere Beschädigungen. Bei Beschädigungen das Rad ersetzen lassen. Versuchen Sie nicht, auch nur die kleinste Reparatur an einem Rad vorzunehmen. Bei Verformungen oder Rissen muss das Rad ersetzt werden.

5.1.I Verschleiß der Bremsbeläge prüfen

Prüfen Sie den Verschleiß der vorderen Bremsbeläge (1) und der hinteren Bremsbeläge (2).

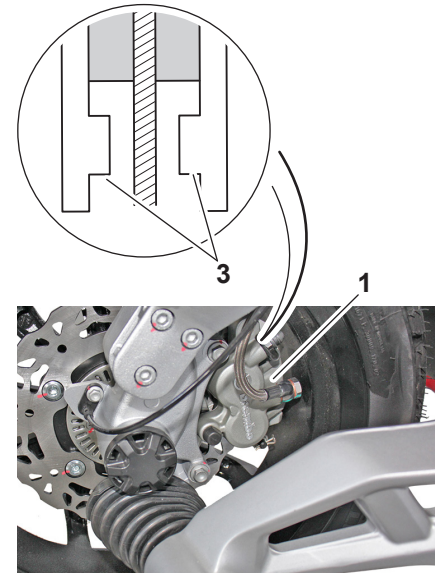



- Die Beläge sind mit einer Verschleißanzeige (3) ausgestattet. Zur Prüfung des Belagverschleißes die Stellung der Verschleißanzeige (3) beim Betätigen der Bremse prüfen. Wenn ein Belag so abgenutzt ist, dass die Verschleißanzeige fast die Bremsscheibe berührt, ersetzen Sie die Beläge paarweise.

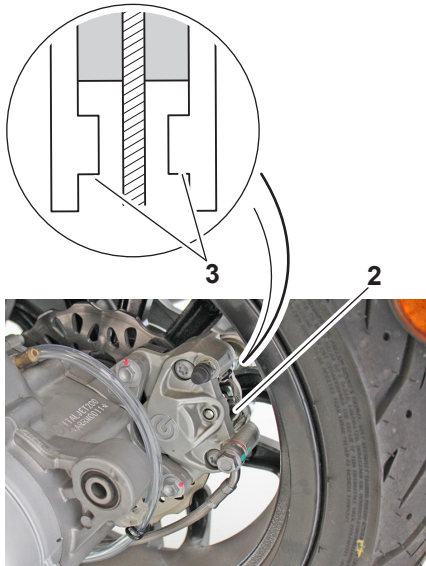

⚠ WARNUNG

Um die Bremsbeläge zu ersetzen, ist es notwendig, sich an einen *Italjet*-Händler zu wenden.

⚠ WARNUNG

Nach dem Austausch der Bremsbeläge ist es notwendig, vorsichtig zu fahren und schrittweise zu bremsen, damit sich die Beläge richtig setzen / mit den entsprechenden Scheiben koppeln.





5.1.m Bremsflüssigkeitsstand vorne/hinten prüfen

- Fahrzeug so positionieren, dass der obere Teil des Bremsflüssigkeitsbehälters parallel zum Boden ist.
- Der Flüssigkeitsstand im Pumpenbehälter muss sich in der Mitte der Felge (1) befinden

Jedes Absinken des Flüssigkeitsspiegels kann das Eindringen von Luft in das System ermöglichen, wodurch sich der Hub des Hebels verlängert. Wenn ein Auffüllen erforderlich ist, wenden Sie sich an Ihren **Italjet**-Händler.

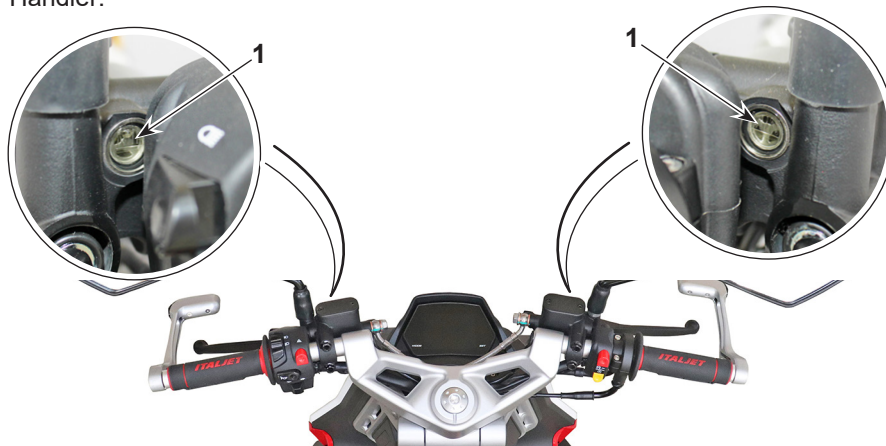

! WARNUNG

Ist der Bremshebel zu "weich", befindet sich Luft in der Leitung oder es liegt ein Systemdefekt vor. Da das Fahren des Fahrzeugs unter diesen Bedingungen gefährlich ist, lassen Sie das Bremssystem sofort von Ihrem **Italjet**-Händler überprüfen.

ACHTUNG

Keine Bremsflüssigkeit auf lackierte oder andere Oberflächen (z.B. Scheinwerfer) schütten.

! WARNUNG

Mischen Sie nicht zwei verschiedene Arten von Flüssigkeiten. Wenn Sie sich für die Verwendung einer anderen Flüssigkeitsmarke entscheiden, entleeren Sie die vorhandene vollständig.

! WARNUNG

Bremsflüssigkeit kann Reizungen verursachen. Kontakt mit Haut und Augen vermeiden. Bei Kontakt die betroffene Stelle vollständig reinigen und, wenn es zu Kontakt mit den Augen gekommen ist, einen Arzt aufsuchen.



WARNUNG

- Nur die gemäß Spezifikation vorgeschriebene Bremsflüssigkeit verwenden; Andernfalls können sich die Gummidichtungen verschlechtern und Leckagen verursachen.
- Füllen Sie Bremsflüssigkeit der gleichen Art nach. Die Zugabe einer anderen Bremsflüssigkeit als DOT 4 kann eine schädliche chemische Reaktion verursachen.
- Vermeiden Sie beim Befüllen das Eindringen von Wasser oder Staub in den Bremsflüssigkeitsbehälter. Wasser bewirkt eine deutliche Absenkung des Siedepunktes der Flüssigkeit und kann zu "Dampfsperren" führen und Schmutz kann die Ventile der ABS-Hydraulikeinheit verstopfen.

ACHTUNG

Bremsflüssigkeit kann lackierte Oberflächen oder Kunststoffteile beschädigen. Entfernen Sie verschüttete Flüssigkeit immer sofort.

Wenn die Bremsbeläge verschleifen, ist es normal, dass der Bremsflüssigkeitsstand allmählich sinkt. Bei niedrigem Bremsflüssigkeitsstand ist es möglich, dass die Bremsbeläge abgenutzt sind und/oder eine Undichtigkeit im Bremskreis vorliegt; Überprüfen Sie daher unbedingt den Verschleiß der Bremsbeläge und das Vorhandensein von Undichtigkeiten im Bremskreis.

Wenn der Bremsflüssigkeitsstand plötzlich sinkt, lassen Sie das Fahrzeug von einem *Italjet*-Händler überprüfen, bevor Sie es weiter benutzen

5.1.n Bremsflüssigkeit wechseln

Lassen Sie die Bremsflüssigkeit alle 2 Jahre von einem *Italjet*-Händler wechseln. Lassen Sie außerdem die Dichtungen der Hauptbremszylinder und Bremssättel sowie die Bremschläuche in den unten aufgeführten Intervallen oder früher erneuern, wenn sie beschädigt oder undicht sind

- Bremsendichtungen: alle 2 Jahre
- Bremsschläuche: alle 4 Jahre

5.1.o Keilriemen prüfen

Der Keilriemen muss von einem *Italjet*-Händler in den in der Wartungstabelle angegebenen Intervallen überprüft und/oder ausgetauscht werden.



5.1.p Hauptständer und Seitenständer prüfen und schmieren

Überprüfen Sie regelmäßig die Funktion des Hauptständers und Seitenständers und schmieren Sie die Führungsstifte (1) und Metall-Metall-Kontaktflächen, falls erforderlich.

⚠️ WARNUNG

Wenn sich der Hauptständer oder Seitenständer nicht leicht anheben oder absenken lässt, lassen Sie ihn von einem *Italjet*-Händler überprüfen oder reparieren.

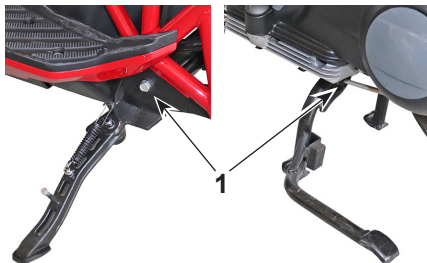

5.1.q Einstellung der Federvorspannung der Stoßdämpfer

Die vorderen (1) und hinteren (2) Stoßdämpfer lassen sich in der Federvorspannung einstellen; zum Einstellen die Kontermutter (3) lösen und die Ringmutter (4) drehen; durch Festziehen wird die Vorspannung erhöht, umgekehrt wird sie verringert.

Durch das Zuschrauben der Ringmutter wird die Feder komprimiert und somit eine steifere Stoßdämpfungswirkung erzielt.

Durch das Aufschrauben der Ringmutter wird die Feder entlastet und Sie haben somit eine weichere Dämpfung.

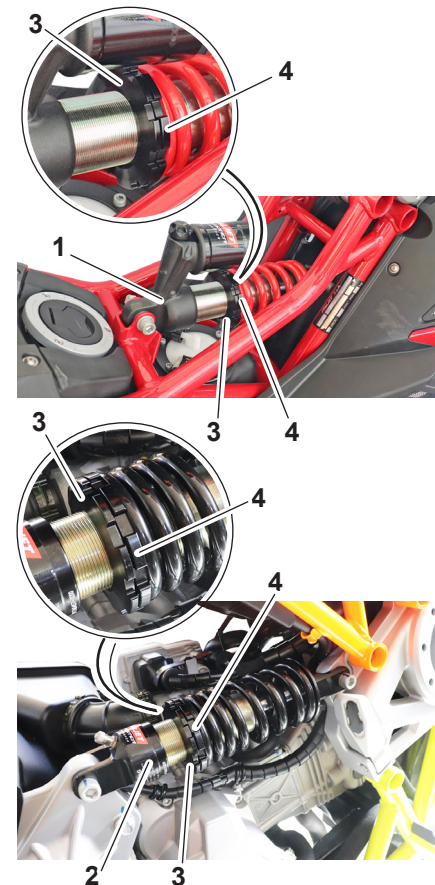



5.1.r Einstellung des vorderen Bremsstoßdämpfers

- Die Bremswirkung durch Drehen der Ringmutter (1) einstellen, durch Drehen in Richtung „+“ wird die Bremswirkung erhöht, durch Drehen in Richtung „-“ wird die Bremswirkung verringert.

Die Werkseinstellung ist 6 Klicks von vollständig geschlossen entfernt.

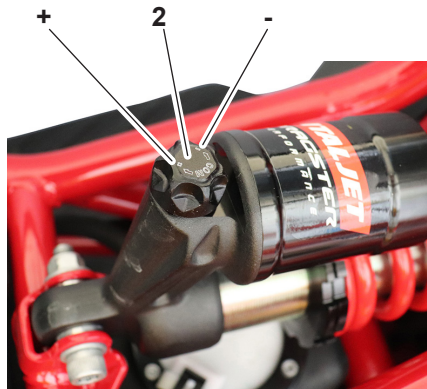

5.1.s Lenksäulenprüfung vorne

Die Lenksäule sollte regelmäßig auf Spiel überprüft werden.

- Motorrad auf den Mittelständer stellen, eine Person muss den Motorradlenker stabil halten und eine andere Person muss versuchen, das Rad (1) in Pfeilrichtung "A" und in Pfeilrichtung "B" zu bewegen.

Wenn übermäßiges Spiel festgestellt wird, wenden Sie sich an einen **Italjet**-Händler, um die Lenkbewegung (2) zu überprüfen.

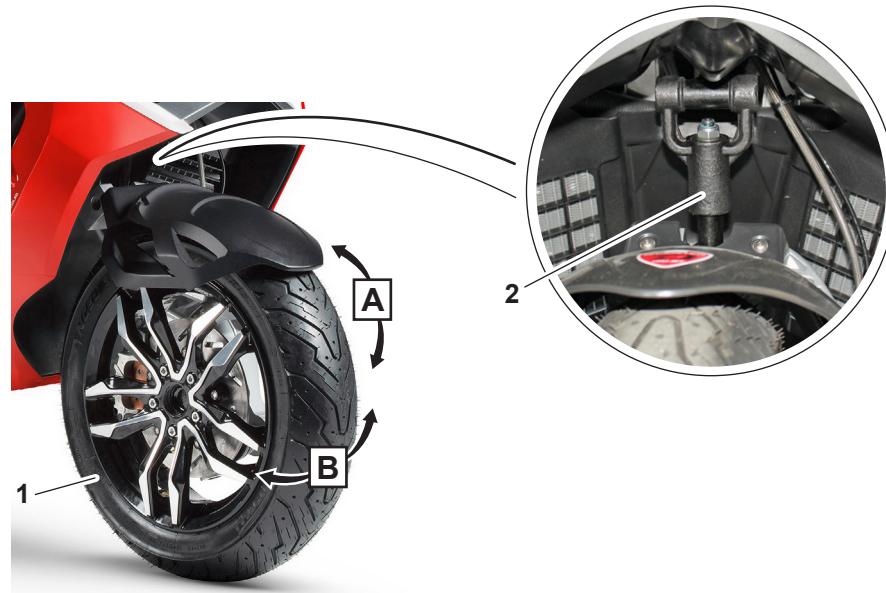



5.1.t Batterie prüfen und laden

Um an das Batteriefach zu gelangen, gehen Sie wie folgt vor:

- Heben Sie den Sattel wie im entsprechenden Absatz beschrieben an.
- Die beiden Schrauben (1) lösen und den Beifahrersitz (2) abnehmen.

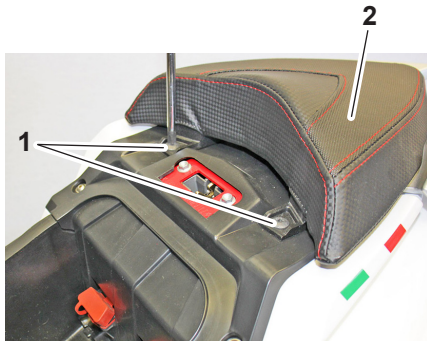

- Die beiden Schrauben (3) lösen und das Gehäuse (4) abnehmen.

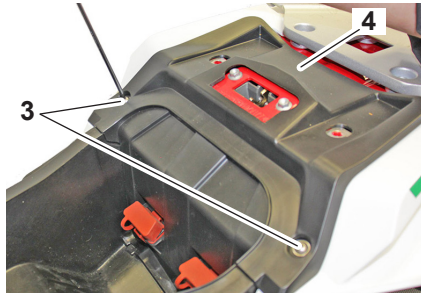

- Entfernen Sie zuerst das SCHWARZE Minuskabel (5) und dann das ROTE Pluskabel (6) (beim Zusammenbau zuerst das ROTE Pluskabel anschließen, dann das SCHWARZE Minuskabel).
- Batterie (7) aus dem Gehäuse nehmen.

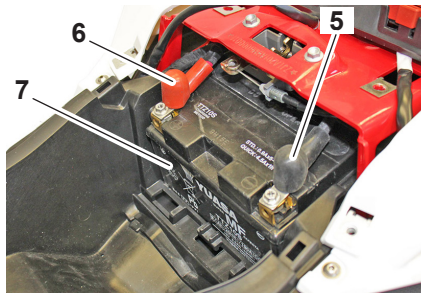

- Überprüfen Sie mit Hilfe eines Voltmeters, dass die Spannung desselben nicht weniger als 12,5V beträgt. Wenn nicht, benötigt die Batterie einen Ladezyklus.

- Verbinden Sie mit einem Konstantspannungs-Batterieladegerät zuerst das ROTE Pluskabel mit dem Pluspol der Batterie und dann das SCHWARZE Minuskabel mit dem Minuspol derselben.

- Prüfen Sie immer den Ladezustand der Batterie, bevor Sie sie wieder in das Fahrzeug einbauen. Die Batterie muss sauber gehalten und die Pole gefettet werden.

>>>





- Alles wieder zusammenbauen, indem man in umgekehrter Reihenfolge wie beim Zerlegen vorgeht; dabei darauf achten, dass der Haken (8) des Beifahrersitzes in den Sitz (9) der Halterung einrastet.

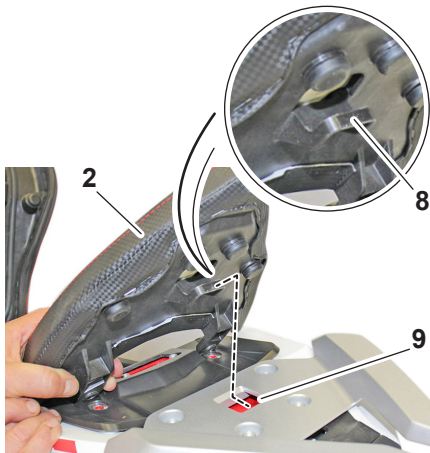

! ACHTUNG

Die Batterie enthält Schwefelsäure. Kontakt mit Haut, Augen und Kleidung vermeiden.

Heilmittel:

KONTAKT MIT DER HAUT

Gründlich mit Wasser ausspülen.

EINNAHME:

Trinken Sie große Mengen Wasser und Milch.

Rufen Sie sofort einen Arzt an. Kein Erbrechen herbeiführen.

KONTAKT MIT DEN AUGEN

Mindestens 15 Minuten mit Wasser spülen und einen Arzt aufsuchen.

ACHTUNG

Wird die Batterie nicht verwendet, muss sie auf jeden Fall mindestens alle 3 Wochen mit einem langsamen Ladezyklus (0,6 A für 8 Stunden bei 12V-6Ah) aufgeladen werden.

! WARNUNG

Batterien erzeugen explosive Gase. In Innenräumen müssen Sie den Raum beim Laden der Batterie gut lüften. Wenn Sie ein Akkuladegerät verwenden, schließen Sie die Batterie an das Ladegerät an, bevor Sie es einschalten. Dadurch wird die Bildung von Funken an den Batteriepolen vermieden, die die in der Batterie enthaltenen Gase entzünden könnten.





5.1.u Kontrolle/Austausch von Sicherungen

Das Motorrad ist mit zwei Sicherungskästen ausgestattet, einer unter dem Sitz und einer unter der Frontplatte.

Sicherungen unter dem Sitz

- Heben Sie den Sattel an, um Zugang zum Sicherungskasten (1) zu erhalten.

Sicherung 2 (20 A)= ABS-Motor

Sicherung 3 (15 A)= ABS-Ventil

Sicherung 4 (10 A)= Plus, Instrumententafel, Spannungsregler, Einspritzung

Sicherung 5 (20 A)= Ersatzsicherung

Sicherung 6 (15 A)= Ersatzsicherung

Sicherungen unter der Frontplatte

- Schrauben (1) lösen und obere Verkleidung (2) abnehmen.

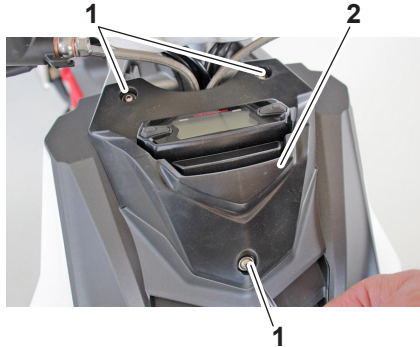

- Ziehen Sie die Blende (3) leicht nach außen, um sie von oben zu lösen.

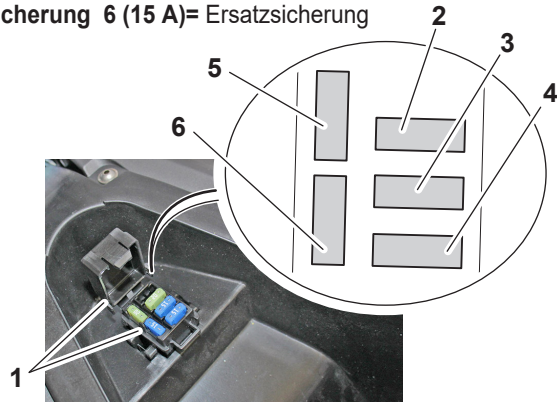
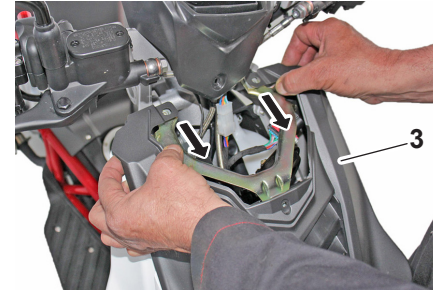

- Nehmen Sie die Blende (3) mit beiden Händen und ziehen Sie sie vom Fahrzeug weg, bis sie sich von der Halterung löst.

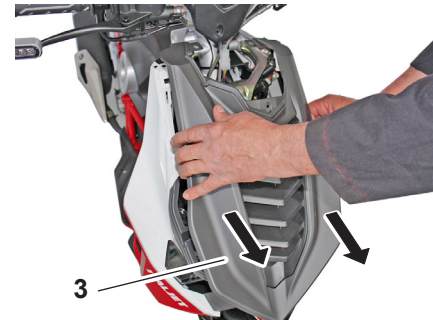



- Der Sicherungskasten (4) befindet sich im oberen rechten Teil des Fahrzeugs.

Sicherung 5 (15A)= Beleuchtung, Kennzeichenbeleuchtung, Blinkerrelais, Hupe
Sicherung 6 (15A)= Einspritzung, Anlasser
Sicherung 7 (15A)= Ersatzsicherung

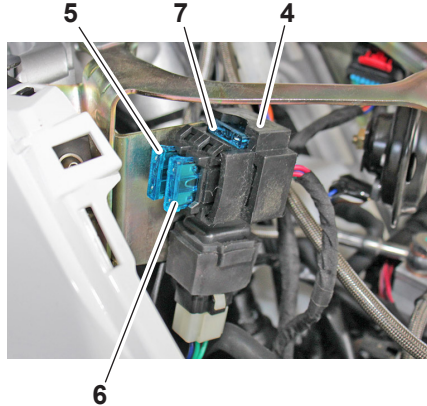

- Alles in umgekehrter Reihenfolge wie beim Zerlegen wieder zusammenbauen; dabei darauf achten, dass die Anschläge (8) der Verkleidung (3) fest in ihren Sitzen (9) sind.

ACHTUNG

Verwenden Sie keine Sicherungen mit einer höheren Stromstärke als die der Originalsicherung, da dies zu Schäden an der elektrischen

Anlage und möglicherweise zu einem Brand führen kann.

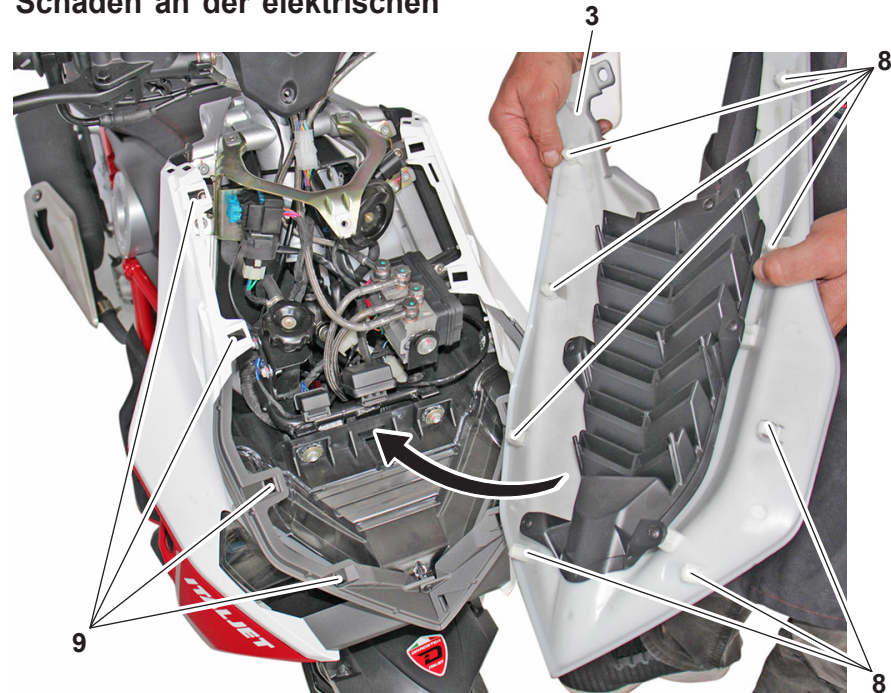



5.1.v Lichtsteuerung

Ausrichtung des vorderen Lichtstrahls

- Um zu überprüfen, ob das Licht richtig ausgerichtet ist, stellen Sie das Fahrzeug mit dem richtigen Reifendruck und einer im Sattel sitzenden Person senkrecht zur Längsachse auf.
- Ziehen Sie vor einer Wand oder einer anderen Fläche in 10 Metern Entfernung zum Motorrad eine horizontale Linie, die der Höhe der Leuchtenmitte entspricht, und eine vertikale Linie, die in einer Linie mit der Längsachse des Fahrzeugs steht.

- Führen Sie die Prüfung möglichst bei schwachem Licht durch.
- Beim Einschalten des Fernlichts darf die obere Grenze der Abgrenzung zwischen dem dunklen Bereich und dem beleuchteten Bereich nicht mehr als $\frac{9}{10}$ der Höhe über dem Boden der Projektormitte betragen.
- Um die richtige Einstellung vorzunehmen, wenden Sie sich an einen **Italjet**-Händler.

Lichter und Fahrtrichtungsanzeiger

- Das Motorrad ist mit LED-Leuchten und -Richtungsanzeigern ausgestattet. Wenn eine Leuchte nicht funktioniert, muss sie beim **Italjet**-Händler ausgetauscht werden.

Diagnosestecker

Um auf die Diagnoseanschlüsse zuzugreifen, heben Sie den Sattel an.

Stecker (1) = ABS-Steuergerät

Stecker (2) = Motorsteuergerät

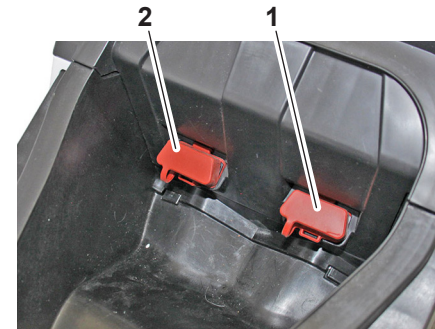
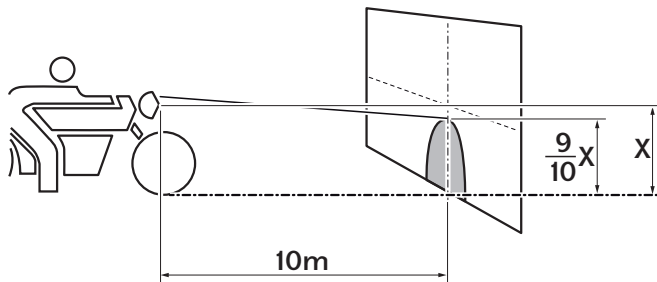



6.1 PFLEGE UND LAGERUNG DES FAHRZEUGS

6.1.a Pflege

Eine regelmäßige und gründliche Reinigung des Fahrzeugs verbessert nicht nur das Erscheinungsbild, sondern erhöht auch die Gesamtleistung und Lebensdauer vieler Komponenten. Darüber hinaus können Sie durch Waschen, Reinigen und Polieren den Zustand des Fahrzeugs häufiger überprüfen. Waschen Sie das Fahrzeug nach Gebrauch im Regen oder in Meeresnähe, da das Salz gegenüber Metallen korrosiv ist.

HINWEIS: Straßen in schneereichen Gebieten können mit Salz bestreut werden, um ein Einfrieren zu verhindern. Dieses Salz kann bis ins späte Frühjahr auf den Straßen verbleiben. Waschen Sie daher den Unterboden und die Fahrwerkskomponenten nach dem Einsatz des Fahrzeugs in solchen Gebieten.

WARNUNG

Eine unzureichende Reinigung kann zu ästhetischen und mechanischen Schäden führen. Verwende nicht:

- Hochdruckreiniger oder Dampfstrahlreiniger. Übermäßiger Wasserdruck kann zum Eindringen von Wasser und zur Beschädigung von Radlagern, Bremsen, Getriebedichtungen und elektrischen Geräten führen.
- Aggressive Chemikalien, scheinende Reinigungsmittel oder Wachs an satinierten oder matten Bauteilen. Bürsten können das Finish zerkratzen und beschädigen; Verwenden Sie nur weiche Schwämme oder Handtücher.

- Handtücher, Schwämme oder Bürsten, die mit scheuernden Reinigungsmitteln oder aggressiven Chemikalien wie Lösungsmitteln, Benzin, Rostschutzmittel, Bremsflüssigkeit, Frostschutzmittel usw. verunreinigt sind.





6.1.b Waschen

Vor

1. Fahrzeug vor direkter Sonneneinstrahlung schützen und abkühlen lassen.
Dies verhindert die Bildung von Kalkflecken.
2. Prüfen Sie, ob alle Stecker, Abdeckungen und elektrischen Verbindungselemente richtig installiert sind.
3. Achten Sie darauf, dass kein Wasser in den Schalldämpfer eindringen kann.
4. Entfernen Sie Straßenschmutz und Ölflecken mit einem hochwertigen Entfettungsmittel und einer Bürste mit Kunststoffborsten oder einem Schwamm.

Während

1. Spülen Sie alle Spuren des Entfetters unter fließendem Wasser ab. Vermeiden Sie es, Wasser direkt in den Schalldämpfer, auf die Instrumententafel, in den Lufteinlass oder in andere Innenräume, wie zum Beispiel die Staufächer unter dem Sattel, zu spritzen.
2. Waschen Sie das Motorrad mit einem hochwertigen Autoreiniger gemischt mit frischem Wasser und einem weichen Schwamm. Verwenden Sie eine gebrauchte Zahnbürste oder eine Bürste mit Kunststoffborsten, um schwer zugängliche Stellen zu reinigen.

ACHTUNG

Wenn das Fahrzeug Salz ausgesetzt war, verwenden Sie kaltes Wasser. Heißes Wasser erhöht die korrosiven Eigenschaften des Salzes.

3. SciacMit klarem Wasser gut abspülen. Entfernen Sie alle Waschmittelreste; könnte schädlich für Kunststoffteile sein.

Nach

1. Trocknen Sie das Fahrzeug vollständig ab.
2. Polieren Sie die Chrom-, Aluminium- und Edelstahloberflächen mit einem entsprechenden Produkt.
3. Tragen Sie Korrosionsschutzspray auf alle Metallkomponenten auf, einschließlich verchromter oder vernickelter Oberflächen.

⚠️ WARNUNG

Keine Sprays auf Silikon- oder Ölbasis auf Sättel, Griffe, Gummifußrastenhalterungen, Bremsscheiben oder Reifenlaufflächen auftragen. Andernfalls werden die Bauteile rutschig, wodurch Sie die Kontrolle über das Fahrzeug verlieren können. Reinigen Sie die Oberflächen dieser Komponenten gründlich, bevor Sie das Fahrzeug benutzen.



4. Behandeln Sie Gummi-, Vinyl- und unlackierte Kunststoffteile mit einem geeigneten Pflegemittel.
5. Verteilen Sie ein nicht scheuerndes Wachs auf allen lackierten Oberflächen.
6. Nach der Reinigung den Motor starten und einige Minuten im Leerlauf laufen lassen, um die Restfeuchtigkeit zu trocknen.
7. Lassen Sie das Fahrzeug vollständig trocknen, bevor Sie es abstellen oder abdecken.

WARNUNG

Auf Bremsen oder Reifen verbleibende Fremdkörper können dazu führen, dass Sie die Kontrolle über das Fahrzeug verlieren.

- **Stellen Sie sicher, dass sich weder Schmiermittel noch Wachs auf den Bremsen oder Reifen befinden.**
- **Waschen Sie die Reifen bei Bedarf mit warmem Wasser und einem neutralen Reinigungsmittel.**
- **Reinigen Sie bei Bedarf die Bremsscheiben und Beläge mit einem speziellen Sprühreiniger.**
- **Testen Sie nach dem Waschen des Fahrzeugs die Wirksamkeit der Bremsen.**

6.1.c Lagerung

Lagern Sie das Fahrzeug immer an einem kühlen, trockenen Ort. Falls erforderlich, schützen Sie es vor Staub, indem Sie es mit einer durchlässigen Folie abdecken.

Stellen Sie sicher, dass der Motor und die Auspuffanlage abgekühlt sind, bevor Sie das Motorrad abdecken.

ACHTUNG

Um Korrosion zu vermeiden, vermeiden Sie feuchte Keller, Tierheime (aufgrund von Ammoniak) und Umgebungen, in denen starke Chemikalien gelagert werden.



6.1.d Längere Lagerung

Bevor Sie das Fahrzeug über einen längeren Zeitraum (60 Tage oder mehr) abstellen, gehen Sie wie folgt vor:

1. Wartungsarbeiten durchführen.
2. Reinigen Sie das Motorrad.
3. Füllen Sie den Kraftstofftank durch Zugabe von Kraftstoffstabilisator gemäß den Produkthanweisungen. Lassen Sie den Motor 5 Minuten lang laufen, um den behandelten Kraftstoff im Kraftstoffsystem zu verteilen.
4. Schmieren Sie den Seitenständer (falls vorhanden) und den Hauptständer.
5. Prüfen und stellen Sie den Reifendruck wieder her und heben Sie dann das Fahrzeug an, sodass die Räder vom Boden abheben.
6. Decken Sie den Abfluss mit einer Plastiktüte ab, um das Eindringen von Feuchtigkeit zu verhindern.
7. Entfernen Sie die Batterie und laden Sie sie vollständig auf oder schließen Sie ein Erhaltungsladegerät an, um eine optimale Batterieladung aufrechtzuerhalten.

ACHTUNG

Prüfen Sie, ob Akku und Ladegerät kompatibel sind.

HINWEIS: Wenn die Batterie entfernt wird, laden Sie sie einmal im Monat auf und lagern Sie sie an einem Ort mit gemäßigter Temperatur von 0-30°C (32-90 °F).





7.1 TECHNISCHE DATEN

maximale Länge	1885 mm
maximale Breite	750 mm
maximale Höhe	1075 mm
Sitzhöhe	760 mm
Radstand	1350 mm
Mindesthöhe vom Boden	120 mm
Leergewicht	150 kg
Maximale Fahrzeugbeladung (Fahrer + Beifahrer + Gepäck)	305 kg
Höchstgeschwindigkeit	124 km/h
Motoröl	1300 cm ³ (Erstbefüllung) 1250 cm ³ (Motoröl & Filter ersetzen) 1200 cm ³ (nur Motoröl wechseln)
Getriebeöl	250 cm ³
Kältemittel	1,15 l (50% Wasser + 50% Ethylenglykol-Frostschutzmittel)
Sitzplätze	2
Getriebe	stufenloser automatischer Variator
Schaltung	Drehzahlminderer und Riemen
Rahmentyp	hochbeständiger Stahlrohrrahmen, vorderer Einzelträger, hintere doppelte überlappende Schwinge.
Lenkwinkel	27.5°

>>>>>





Vorderradaufhängung	unabhängiges Lenksystem
Federweg vorne	33 mm
Federung hinten	Mono-Stoßdämpfer
Federweg hinten	47 mm
Frontscheibe	Ø 200 mm Scheibenbremse mit hydraulischer Übersetzung
Hintere Scheibe	Ø 220 mm Scheibenbremse mit hydraulischer Übersetzung
Felgen, Radkranz	Leichtmetallfelgen
Felge vorne	MT 3.50 x 12"
Hinterradfelge	MT 4.00 x 13"
Reifentyp	ohne Schlauch (Tubeless)
Vorderrad	120/70 - 12" 51 P (120/70-12 M/C, 58S)
Hinterreifen	140/60-13" M/C 63P (140/60-13 M/C 63S)
Standardreifenluftdruck vorne	190 kPa (1.9 bar)
Standardreifenluftdruck hinten	200 kPa (2.0 bar)
Standardreifenluftdruck vorne mit Beifahrer	210 kPa (2.1 bar)
Standardreifenluftdruck hinten mit Beifahrer	250 kPa (2.5 bar)
Batterie	12V - 8.6Ah
Sicherungen	20 - 15 - 15 - 15 - 15 - 10 A
Lichtmaschine (Permanentmagnettyp)	12 V - 300W a 8000 rpm



Technische Daten des Motors (300CC)

Modellmotor	AZC
Motortyp	Wassergekühlter 4-Takt-Einzylinder, 4 Ventile pro Zylinder mit obenliegender Nockenwelle
Nettoleistung max.	17 kW (8000 r/min)
maximales Drehmoment.	23 N•m (6000 r/min)
Hubraum	278 cc
Bohrung/Hub	75 mm x 63 mm
Kompressionsrate	11 : 1
Starter	Elektrisch
Leerlauf	1700 ± 170 rpm
Kupplung	Automatische Fliehkraft-Trockenkupplung
Schaltung	Automatisch
Kühlung	Flüssigkeitskühlsystem mit Kühler und elektrischem Lüfter
Einspritzung	Elektronische Einspritzung
Drosselklappendiffusor	Ø 32 mm
Kraftstoff	Super bleifreies Benzin, Mindestoktanzahl 95 (NORM)
Zündart	Elektronisch
Zündkerze	NGK CR8EKB



8.1 TABELLE DER EMPFOHLENE PRODUKTE

Produkt	Beschreibung	Eigenschaften
Halbsynthetisches oder synthetisches Motoröl	Motoröl	SAE 5W-40 JASO MA, MA2 API SL ACEA A3
Halbsynthetisches oder synthetisches Motoröl	Getriebeöl	SAE 80W/90 75W/90 GL-4 / GL-5
Schmiermittel L-XCDBB2	Lithiumfett mit Molybdän für Lager und andere Stellen, die geschmiert werden müssen	NLGI 2
Bremsflüssigkeit DOT4	Bremsflüssigkeit	FMVSS DOT4
Motorschmiermittel/Kühlmittel FD-2B	Kühlmittel OAT (organic acid technology)	Frostschutz bis -40°C. Entspricht dem CUNA 956-16-Standard.
Schmiermittel/Motoröl 5W-30	Luftfilterschwammöl	-
NEUTRAL-ODER BENZINHALTIGES FETT	Batteriepole	-



DE - 70





9.1 GARANTIE- UND SERVICEBUCH

DE - 71





9.1.a Inhalt der Garantie

Ihr neues Fahrzeug ist gemäß **Richtlinie 99/44 EG** garantiert frei von Originalmängeln.

Die Garantie besteht im kostenlosen Austausch oder der Reparatur des Fahrzeugs oder von Komponenten, die innerhalb der vorgenannten Frist Herstellungsfehler aufweisen oder in jedem Fall bereits bei der Übergabe des Fahrzeugs vorhanden waren.

Die Garantie ist nur gültig, wenn bei Ihrem Fahrzeug der empfohlene Wartungsplan befolgt wurde und alle Coupons ordnungsgemäß abgestempelt wurden.

Wir erinnern Sie daran, dass die Garantie bei Verwendung des Fahrzeugs im Motorradrennsport nicht gilt, da es sich um eine andere Verwendung handelt und nicht mit der Verwendung vereinbar ist, für die Ihr Fahrzeug speziell konzipiert wurde.

Denken Sie daran, dass diese Garantie, wie gesetzlich vorgeschrieben, direkt von Ihrem **Italjet**-Händler gewährt wird, an den Sie sich unserer Empfehlung nach wenden sollten.

Wenn Ihr **Italjet**-Händler Ihre Anfragen nicht innerhalb einer angemessenen Zeit erfüllen kann oder es anders für Sie bequemer ist, empfehlen wir Ihnen, sich an einen anderen **Italjet**-Händler zu wenden, der Ihnen gerne zur Verfügung steht

9.1.b Inbetriebnahme des Fahrzeuges

Für Ihr Fahrzeug gilt ab dem Zeitpunkt der Auslieferung durch Ihren **Italjet**-Händler eine Garantie gegen Originalmängel.

Wenn Sie Ihr **Italjet**-Fahrzeug erhalten, bitten wir Sie, zusammen mit dem Händler den in diesem Handbuch enthaltenen Fahrzeugübergabeschein zu unterschreiben.

9.1.c Verhalten im Garantiefall

Für den Fall, dass Ihr Fahrzeug während der Garantiezeit aufgrund eines Originalfehlers eine außerordentliche Reparatur und/oder einen Austausch erfordert, empfehlen wir Ihnen, sich sofort an den Händler, bei dem Sie das Fahrzeug gekauft haben, zu wenden und das aufgetretene Problem zu beschreiben; er begutachtet das Fahrzeug.

Wird der Eingriff durch das Auftreten eines Originalfehlers erforderlich, führt Ihr Händler die erforderliche Reparatur oder den Austausch in kürzester Zeit kostenlos durch.

9.1.d Garantiebedingungen

Ausschlüsse

Von der Garantie ausgeschlossen sind:

- Verschlechterung aufgrund der Nichteinhaltung des von **Italjet** vorgeschriebenen periodischen Wartungsplans.
- Fahrzeuge, deren Reparaturen mit nicht originalen Ersatzteilen durchgeführt wurden.
- Fahrzeuge, für die der periodische Wartungsplan nicht durchgeführt wurde oder für die die Coupons nicht ordnungsgemäß abgestempelt wurden.
- Fahrzeuge, die für Rennsport/Vermietung/schwere Offroad-Einsätze verwendet werden.

Verbrauchs- und Verschleißteile:

Die Garantie erstreckt sich nicht auf den normalen Verschleiß, der durch die Verwendung des Fahrzeugs für die folgenden Teile verursacht wird:

- Zündkerze
- Antriebs- und Übertragungsketten
- Bremsbeläge und -scheiben
- Kupplungsscheiben und Massen
- Reifen
- Lampen und Sicherungen
- Übertragungs- und Steuerkabel
- Schläuche und alle anderen Gummiteile
- Lager
- Luft- und Benzinflter
- Riemen und Zahnräder des Sekundärgetriebes.



Schmierstoffe

Die Garantie erstreckt sich nicht auf Flüssigkeiten: Öl, Fett, Batteriesäure und Kühlmittel.

Einschränkungen

Für alle Fahrzeuge: Die Garantie der Batterie, des Sitzes und der Plastikteile ist auf 6 Monate begrenzt.

- Die Garantie deckt weder Wartungs- und Überholungskosten noch die Kosten der für diese Arbeiten erforderlichen Teile.
- Die Garantie deckt nicht die Kosten, die sich aus dem Garantierantrag ergeben, wie: zusätzliche Kosten für Kommunikation, Unterkunft und Verpflegung oder andere abgeleitete Kosten wie Entschädigung für verlorene Zeit, gewerbliche Verluste, Mietkosten für Ersatzfahrzeuge, Transport.

Wichtiger Hinweis zur Gültigkeit der Garantie:

- Das Garantieheft ist sorgfältig aufzubewahren und bei jedem Eingriff dem offiziellen **Italjet**-Händler vorzulegen.
- Die Inspektionscoupons müssen von dem Händler ausgefüllt werden, der den Eingriff durchgeführt hat.
- Die Garantie kann bis zu ihrem Ablauf auf Nachbesitzer übertragen werden.
- Verwenden Sie im Falle eines Besitzerwechsels den speziellen Coupon in dieser Broschüre.
- Der Hersteller behält sich das Recht vor, Änderungen und/oder Verbesserungen an allen seinen Modellen vorzunehmen, ohne dass er verpflichtet ist, diese Änderungen an bereits im Verkehr befindlichen Fahrzeugen vorzunehmen.



Multiple horizontal dotted lines for text entry, arranged in a series down the page.





LIEFERZERTIFIKAT

Datum:

Rahmen-Nr.:

Modell:

Motor-Nr.:

Das Motorrad wurde für die Auslieferung vorbereitet, indem alles von ITALJET S.P.A. und mit vom Kunden gewünschtem optionalem Zubehör ergänzt wurde.

Der Kunde hat dieses Garantieheft und das Betriebs- und Wartungshandbuch erhalten und die wichtigsten mit dem Fahrzeug gelieferten Antriebsvorrichtungen sind abgebildet.

Stempel und Unterschrift des Händlers

Die offizielle Verkaufsorganisation und die Gesellschaft ITALJET S.P.A erklären, dass die Verarbeitung der personenbezogenen Daten des Käufers unter Bezugnahme auf das Gesetz Nr. 675 von 1996 und spätere Änderungen auch ohne Zustimmung des Kunden erfolgen kann, um der Verpflichtung zum Service nachkommen zu können.



KUNDE

Vorname: _____

Nachname: _____

Adresse: _____

Stadt: _____

Postleitzahl: _____

Telefonnummer: _____

Ich erkläre, heute das oben genannte Motorrad vollständig und meinen Erwartungen entsprechend erhalten zu haben; ebenso erhalten habe ich dieses Garantieheft und die Gebrauchs- und Wartungsanleitung. Ich ermächtige ITALJET S.P.A. zur Verarbeitung meiner personenbezogenen Daten zum Zweck der Bereitstellung des Servicedienstes gemäß Gesetz 675/1996 und nachfolgenden Änderungen.

Unterschrift des Kunden

Kopie für ITALJET S.P.A.



A series of 12 horizontal dotted lines, evenly spaced, providing a guide for text entry.



DE - 76





MITTEILUNG DES EIGENTUMSÜBERTRAGS

Datum: Km:

Rahmennummer:

Modell:

Motor Nr:

Unterzeichnende/r: _____

Vorname: _____

Nachname: _____

Adresse: _____

Stadt: _____ Postleitzahl: _____

Telefonnummer: _____

In verschlossenem Umschlag senden an:
ITALJET S.P.A. , Via dell'agricoltura, 2 - 40023 Castel Guelfo di Bologna (BO) - Italien

Die offizielle Verkaufsorganisation und die Gesellschaft ITALJET S.P.A erklären, dass die Verarbeitung der personenbezogenen Daten des Käufers unter Bezugnahme auf das Gesetz Nr. 675 von 1996 und spätere Änderungen auch ohne Zustimmung des Kunden erfolgen kann, um der Verpflichtung zum Service nachkommen zu können.



KUNDE



ITALJET S.P.A. überträgt hiermit das Eigentum an dem oben genannten Fahrzeug an Herr/ Frau:

Vorname: _____

Nachname: _____

Adresse: _____

Stadt: _____

Postleitzahl: _____

Telefonnummer: _____

Lieferung dieser Garantiebroschüre und des mitgelieferten Gebrauchs- und Wartungshandbuchs

Kopie für ITALJET S.P.A.

DE - 77





Area with horizontal dotted lines for text entry.





Platz zum Aufbewahren der Steuerunterlagen, die die Ausführung der geplanten Wartungsscheine belegen.



COUPON	<input type="text"/>	DATUM	<input type="text"/>	km	<input type="text"/>	Unterschrift des Kunden	<input type="text"/>	Händlerstempel	<input type="text"/>
COUPON	<input type="text"/>	DATUM	<input type="text"/>	km	<input type="text"/>	Unterschrift des Kunden	<input type="text"/>	Händlerstempel	<input type="text"/>
COUPON	<input type="text"/>	DATUM	<input type="text"/>	km	<input type="text"/>	Unterschrift des Kunden	<input type="text"/>	Händlerstempel	<input type="text"/>
COUPON	<input type="text"/>	DATUM	<input type="text"/>	km	<input type="text"/>	Unterschrift des Kunden	<input type="text"/>	Händlerstempel	<input type="text"/>
COUPON	<input type="text"/>	DATUM	<input type="text"/>	km	<input type="text"/>	Unterschrift des Kunden	<input type="text"/>	Händlerstempel	<input type="text"/>
COUPON	<input type="text"/>	DATUM	<input type="text"/>	km	<input type="text"/>	Unterschrift des Kunden	<input type="text"/>	Händlerstempel	<input type="text"/>
COUPON	<input type="text"/>	DATUM	<input type="text"/>	km	<input type="text"/>	Unterschrift des Kunden	<input type="text"/>	Händlerstempel	<input type="text"/>
COUPON	<input type="text"/>	DATUM	<input type="text"/>	km	<input type="text"/>	Unterschrift des Kunden	<input type="text"/>	Händlerstempel	<input type="text"/>
COUPON	<input type="text"/>	DATUM	<input type="text"/>	km	<input type="text"/>	Unterschrift des Kunden	<input type="text"/>	Händlerstempel	<input type="text"/>
COUPON	<input type="text"/>	DATUM	<input type="text"/>	km	<input type="text"/>	Unterschrift des Kunden	<input type="text"/>	Händlerstempel	<input type="text"/>

FIXIEREN Sie mit einer Büroklammer oder einem Hefter die Steuerquittung oder die Quittung, die bestätigt, dass die Wartungscoupons ausgeführt wurden.









Cod. 8351398 - Ed. 11/2023 - Rev. 00

DRAGSTER



ITALJET S.P.A
Via dell'Agricoltura 2
40023 Castel Guelfo di Bologna (BO), Italia

